



SINCE 1990

HWANG CHERNG BIN Specialty Tools Inc.

SPECIAL TOOLS FOR TRUCK

卡車特殊修護工具

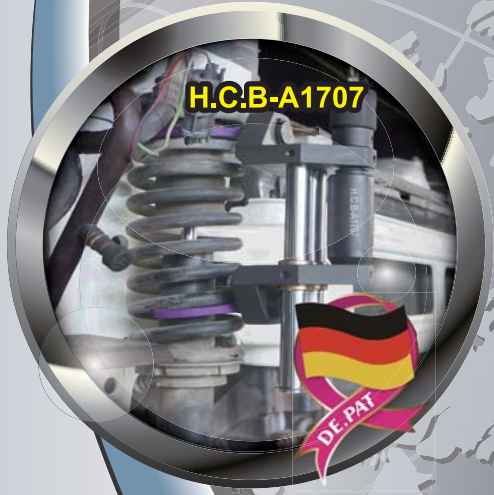

H.C.B-A1707



H.C.B-A1773



H.C.B-A1853



H.C.B-E1181



H.C.B-A1837



The Director of the United States Patent and Trademark Office

This certifies that the application for a patent in the name of Hwang Ching Bin, Taiwan, Republic of China, and the invention of the specialty tools for truck repair, as shown in the enclosed drawings, and the priority date of the same, have been examined and found to be new, useful, and non-obvious, and that the same are entitled to the patent therefor.

Witness my hand and the seal of the Patent and Trademark Office, at Washington, D.C., this 15th day of August, 2011.

United States Patent

Given to the inventor herein title to the patent for the right to make, use, and dispose of the invention herein, and the right to exclude others from making, using, or selling the same, or to import the same into the United States, subject to the payment of the full amount of the issue fee, and to the payment of the maintenance fee as provided for in the statute.

If the application was filed on or after June 8, 2009, the term of the patent in the United States shall be the term of the patent in the country of origin plus 20 years from the date of filing of the application in the United States, subject to the payment of the maintenance fee as provided for in the statute.

If the application was filed on or after June 8, 2009, the term of the patent in the United States shall be the term of the patent in the country of origin plus 20 years from the date of filing of the application in the United States, subject to the payment of the maintenance fee as provided for in the statute.

If the application was filed on or after June 8, 2009, the term of the patent in the United States shall be the term of the patent in the country of origin plus 20 years from the date of filing of the application in the United States, subject to the payment of the maintenance fee as provided for in the statute.

J.W.D.



H.C.B is the only truck repair tool R&D company in Taiwan and gets government subsidies for designing new tools.



SINCE 1990

HWANG CHERNG BIN
Specialty Tools Inc.

Quick Reference



P2~86

European Truck Repair Tool

歐系卡車修護工具



P88~98

IVECO Truck Repair Tool

IVECO 卡車修護工具



P100~128

Japanese Truck Repair Tool

日系卡車修護工具

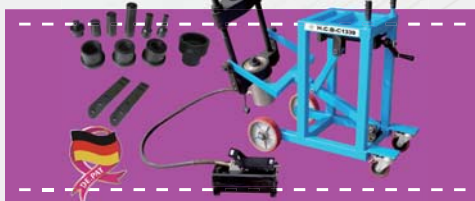

P130~199

General Truck Repair Tool

通用卡車修護工具



P201~208

Air Power Tools

氣動工具



P210~220

General Repair Equipment

一般修護工具 修護設備

COMPANY PROFILE

HWANG CHERNG BIN (H.C.B) Specialty Tools Inc, was founded in 1990, and served as an very important supplier of automotive tools / truck tools in the world. H.C.B focuses on developing special tools for Mercedes-Benz, BMW, Volkswagen, Audi, Volvo, Scania, Man, Hino, Isuzu, Honda, Toyota....., etc. Those tools are for chassis, engine, transmission, panel, wheels repair, and especially for chassis. There have been over 1600 products in H.C.B's catalogue which can meet most mechanics' needs.

Factory of H.C.B covering around 4000 square meters consists of testing lab, R&D lab, sample room, international sales office, training room, and employee lounge room. Those facilities give great benefits to employees to work with high efficiency.

H.C.B is a world-famous automotive/truck tool supplier due to its products' stable high quality, innovation and variety. H.C.B's products have great quality because of more than 25-year experience in producing automotive tools. Besides H.C.B has a professional test lab for testing products before shipping to make sure the products which customers receive are intact. Additionally, H.C.B earns ISO 9001/CE/TUV approval to ensure the excellent quality. H.C.B has R&D team and R&D lab as well to develop new tools on its own. Not only developing new tools by itself, but also working with its customers and workshop mechanics, in order to solve their vehicle repair problems and find inspiration of new tools. Thanks to R&D team, and cooperation with customers, HCB has developed over 1600 products. Furthermore, to create products' uniqueness and value, H.C.B has more than 80 patents in USA, Germany, Japan, and Taiwan. Moreover, H.C.B is the only manufacturer in Taiwan and the only few manufacturers in the world which produces truck tools. As a result of the reliable quality, various, unique and valuable products, H.C.B has supplied automotive/truck tools to over 60 different markets across all continents in the planet.

The goal of H.C.B is to develop and supply the optimal automotive/truck tools which can make vehicle repair quicker, easier, safer and more economical to solve the problem of vehicle repair and help mechanics all over the world.





Company History

27 years of quality insisting and R&D



1990
~
1999



- ◆ 創立鉅祥工業社(董事長 黃盛彬 先生)(1990.5.1)
Mr. Hwang Cherng Bin built up Gu Siang industrial Co.
台灣嘉義縣にて鉅祥工業社として黃盛彬が会社創設・創業者 黃盛彬 会長に就任 (1990.5.1)
- ◆ 開始代工多國品牌汽修工具
Started out doing OEM works for many countries.
自動車用修復工具の改良ニーズへの対応OEM・海外代理店問合せを始める。
- ◆ 開發第一組 BENZ底盤修護工具(H.C.B-A1001) USA.PAT. (1998.7.20), 迄今約有80多項專利(含歐、美、日)
Develop first BENZ chassis repair tool(H.C.B-A1001) USA.PAT. (1998.7.20), and awarded 80 patents from Germany, America, Japan and Taiwan.
ベンツシャーシ修復ツールの開発に世界で初めて成功し、80項目の特許を取得しました。米国(1998.7.20)、
德国・日本の特許を取得する。そして多国の実用新型特許を取得した。
- ◆ 以H.C.B品牌在國內市場銷售
Sale H.C.B brand in domestic market.
自動車用修復工具にH.C.Bのマークを使用することを決定。そして市販を開始。
BENZ 工字標鐵套通過專利審查(1999.03.09)
BENZ Suspension bush extractor/installer was awarded patent.
ベンツ(W124/W201)サスペンションブッシュ抽出器の發明專利(台灣)を正式に取得しました。
- ◆ 商標HCB註冊和公司開始參與主要生產專業工具 (1999.09.01)
The trademark H.C.B was registered and the Company became involved mainly in manufacturing professional tools.(1999.09.01)
H.C.B 商標專售特許權を審査成功。

2002
~
2006



- ◆ 開始參加臺北AMPA SHOW展覽與國外展覽, 成功將H.C.B品牌推廣到國際市場
Start to participate in Domestic and international exhibitions and successfully promoting H.C.B brand to international markets.
台北と海外国際展覧会を参りました。国際市販でH.C.Bのブランドを成功発売。
- ◆ 成立鉅祥工具開發有限公司(原鉅祥工業社改制)(2002.4.23)
Founded Gu Siang Tools Develop Co. Ltd (Gu Siang industrial Co. reformed)(2002.4.23)
鉅祥工業社を有限会社鉅祥工具開發と改称。
- ◆ 正式與國立中正大學育成中心簽約合作(2002.8.9)
Formal cooperation with the N.C.C.U (2002.8.9)
台湾の國立中正大学附中小企業創新育成センターと連携に関する協定を締結しました。
- ◆ 榮獲中小企業創新研究獎(嘉義縣工業會)
Awarded Taiwan SMEs Innovation Award (Chiayi County Industrial Associations)
台湾の中小企業庁で革新研究開発一等賞受賞。
- ◆ 榮獲美國專利(H.C.B-A1081 專利可調式皮帶盤支撐扳手)
Awarded USA Patent. (H.C.B-A1081 ADJUSTABLE UNIVERSAL CAMSHAFT PULLEY HOLDING TOOL)
ADJUSTABLE UNIVERSALカムシャフトプルーリー保持具について、米国特許権を取得する。
- ◆ 榮獲德國專利(H.C.B-A1108 VW T4前上三角架球接頭拆裝工具組)
Awarded Germany Patent.(H.C.B-A1108 VW T4 FRONT AXLE UPPER BALL-JOINT EXTRACTOR/INSTALLER)
フロントアクスルアッパーボールジョイント抽出器について、ドイツ特許権を取得する。
- ◆ 入圍國家創新發明獎(H.C.B-A1052雙A鷲羊角校正器(改良型))
Entering National Invention and Creation Award (H.C.B-A1052) DOUBLE WISHBONE ALIGNMENT TOOLS (IMPROVEMENT)
国内で革新研究開発一等賞をファイナリストに。

2009



- ◆ 榮獲AMPA SHOW創新發明獎配件類第一名(H.C.B-A1081專利可調式皮帶盤支撐扳手)
Got first in Taipei AMPA Innovation Awards (H.C.B-A1081 ADJUSTABLE UNIVERSAL CAMSHAFT PULLEY HOLDING TOOL)
アジャスタブルユニバーサルカムシャフトプルーリーホルディングツールとはAMPAの革新一賞を受賞しました。
- ◆ 榮獲由臺北國際汽車零配件展主辦的AMPA SHOW綠色能量推薦產品(H.C.B-A1052雙A鷲羊角校正器(改良型))
Awarded Taipei AMPA SHOW Green Power recommended product (H.C.B-A1052) DOUBLE WISHBONE ALIGNMENT TOOLS (IMPROVEMENT)
HONDA ホンダ修復ツールについて、台北國際自動車産業総合展のAMPA SHOWグリーン化製品をお薦めて最良の選択です。
- ◆ 榮獲由臺北國際汽車零配件展主辦的AMPA SHOW綠色能量推薦產品(H.C.B-A1117 專利齒輪式多功能拆裝架)
Awarded Taipei AMPA SHOW Green Power recommended product (H.C.B-A1117 GEAR TYPE UNIVERSAL K/D RACK)
ギアタイプユニバーサルK型(Dラック特許)について、台北國際自動車産業総合展のAMPA SHOWグリーン化製品をお薦めて最良の選択です。
- ◆ 榮獲由臺北國際汽車零配件展主辦的AMPA SHOW綠色能量推薦產品(H.C.B-A1108 VW T4前上三角架球接頭拆裝工具組)
Awarded Taipei AMPA SHOW Green Power recommended product (H.C.B-A1108 VW T4 FRONT AXLE UPPER BALL-JOINT EXTRACTOR/INSTALLER)
フロントアクスルアッパーボールジョイント抽出器について、台北國際自動車産業総合展のAMPA SHOWグリーン化製品をお薦めて最良の選択です。
- ◆ 投保100萬美元的產品責任險
Insured \$ 1,000,000 product liability insurance
製品責任保險100萬(米ドル)
- ◆ 獲得ISO9001:2008版認證稽核
Obtain ISO 9001: 2008 version certification company
Since 2009 our production processes have complied with the ISO 9001: 2008 Quality System standards
品質マネジメントシステム ISO9001:2008 認証取得。
- ◆ 榮獲嘉義縣政府98地方產業創新研發推動計畫(地方型SBIR)補助(H.C.B-B1337 手動卡車多功能拆裝)
Obtain Chiayi County government local industrial innovation and R & D Promotion Program grants (local type SBIR)
(H.C.B-B1337 TRUCK K/D RACK - ELECTRICAL)
齒車式ユニバーサルK/Dラック(B1337)は台湾の自治區嘉義縣政府地域産業研究開發推進計畫 (SBIR) 公的扶助支援產品。



Company History

27 years of quality insisting and R&D

2010 & 2011

- ◆ 新廠啓用(龍德一廠 2010.2.7)
Start using new factory (Longder First 2010.2.7)
本社の新工場龍德一廠で工場稼働開始。
- ◆ 榮獲中天電視台(今日台灣)節目專題報導(2010.2.13)
Obtain Taiwan Today report of Cti TV (2010.2.13)
台灣的中天新聞台報道特集なかで紹介した掲載頂きました。
- ◆ 榮獲嘉義縣政府99年度地方產業創新研發推動計畫(地方型SBIR)補助(H.C.B A1383 電動鉚釘機)
Obtain Chiayi County government local industrial innovation and R & D Promotion Program grants (local type SBIR) (H.C.B A1383 ELECTRICAL BRAKE LINING SHOE LOADER)
電気ブレーキライニングシューローダーは台湾の自治區嘉義縣政府地域産業研究開発推進計畫(SBIR) 公的扶助支援產品。
- ◆ H.C.B 商標在中國註冊成功(2011.1.28)
Exclusive right to use H.C.B registered trademark in China (2011.1.28)
中國でH.C.Bの商標専売特許權を審査成功。
- ◆ 榮獲100年度經濟部科技研究發展專案協助傳統産業技術開發計畫(CITD)補助
Obtain CITD Program grants in 2011.
經濟部の科学産業技術の發展開發推進計畫(CITD)公的扶助支援產品。
- ◆ 第五次獲得嘉義縣工業會優良會員廠商表揚
Award Excellent Member recognition from Chiayi County Industrial Associations for fifth times.
第五回台灣の嘉義縣工業機構のメンバーの中で最も優れた会社のを表彰する。

2012



- ◆ 以H.C.B品牌 正式進入歐洲市場
Sale H.C.B brand in Europe Markets.
自動車用修復工具にH.C.Bのマークを使用することを決定、そして歐洲市販事業との直接取引開始。
- ◆ 取得 CE認證 (H.C.B-A1383 電動鉚釘機)
電気ブレーキライニングシューローダーは CE證明書を得た。
- ◆ 取得 CE認證 (H.C.B-A8001 多功能剪型氣/油壓引擎拆卸設備)
マルチファンクション油圧/空圧エンジンリフトは CE證明書を得た。
- ◆ 榮獲101年生産革新管理聯合型輔導計畫績優優異表揚
台灣の工業生産管理推進機構育成計畫の取り組みを表彰する。
- ◆ 榮獲台灣發明專利20年 (H.C.B-B1337 電動卡車引擎拆裝架)
齒車式ユニバーサルK/Dラックは台灣の研究開発特許權20年を取得。
- ◆ 榮獲 新型專利號碼 PAT.M 438423(H.C.B-A1410 萬用球接頭拔卸器(39mm))
ユニバーサルトラックボールジョイントリムーバー(39ミリメートル)は商品新型特許權を取得。
- ◆ 榮獲 新型專利號碼 (H.C.B-A1445 獲得新型專利)
ユニバーサルサスペンションアームレバーは商品新型特許權を取得。

2013 & 2014



- ◆ 榮獲 專利 (H.C.B-A1445 撬棒)
Awarded Patent (H.C.B-A1445 UNIVERSAL SUSPENSION ARM LEVER)
ユニバーサルサスペンションアームレバーは特許を取得。
- ◆ 榮獲台灣專利 (H.C.B-A1487 BMW (E81-E88,E90-E93,F2,M3)後游臂鐵套拆裝工具組)
Awarded Taiwan Patent (H.C.B-A1487 BMW (E81-E88,E90-E93,F2,M3) REAR TRAILING ARM BUSHING REMOVER & INSTALLER TOOLS)
BMW (E87/E88/E90-E93/F2/M3)リアトレーリングアームブッシュリムーバーとインストーラツールは台灣の特許を取得。
- ◆ 榮獲德國專利 (H.C.B-B1339 大王銷拆卸機 75噸)
Awarded Germany Patent (H.C.B-B1339 TRUCK KING PIN PRESS 75 TONS)
KING PINとアンカーピンブッシャー(75トン)はドイツの特許を取得。
- ◆ 榮獲美國專利 (H.C.B- B1117 專利引擎拆裝架)
Awarded Germany Patent (H.C.B- B1117 UNIVERSAL ENGINE STAND)
ギアタイプユニバーサルK/Dラックは米國特許を取得。
- ◆ 新廠動工(龍德二廠 2014.3.3)
Start building new company (Longder Second 2014.3.3)
本社の新工場龍德二廠で工場擴增開始。



2016

- ◆ H.C.B 將與萬能工商建教合作培養優秀人才
H.C.B cooperates with Wan-Neng Vocational High School to cultivate talents.
H.C.Bは萬能工商と契約し、優秀な人材の育成をしています。
- ◆ H.C.B與國立中正大學育成中心產學合作
H.C.B with National Chung Cheng University Innovation Incubation center industry-university cooperative project.
H.C.Bは国立中正大學教育センター産學と提携しました。

- ◆ H.C.B-A1117工具獲得全國高中職汽車科學生競賽指定比賽工具
H.C.B-A1117 is a appointed competition tool in domestic Department of Automotive Technology of senior high school.
H.C.BのA1117工具は全國の高校の自動車修理コンテストの指定工具に選ばれました。
- ◆ H.C.B與萬能工商合作承辦104年度高級中等學校職業類科專任教師赴公民營機構研習活動(2015/12/03)。
H.C.B with Wanneng Industrial and Commercial Vocational High School organized the 2015th Senior \High School Vocational Department Full-time Teacher to private and governmental organization Seminar.
H.C.Bと萬能工商協力し、104年度の高校職業專門科專任教師を公民營機構へ派遣し、研修活動を行いました(2015/12/03)。
H.C.B und das Wanneng Industrie- und Wirtschaftsgymnasium organisierten das 2015 Seminar der Oberstufen-Berufsabteilung Vollzeit Lehrer für private und staatliche Organisationen.
- ◆ H.C.B-B2095多功能油壓彈簧避震器拆裝器DE. PAT. 20 2015 107 157 TW PAT. M518188 CE
獲得2016年台北汽機車零配件展 創新產品獎H.C.B-B2095 HYDRAULIC MACPHERSON SPRING DUMPER COMPRESSOR DE. PAT. 20 2015 107 157 TW PAT. M518188 CE awarded with "2016 Taipei AMPA innovation award" H.C.B-B2095, ausgezeichnet mit der "2016 Taipei AMPA Innovation Award"
H.C.B-B2095 マクファーソン油圧式スプリングコンプレッサーダンパー装置DE. PAT. 20 2015 107 157 TW PAT. M518188 CE 2016台北AMPAイノベーションアワード受賞

Company History

27 years of quality insisting and R&D

2017

- H.C.B-K2016 BMW 引擎平衡桿榮獲台灣專利
 Awarded Taiwanese Patent (H.C.B-K2016 BMW ENGINE SUPPORT BAR)
 H.C.B-K2016 BMWエンジンバランスバー台湾の特許を取得PAT. M 534705。
- H.C.B-A1707 VOLVO (FM, FH 500P/540P) 卡車車屋避震器壓縮工具榮獲德國與台灣專利
 Awarded Germany and Taiwanese Patent (H.C.B-A1707 VOLVO (FM, FH 500P/540P) TRUCK SHOCK ABSORBER SPRING COMPRESSOR)
 H.C.B-A1707 VOLVO (FM, FH 500P/540P) トラックハウスショックアブソーバー圧縮工具 ドイツと台湾の特許を取得DE.PAT. 20 2017 101 722 TW PAT. M542590。
- H.C.B-A1664 變速箱卸油工具組 (BENZ 722.6 / 722.9 · BMW 6HP / 8HP) 榮獲台灣專利
 Awarded Taiwanese Patent (TRANSMISSION OIL DRAIN TOOL KIT (BENZ 722.6 / 722.9, BMW 6HP / 8HP))
 H.C.B-A1664 ギアボックスアンロードツールセット (BENZ 722.6 / 722.9 · BMW 6HP / 8HP) 台湾の特許を取得 PAT. M 537183。
- H.C.B 與 萬能工商合作承辦 105 年度高級中等學校職業類科專任教師赴公民營機構研習活動
 H.C.B with Wanneng Industrial and Commercial Vocational High School organized the 2016th Senior High School Vocational Department Full-time Teacher to private and governmental organization Seminar.
 H.C.B と 万能工商協力し、105 年度の高校職業専門科専任教師を公民營機構へ派遣し、研修活動を行いました。
- H.C.B-B1623 TOYOTA (VOXY/VELLFIRE/ALPHARD/ESTIMA/CAMRY/HARRIER/NOAH/PREVIEW/MARK II/ISIS/WISH/PICNI/ALTIS/COROLLA/VIOS/VITZ) 後橋懸掛鐵套拆裝工具組榮獲美國及台灣專利
 H.C.B-B1623 TOYOTA (VOXY/VELLFIRE/ALPHARD/ESTIMA/CAMRY/HARRIER/NOAH/PREVIEW/MARK II/ISIS/WISH/PICNI/ALTIS/PREVIEW/VIOS) REAR-AXLE SUSPENSION BUSH REMOVER/INSTALLER USA PAT. M534073, M535162
 H.C.B-B1623 トヨタ (VOXY/VELLFIRE/ALPHARD/ESTIMA/CAMRY/HARRIER/NOAH/PREVIEW/MARIS II/ISIS/WISH/PICNI/ALTIS/COROLLA/VIOS/VITZ) リアアクスルサスペンションアイアンスリーブ組立工具セット 米国と台湾の特許を取得 PAT. M534073, M535162, M551553

2018

- H.C.B-C2321 萬向球接頭拔卸器 榮獲台灣專利
 H.C.B-C2321 UNIVERSAL CV JOINT PULLER PAT. M555275
 H.C.B-C2321 ユニバーサルボールジョイントブラー 台湾の特許を取得 PAT. M555275
- H.C.B 舉辦第一屆 H.C.B 全國國中籃球盃比賽
 H.C.B held the first "National Junior Hhigh School Basketball Competition".
 H.C.B が最初の H.C.B 全国バスケットボールカップ競技会を開催しました。
- H.C.B-A1795 BMW (E60/E61/E63/E64) 後工字樑前/後鐵套拆裝工具組 榮獲台灣專利
 H.C.B-A1795 BMW (E60/E61/E63/E64) REAR SUBFRAME FRONT/REAR BUSH REMOVAL/INSTALLATION TOOL KIT
 PAT. M561632
- H.C.B-A1795 BMW (E60/E61/E63/E64) リアIビームフロント/リアアイアンスリーブアセンブリツールセット 台湾の特許を取得 PAT. M561632
 H.C.B-A1787 VW T5 後拖曳臂鐵套拆裝工具組 榮獲台灣專利
 H.C.B-A1787 VW T5 REAR TRAILING ARM BUSH REMOVAL/INSTALLATION TOOL KIT PAT. M563983
- H.C.B-A1787 BMW (E60/E61/E63/E64) リアIビームフロント/リアアイアンスリーブアセンブリツールセット 台湾の特許を取得 PAT. M561632



2019

- H.C.B-A1853 大型變速箱培林拔卸器 榮獲台灣專利
 H.C.B-A1853 HEAVY DUTY GEARBOX BEARING PULLER PAT. M574100
 大型ギアボックスパリンプーラーが台湾の特許を取得 PAT. M574100
- H.C.B 舉辦第二屆 H.C.B 全國國中籃球盃比賽
 H.C.B held the second "National Junior Hhigh School Basketball Competition".
 H.C.B が二回目の全国バスケットボールカップ競技会を開催しました。
- 我們即將建設二廠
 we have start to build H.C.B Second Factory
 H.C.B 第2工場が着工しています。
- 申請 H.C.B 商標美國專利
 Applied for H.C.B trademark logo in USA.
 H.C.B の商標米国特許を申請します。



Brand Story

台灣1990年代

在全球化的加速發展下，國際競爭力已成為工商企業存在與繁榮的關鍵因素。

In 1990's Taiwan.

Under the accelerated development of globalization, the international competitiveness of businesses has become a key in the existence and prosperity.

Taiwan in den 80ern

Unter der beschleunigten Entwicklung der Globalisierung hat sich die internationale Wettbewerbsfähigkeit der Unternehmen zu einem Schlüssel zu Existenz und Wohlstand entwickelt.

由於面臨國內產業外移腳步加快，大廠外移的處境，原本創立於1990/05/01以接單製造機械零件加工之業務為主的鉅祥公司面臨到了訂單縮減的重大問題，但危機未嘗不是轉機？

Faced with the acceleration of the domestic industry relocation, Gu Siang Tools Develop Co., Ltd., founded in 1990/05/01 and doing the manufacture of mechanical parts processing, faced with losing orders. But a crisis is also a turning point, isn't it?

Mit Blick auf die heimische Industrie um den Standort voran zu bringen, wurde Gu Siang Tools Co. Ltd. zur Herstellung und Verarbeitung mechanischer Teile am 05.01.1990 gegründet, trotz verringerter Bestellungen. Aber ist eine Krise nicht auch ein Wendepunkt?

契機來的突然，黃盛彬先生某日接獲友人來電說道：「友人因苦惱修車時遇到無法將零件拆卸更換的問題，所以希望黃盛彬先生可以幫忙解決。」黃盛彬先生熱心助人並馬上前往查看，苦思許久後製作出了修護工具並解決朋友的問題。

Opportunity came suddenly, Mr. Hwang Cherng Bin received a call for help one day. It was from a friend who was distressed about how to disassemble and replace parts of the car. Mr. Hwang went and checked. After thinking for a while, Mr. Hwang came up with an idea that he could produce repair tools to solve the problem. And finally Mr. Hwang solved the friend's problem.

Die Gelegenheit kam plötzlich als Mr. Hwang Cherng Bin eines Tages einen Hilferuf eines Freundes bekam, der verzweifelt war wie man Teile auseinander baut und sie ersetzt. Mr. Hwang ging, prüfte und kam nach langer Zeit wieder um ein Reparaturwerkzeug zur Problemlösung herzustellen.

友人感謝之餘，希望向黃盛彬先生購買此修護工具，黃盛彬先生才恍然大悟或許這是可以解決公司面臨訂單縮減的契機，非常感念友人給予的契機。

This friend thanked and would like to purchase this repair tool. Mr. Hwang suddenly realized this can save the company from facing reduction of orders. Until now, Mr. Hwang has an immense gratitude to this friend for the opportunity he gave.

Dieser Freund bedankte sich und wollte gerne das Reparaturwerkzeug kaufen. Mr. Hwang dämmerte, dass das der Firma helfen kann um den verringerten Bestellungen entgegenzuwirken. Bis heute ist Herr Hwang diesem Freund für diese Möglichkeit sehr dankbar.

鉅祥公司致力於汽車修護工具之製造加工，品質長期受業界肯定，於西元2000年自創H. C. B AUTO TOOLS品牌，並以開發BENZ及BMW汽車特殊修護工具為主要目標，提高產品附加價值，另一方面持續開發卡車特殊修護工具、引擎、底盤、輪胎定位、鈹金修護工具，品質優良，造福保養汽車同業，頗受好評。

此外，鉅祥公司也是台灣唯一的卡車工具研發廠商並且榮獲了政府補助。

After that, Company has been concentrating on the production for a wide range of Auto Maintenance Tools and thus built up OBM-H.C.B SPECIALTY TOOLS. H.C.B regards the design and development of BENZ & BMW repair tools as primary object to increase the value of products. On the other hand, company continues to develop special truck repair tools for engines, chassis and tire position. As a result of our high quality products and outstanding customer service, H.C.B has gained a global sales network reaching all over the world. Not only well appreciated by purchasers, but also HCB accesses government subsidies because HCB is the only truck repairing tool manufacturer in Taiwan.

Seitdem ist die Firma mit der Produktion eines weiten Spektrums von Kfz-Wartungswerkzeugen beschäftigt und gründete OBM-H.C.B SPEZIALWERKZEUGE.

H.C.B. ist mit dem Design und der Entwicklung von Kfz-Reparaturwerkzeugen für BENZ & BMW beschäftigt.

Auf der anderen Seite setzt das Unternehmen die Entwicklung spezieller Reparaturwerkzeuge für LKW, Motoren, Karosserie und Fahrwerk fort. Als Ergebnis unserer hohen Produktqualität und unseres Kundenservice, hat H.C.B. ein globales Vertriebsnetzwerk erreicht. Nicht nur von seinen Kunden geschätzt, sondern auch der einzige Hersteller von LKW Reparaturwerkzeugen mit Zugang zu staatlichen Subventionen.





SINCE 1990

HWANG CHERNG BIN
Specialty Tools Inc.

Photos inside our production facilities

SINCE 1990

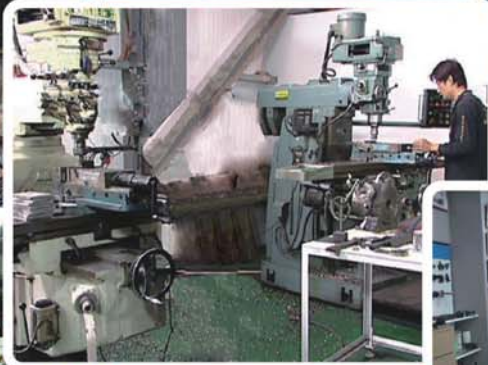



HWANG CHERNG BIN
Specialty Tools Inc.





HWANG CHERNG BIN
Specialty Tools Inc.

PATENT CERTIFICATE

Global Patent
Certification





HWANG CHERNG BIN Specialty Tools Inc.

TRUCK FLYWHEEL TOOLS



H.C.B-A1797 IVECO DUAL GEAR ENGINE FLYWHEEL ROTATOR (WITH 2 GEARS)

- Designed for dual gear engine flywheel rotation for timing.
- Suitable for Euro Cargo/ Cargo Eurotech/ Heavyon/ Off Road/ Bus models.
- Engine models:
8040-25-45/
8060-25-45/
8460/ 8260/
8280/ 8210.42/
190.38/ 190.42



H.C.B-A1618 IVECO DUAL GEAR ENGINE FLYWHEEL ROTATOR (WITH 2 GEARS)

- Designed for dual gear engine flywheel rotation for timing.
- Application: Euro Cargo / Cargo 150E27R PR / FPR 320E27T / PT Eurotech / Eurostar models



H.C.B-A1634 RENAULT MAGNUM TRUCK ENGINE FLYWHEEL ROTATOR (Dr. 1/2")

- Tool for engine flywheel rotation during the tappets adjustment.
- Application:
RENAULT MAGNUM



H.C.B-A1227 SCANIA TRUCK CRANK FLYWHEEL ROTATOR (Dr. 1/2")

- This tool is designed to rotating crankshaft for timing.
- Application:
SCANIA Truck after 1996



H.C.B-A1492 BENZ & MAN FLYWHEEL ROTATING TOOL (WITH 2 GEARS) (Dr. 1/2")

- Application :
Used on Mercedes trucks models 400 e.g. engines OM 401, 402, 403, 407, ACTROS, as well as for all MAN 12-cylinder engines.



H.C.B-A1493 BENZ & MAN FLYWHEEL ROTATING TOOL (WITH 3 GEARS) (Dr. 1/2")

- Application :
Used on Mercedes trucks models 900 e.g. engines 904 and 906 ACTROS and ATEGO, also for all MAN engines. (Not for 12-cylinder engines.)



H.C.B-A1494 MAN FLYWHEEL ROTATING TOOL (WITH 1 GEAR) (Dr. 1/2")

- Flywheel rotating tool with 1 gear wheels.
- Application :
MAN engines D20/ D25 /D26 /D28



H.C.B-A1175 VOLVO (MP7) FLYWHEEL TURNING TOOL

- This tool is designed to rotate crankshaft for timing.
- Application:
VOLVO (MP7)



H.C.B-A1244 DAF TRUCK FLYWHEEL ROTATOR (35 - 42 TONS)(EURO 3)

- This tool is designed for rotating crankshaft for timing.
- Application:
DAF (35 TONS-42TONS) (EURO 3) truck.



H.C.B-A1398 DAF TRUCK FLYWHEEL ROTATOR (35-42 TONS) (EURO 4)

- This tool is designed for rotating crankshaft for timing.
- Application:
DAF (35-42 TONS) (EURO 4) TRUCK



H.C.B-B1175 VOLVO (MP8/MP10) & RENAULT (370) FLYWHEEL TURNING TOOL

- This tool is designed to rotate crankshaft for timing.
- Application :
VOLVO truck (MP8 & MP10), (FH, D13A520)



H.C.B-C1175 VOLVO TRUCK FLYWHEEL ROTATING TOOL

- Gear for rotating engine flywheel during the timing search.
- Application:
VOLVO



歐系卡車修護工具
European Truck Repair Tool

H.C.B-B1050-1	P002	H.C.B-B1126	P006
SCANIA FRONT WHEEL SHOCK ABSORBER SPRING WASHER SOCKET (Dr. 3/4") SCANIA前輪避震器彈簧墊片拆裝套筒 (Dr. 3/4")		SCANIA REAR WHEEL NUT SOCKET (Dr. 3/4", 8 POINTS, 100mm) SCANIA後輪螺帽拆裝套筒(Dr. 3/4" · 8角 · 100mm)	
H.C.B-B1050-5	P002	H.C.B-C1126	P006
SCANIA REAR AXLES DAMPER ROD SOCKET (Dr. 3/4") SCANIA後輪避震器彈簧墊片拆裝套筒 (Dr. 3/4")		SCANIA REAR WHEEL SOCKET (Dr. 1", 8 POINTS, 100mm) SCANIA後輪螺帽拆裝套筒(Dr. 1" · 8角 · 100mm)	
H.C.B-B1050-7	P002	H.C.B-A1167	P006
SCANIA REAR WHEEL SHOCK ABSORBER SPRING WASHER SOCKET (Dr. 3/4") SCANIA後輪避震器彈簧墊片拆裝套筒 (Dr. 3/4")		SCANIA, BENZ (W203 / W209) WRENCH SOCKET (FLUID RESERVOIR ON CONDENSER) (Dr. 1/2", 27mm) SCANIA, BENZ (W203 / W209) 冷凝器貯油槽套筒扳手 (Dr. 1/2", 27mm)	
H.C.B-A1050-8	P002	H.C.B-A1227	P006
SCANIA 10 WHEELS CAB THIRD AXLE NUT SOCKET (Dr. 3/4", 8 POINTS, 95mm) SCANIA 10輪拖車頭第三軸螺帽套筒 (Dr. 3/4" · 8角 · 95mm)		SCANIA TRUCK CRANK FLYWHEEL ROTATOR (Dr. 1/2") SCANIA卡車曲軸飛輪轉動器(Dr. 1/2")	
H.C.B-A1090	P002	H.C.B-A1236	P007
SCANIA TRUCK (310/320/340) TRANSMISSION SOCKET (Dr. 3/4") SCANIA卡車(310/320/340)變速箱專用套筒 (Dr. 3/4")		SCANIA (320/340/360) KING PIN EXTRACTOR (10 WHEELS) SCANIA (320/340/360)大王銷拆卸器(10輪)	
H.C.B-B1090	P003	H.C.B-A1257	P007
SCANIA TRANSMISSION CLUTCH FRONT MAIN SHAFT SOCKET (Dr. 3/4") SCANIA變速箱離合器前主軸螺帽套筒 (Dr. 3/4")		SCANIA (340) ELECTROMAGNETIC INJECTION VALVE CAP SOCKET (Dr. 1/2", 8 POINTS, 38mm) SCANIA (340)電磁閥噴油嘴蓋套筒(Dr. 1/2", 8角, 38mm)	
H.C.B-C1090	P003	H.C.B-A1278	P007
SCANIA 8-SPEED BUS TRANSMISSION NUT SOCKET (Dr. 3/4") SCANIA變速箱螺帽拆裝套筒 (遊覽車8速) (Dr. 3/4")		SCANIA (420) AXLE HUB NUT SOCKET (Dr. 3/4", 8 TEETH) SCANIA (420)輪軸螺帽套筒(Dr. 3/4", 8齒)	
H.C.B-D1090	P003	H.C.B-A1265	P008
SCANIA TRANSMISSION CLUTCH FRONT MAIN AXLE NUT SOCKET (Dr. 3/4") SCANIA變速箱離合器前主軸螺帽套筒 (Dr. 3/4")		SCANIA (320/340) / VOLVO(FM12) PITMAN ARM PULLER (Dr. 3/4", 58mm) SCANIA (320/340) / VOLVO(FM12)方向機搖臂拆卸器 (Dr. 3/4", 58mm)	
H.C.B-E1090	P003	H.C.B-B1265	P008
SCANIA PTO NUT SOCKET (Dr. 1/2") SCANIA卡車PTO螺帽拆裝套筒 (Dr. 1/2")		SCANIA (320/340) / VOLVO(FM12) PITMAN ARM PULLER (58mm) (W/HYDRAULIC) SCANIA (320/340) / VOLVO(FM12)方向機搖臂拆卸器 (58mm) (油壓式)	
H.C.B-F1090	P004	H.C.B-B1277	P008
SCANIA (340) TRANSMISSION CLUTCH FRONT MAIN SHAFT SOCKET (Dr.3/4") SCANIA (340) 變速箱離合器前主軸螺帽套筒 (Dr.3/4")		SCANIA (320/340) / VOLVO(FM12)/ MAN(FE414) STEERING MECHANISM BEARING PULLER SCANIA (320/340) / VOLVO(FM12)/ MAN(FE414)方向機培林拆卸組	
H.C.B-G1090	P004	H.C.B-A1284	P009
SCANIA DIFFERENTIAL REAR AXLE NUT SOCKET (Dr.3/4") SCANIA 差速器後輪軸螺母套筒 (Dr.3/4")		SCANIA TRANSMISSION REAR OIL SEAL INSTALLER SCANIA變速箱後油封安裝器	
H.C.B-B1091	P004	H.C.B-A1181	P009
SCANIA TRUCK FRONT WHEEL AXLES HUB EXTRACTOR SCANIA卡車前輪仰角HUB拆卸器		SCANIA & VOLVO SPRING PIN METAL BUSH REMOVAL / INSTALLATION KIT (W/HYDRAULIC) SCANIA & VOLVO卡車彈簧銷拆裝工具組(油壓式)	
H.C.B-C1091	P004	H.C.B-A1319	P009
SCANIA TRUCK FRONT WHEEL AXLES HUB EXTRACTOR (W/HYDRAULIC) SCANIA卡車前輪仰角HUB拆卸器 (油壓式)		SCANIA (310/320) CRANKSHAFT REAR OIL SEAL INSTALLER SCANIA (310/320)曲軸後油封安裝器	
H.C.B-A1125	P005	H.C.B-A1350	P010
SCANIA FRONT WHEEL NUT SOCKET (H41, 8 POINTS, 80mm) SCANIA前輪螺帽拆裝套筒 (H41 · 8角 · 80mm)		SCANIA RADIATOR ADAPTOR SCANIA水箱快速接頭	
H.C.B-B1125	P005	H.C.B-A1606	P010
SCANIA FRONT WHEEL NUT SOCKET (Dr. 3/4", 8 POINTS, 80mm) SCANIA前輪螺帽拆裝套筒 (Dr. 3/4" · 8角 · 80mm)		SCANIA 340/380 (EURO 4) CRANKSHAFT FRONT/REAR OIL SEAL INSTALLER (PR SERIES) SCANIA 340/380(4期環保車) 曲軸前後油封安裝工具組(PR系列)	
H.C.B-C1125	P005	H.C.B-B1606	P010
SCANIA FRONT WHEEL NUT SOCKET (Dr. 1", 8 POINTS, 80mm) SCANIA前輪螺帽拆裝套筒 (Dr. 1" · 8角 · 80mm)		SCANIA (114) 340/360/380 CRANKSHAFT FRONT OIL SEAL INSTALLER SCANIA(114) 340/360/380曲軸前油封安裝工具	
H.C.B-A1126	P005	H.C.B-C1606	P011
SCANIA REAR WHEEL NUT SOCKET (8 POINTS, 100mm) SCANIA後輪螺帽拆裝套筒(8角 · 100mm)		SCANIA (114) 340/ 360/ 380 CRANKSHAFT FRONT OIL SEAL INSTALLER (AFTER2010) SCANIA (114) 340/ 360/ 380 曲軸前油封安裝工具(2010以後)	

H.C.B-B1402	P011	H.C.B-B1050-2	P017
SCANIA (340/360/380) VALVE SPRING COMPRESSOR TOOL KIT SCANIA (340/360/380) 汽門彈簧壓縮工具組		BPW TRAILER REAR WHEEL SOCKET (6.5~9 TONS) (Dr.3/4", OVAL, 95mm) BPW 板車輪軸蓋拆裝套筒 (6.5~9 噸) (Dr.3/4", 橢圓, 95mm)	
H.C.B-A1630	P012	H.C.B-A1050-3	P017
SCANIA (114) INJECTOR REMOVAL/ INSTALLATION TOOL KIT SCANIA (114) 噴油嘴拆裝工具組		BPW TRAILER REAR WHEEL SOCKET (FORMER 16 TONS) (H41, 8 POINTS, 120mm) BPW 板車輪軸蓋拆裝套筒 (舊型16 噸)(H41,8角,120mm)	
H.C.B-A2228	P012	H.C.B-B1050-3	P017
SCANIA SOCKET (Dr. 3/4", 90mm) (E28) SCANIA 套筒(Dr. 3/4" · 90mm)(E28)		BPW TRAILER REAR WHEEL SOCKET (NEW 16 TONS) (Dr. 3/4" , 8 POINTS, 110mm) BPW 板車輪軸蓋拆裝套筒(新型16噸) (Dr. 3/4", 8角, 110mm)	
H.C.B-A1701	P012	H.C.B-A1050-4	P018
SCANIA TRUCK INJECTOR ADJUSTOR SCANIA 卡車噴油嘴調整器		BPW TRAILER REAR WHEEL SOCKET (12 TONS) (H41, 8 POINTS, 109mm) BPW 板車輪軸蓋拆裝套筒(12噸) (H41, 8角, 109mm)	
H.C.B-A1730	P012	H.C.B-A1050-6	P018
SCANIA 114 (340/ 360/ 380) TRUCK PISTON RING INSTALLATION SLEEVE SCANIA 114 (340/ 360/ 380) 卡車活塞安裝工具		BPW TRAILER REAR WHEEL SOCKET (12 TONS) (Dr. 1" , OVAL, 111mm) BPW 板車輪軸蓋拆裝套筒(12噸) (Dr. 1", 橢圓, 111mm)	
H.C.B-C1353	P013	H.C.B-B1050-6	P018
New KNORR-BREMSE DISC BRAKE SERVICE KIT 卡車碟煞(KNORR-BREMSE)維修組		BPW TRAILER REAR WHEEL SOCKET (12 TONS) (Dr. 1" , OVAL, 108mm) BPW 板車輪軸蓋拆裝套筒(12噸) (Dr. 1", 橢圓, 108mm)	
H.C.B-A1353	P013	H.C.B-C1050-6	P018
KNORR-BREMSE DISC BRAKE SERVICE KIT 卡車碟煞(KNORR-BREMSE)維修組		BPW TRAILER REAR WHEEL SOCKET (13~14 TONS) (Dr. 1" , OVAL, 120mm) BPW 板車輪軸蓋拆裝套筒(13~14噸) (Dr. 1", 橢圓, 120mm)	
H.C.B-B1353	P013	H.C.B-D1050-6	P019
CALLIPER ADJUSTER SOCKET (H24, 5 TEETH) 卡鉗調整器套筒(H24, 5齒)		BPW TRAILER REAR WHEEL SOCKET (Dr.1",109mm) BPW板車輪軸蓋拆裝套筒 (Dr.1",109mm)	
H.C.B-A1444	P014	H.C.B-A1066-3-1	P019
SCANIA TRUCK REAR WHEEL AXLES HUB REMOVER (ALL MODELS) SCANIA 卡車帶動軸輪殼拆卸工具 (全車系)		BPW 12 TONS AXLE EXTRACTOR (M135 x P2.0) BPW 12噸輪軸拔取器 (M135 x P2.0 · 內牙)	
H.C.B-A1281	P014	H.C.B-A1066-3-2	P019
BPW 16 TONS ROLLER AXLE NUT SOCKET (Dr. 3/4", 6POINTS, 85mm) BPW 16噸輪軸螺母套筒(Dr. 3/4", 6角, 85mm)		BPW 12 TONS AXLE EXTRACTOR (M136 x P2.5) BPW 12噸輪軸拔取器 (M136 x P2.5 · 內牙)	
H.C.B-A2193	P014	H.C.B-A1066-2	P019
DIESEL INJECTOR PULLER 柴油噴油嘴拆卸器		BPW 16 TONS AXLE EXTRACTOR (M155 x P3.0) BPW 16噸輪軸拔取器 (M155 x P3.0 · 外牙)	
H.C.B-A1490	P015	H.C.B-A1066-1	P020
SCANIA 113 (10 SPEED) TRANSMISSION MAINSHAFT/ COUNTERSHAFT/ INPUT SHAFT BEARING PULLER SCANIA 113 (10速) 變速箱主軸/ 副軸/ 輸入軸 培林拆卸工具		BPW 12 TONS AXLE EXTRACTOR (M125 x P2.0) BPW 12噸輪軸拔取器(M125 x P2.0 · 外牙)	
H.C.B-B1490	P015	H.C.B-A1171	P020
SCANIA 113 (10 SPEED) TRANSMISSION MAINSHAFT/ COUNTERSHAFT/ INPUT SHAFT BEARING INSTALLER SCANIA 113 (10速) 變速箱主軸/ 副軸/ 輸入軸 培林安裝工具		BPW 12 TONS ROLLER AXLE NUT SOCKET (Dr. 3/4") BPW 12噸板車輪軸螺母套筒(Dr. 3/4")	
H.C.B-C1490	P015	H.C.B-B1171	P020
SCANIA 113 (10 SPEED) TRANSMISSION MAINSHAFT/ COUNTERSHAFT/ INPUT SHAFT BEARING REMOVAL/ INSTALLATION TOOL SCANIA 113 (10速) 變速箱主軸/ 副軸/ 輸入軸 培林拆裝工具		BPW 6.5 ~ 9 TONS ROLLER AXLE NUT SOCKET (Dr. 3/4") BPW 6.5~9噸板車輪軸螺母套筒(Dr. 3/4")	
H.C.B-A1478	P016	H.C.B-C1171	P021
SCANIA 310(112) & 320(113) EXTRACTOR SCANIA 310(112) & 320(113)傳動軸接座&曲軸油封接座拆卸器		BPW 13~14 TONS ROLLER AXLE NUT SOCKET (Dr. 3/4") BPW 13~14噸板車輪軸螺母套筒(Dr. 3/4")	
H.C.B-D1391	P016	H.C.B-A1071	P021
SCANIA REAR WHEEL HUB INNER BEARING EXTRACTOR SCANIA 後輪軸內側培林拆卸器		MAN(422/403), BENZ TRUCK DIESEL INJECTION VALVE SOCKET MAN (422/403), BENZ卡車柴油噴油嘴專用套筒	
H.C.B-E1391	P016	H.C.B-A1075	P021
SCANIA REAR WHEEL HUB INNER BEARING INSTALLER SCANIA 後輪軸內側培林安裝器		MAN FRONT WHEEL HUB EXTRACTOR MAN卡車前輪HUB拆卸器	
H.C.B-A1050-2	P017	H.C.B-A1228	P021
BPW TRAILER REAR WHEEL SOCKET (12 TONS)(H41,OVAL,111mm) BPW 板車輪軸蓋拆裝套筒 (12 噸)(H41,橢圓,111mm)		MAN TRUCK TRANSMISSION SOCKET (Dr. 3/4") MAN卡車變速箱專用套筒(Dr. 3/4")	

H.C.B-B1075 P022 MAN FRONT WHEEL HUB INSTALLER MAN卡車前輪HUB安裝器	H.C.B-A2018-19 P028 MAN TRUCK OIL FILTER WRENCH (Dr. 1/2", 18 POINTS, 135mm) MAN 卡車機油芯扳手 (Dr. 1/2", 18角, 135mm)
H.C.B-A1172 P022 MAN AXLE BEARING EXTRACTOR MAN卡車輪軸培林拔卸器	H.C.B-A1176 P028 VOLVO WHEEL SHAFT COVER SOCKET (Dr. 3/4", 8 POINTS, 115mm) VOLVO卡車輪軸蓋套筒(Dr. 3/4", 8角, 115mm)
H.C.B-B1172 P022 MAN TRACTOR (33460/410/414) AXLE BEARING EXTRACTOR MAN卡車前輪(33460/410/414)輪軸培林拆卸器	H.C.B-B1175 P028 VOLVO (MP8/MP10) & RENAULT (370) FLYWHEEL TURNING TOOL VOLVO (MP8/MP10)& RENAULT (370) 曲軸飛輪轉動工具
H.C.B-A1203 P023 MAN TRUCK DIFFERENTIAL BEARING EXTRACTOR MAN卡車差速器培林拔卸器	H.C.B-C1175 P029 VOLVO TRUCK FLYWHEEL ROTATING TOOL VOLVO 卡車飛輪轉動工具
H.C.B-A1273 P023 MAN (FE410A/FE414) PITMAN ARM PULLER (Dr. 3/4", 67mm) MAN (FE410A/FE414)卡車方向機搖臂拆卸器(Dr. 3/4", 67 mm)	H.C.B-A1910 P029 VOLVO/ MACK LEAF SPRING PIN SOCKET VOLVO/ MACK 彈簧插銷套筒
H.C.B-A1274 P023 MAN (FE410A) STEERING MECHANISM OIL SEAL SOCKET (Dr. 1/2", 4 POINTS) MAN (FE410A)卡車方向機油封套筒(Dr. 1/2", 4點)	H.C.B-A1175 P029 VOLVO (MP7) FLYWHEEL TURNING TOOL VOLVO (MP7)卡車曲軸飛輪轉動器
H.C.B-B1239 P024 MAN FRONT WHEEL HUB REMOVER (20 TONS HYDRAULIC) MAN前輪輪殼拔卸器 (20噸油壓缸)	H.C.B-A1186 P029 VOLVO SHOCK ABSORBER SPRING WASHER REMOVAL SOCKET (H27) (FRONT) VOLVO避震器彈簧墊片拆卸套筒(H27)(前)
H.C.B-A1239 P024 MAN TRUCK FRONT WHEEL HUB REMOVER MAN卡車前輪HUB拔卸器	H.C.B-B1186 P030 VOLVO SHOCK ABSORBER SPRING WASHER REMOVAL SOCKET (Dr. 3/4") (REAR) VOLVO避震器彈簧墊片拆卸套筒(Dr. 3/4")(後)
H.C.B-A1328 P024 MAN TGA FRONT WHEEL AXLE NUT SOCKET (Dr.3/4", H60, 93mm) MAN TGA卡車前輪軸&後輪舉升軸螺帽套筒(Dr. 3/4", H60, 93mm)	H.C.B-A1229 P030 VOLVO (FM12) TRANSMISSION CLUTCH CALIPER PISTONS DEPTH LEVEL GAUGE VOLVO (FM12)卡車變速箱離合器分泵深度量規
H.C.B-A1329 P024 MAN TGA DRIVE AXLE NUT SOCKET (Dr. 3/4", H60, 158mm) MAN TGA卡車帶動軸螺帽套筒(Dr. 3/4", H60, 158mm)	H.C.B-A1238 P030 VOLVO TRUCK AXLE NUT SOCKET (Dr. 3/4", 6 POINTS, 105mm) VOLVO卡車輪軸螺帽套筒(Dr. 3/4", 6角, 105mm)
H.C.B-B1329 P025 MAN TGA DRIVE AXLE NUT SOCKET (Dr. 3/4") MAN TGA卡車帶動軸螺帽套筒 (Dr. 3/4")	H.C.B-B1238 P030 VOLVO TRUCK AXLE NUT SOCKET (Dr. 3/4", 6 POINTS, 95mm) VOLVO卡車輪軸螺帽套筒(Dr. 3/4", 6角, 95mm)
H.C.B-A1344 P025 MAN, BENZ DIFFERENTIAL REAR NUT SOCKET(Dr. 3/4", 6 TEETH) MAN, BENZ 卡車差速器後螺母套筒(Dr. 3/4", 6齒)	H.C.B-A1246 P031 VOLVO TRUCK CAB SHOCK ABSORBER UPPER BASE NUT EXTRACTOR / INSTALLER VOLVO卡車車頭避震器上座螺帽拆裝器
H.C.B-A1345 P025 MAN, BENZ DRIVE AXLE NUT SOCKET(Dr. 3/4", H60, 6 TEETH) MAN, BENZ 卡車帶動軸螺帽套筒(Dr. 3/4", H60, 6齒)	H.C.B-A1247 P031 VOLVO TRUCK OIL FILTER WRENCH (Dr. 1/2", 15POINTS, 107mm) VOLVO卡車機油芯扳手(Dr. 1/2", 15角, 107mm)
H.C.B-A2132 P026 MAN STAR-E IMPACT SOCKET (Dr. 3/4", E18/E20) (FOR HGV CYLINDER-HEAD BOLT) MAN卡車星型衝擊式套筒(Dr. 3/4", E18/E20)(氣缸床用)	H.C.B-A1269 P031 SCANIA /VOLVO TRUCK CAB REMOVAL WRENCH (12 POINTS, 22mm) SCANIA /VOLVO 拖車頭拆卸扳手(12角, 22mm)
H.C.B-B2132 P026 MAN STAR-E IMPACT SOCKET KIT (FOR HGV CYLINDER-HEAD BOLT) MAN卡車星型衝擊式套筒(氣缸床用)	H.C.B-A1335 P032 VOLVO (FM12) KING PIN UPPER COVER SOCKET (Dr. 3/4", 6 POINTS, 80mm) VOLVO (FM12)卡車大王銷上蓋套筒 (Dr. 3/4", 6角, 80mm)
H.C.B-C2132 P026 MAN STAR-E IMPACT SOCKET KIT (FOR HGV CYLINDER-HEAD BOLT)(6 PCS) (E18/E20/E22/E24/17 mm/19 mm)(6 POINT) MAN卡車星型衝擊式套筒組(氣缸床用)(6 PCS) (E18/E20/E22/E24/17mm/19mm)(6角)	H.C.B-B1350 P032 VOLVO RADIATOR ADAPTOR VOLVO卡車水箱快速接頭
H.C.B-A1169 P027 VOLVO TRUCK FRONT/REAR BRAKE SHOE LINING INSIDE CALIPER VOLVO卡車前後輪煞車來令片更換卡鉗夾	H.C.B-B1350-H P032 COOLANT DRAIN HOSE VOLVO卡車水箱快速接頭與管
H.C.B-B1102 P027 EUROPEAN TRUCK BALL JOINT REMOVER (39mm) PAT. M 362085 歐系卡車球接頭拔卸器(39mm)	H.C.B-A1363 P032 VOLVO TRUCK KING PIN BEARING PULLER VOLVO卡車大王銷培林拔卸器
	H.C.B-A1380 P033 VOLVO TRUCK FAN BEARING BASE SOCKET (Dr. 1/2") VOLVO卡車風扇軸承底座套筒 (Dr. 1/2")

H.C.B-A1402 P033 VOLVO (FM) VALVE SPRING COMPRESSOR TOOL KIT VOLVO (FM) 汽門彈簧壓縮工具組	H.C.B-B1627 P039 VOLVO (FM) TRUCK FRONT WHEEL AXLE BEARING/ OIL SEAL INSTALLER VOLVO (FM) 卡車前輪軸培林/油封安裝工具
H.C.B-A2018-3 P033 VOLVO TRUCK OIL FILTER WRENCH (Dr. 1/2", 15 POINTS, 107mm) VOLVO 卡車機油芯扳手 (Dr. 1/2", 15角, 107mm)	H.C.B-C1627 P039 VOLVO (FM) TRUCK LIFTING AXLE BEARING/ OIL SEAL INSTALLER VOLVO (FM) 卡車舉升軸培林/油封安裝工具
H.C.B-A1695 P033 VOLVO DIFFERENTIAL FLANGE NUT SOCKETS (Dr. 1/2") VOLVO 傳動軸凸緣螺帽套筒 (Dr. 1/2")	H.C.B-A1646 P040 VOLVO (FM/FH) (12 SPEED) TRANSMISSION MAINSHAFT BEARING/ GEAR REMOVAL TOOL VOLVO (FM/FH) (12速)變速箱主軸培林/齒輪 拆卸工具
H.C.B-B1393 P034 VOLVO (FM) TRUCK INJECTOR SLEEVE REMOVER/INSTALLER SET VOLVO (FM) 噴油嘴銅套拆裝工具組	H.C.B-A1654 P040 VOLVO (FM) OUTPUT SHAFT SEAL INSTALLER VOLVO (FM) 變速箱後油封安裝工具
H.C.B-A1393 P034 VOLVO (FM12) TRUCK INJECTOR SLEEVE REMOVER / INSTALLER SET VOLVO (FM12) 噴油嘴銅套拆裝工具組	H.C.B-A1677 P040 VOLVO TRUCK VALVE SUPPORT HANGER VOLVO 卡車汽門支撐吊架
H.C.B-C1393 P035 VOLVO (FM/ FM12/ FH) TRUCK INJECTOR SLEEVE REMOVAL/ INSTALLATION TOOL KIT VOLVO (FM/ FM12/ FH) 卡車噴油嘴銅套拆裝工具組	H.C.B-A1693 P040 VOLVO TRUCK PISTON RING INSTALLATION SLEEVE VOLVO 卡車汽缸套活塞安裝器
H.C.B-A1462 P035 VOLVO (FM/ FH) INJECTOR NOZZLE PULLER VOLVO (FM/ FH) 噴油嘴拆卸工具	H.C.B-B1693 P041 VOLVO TRUCK PISTON RING INSTALLATION SLEEVE VOLVO 卡車汽缸套活塞安裝器
H.C.B-F1560 P036 VOLVO (FM12) (EV90/ EV91) TRUCK DIFFERENTIAL MAIN SHAFT BEARING EXTRACTOR VOLVO (FM12) (EV90/ EV91) 卡車差速器主軸培林拆卸器	H.C.B-C1693 P041 VOLVO TRUCK PISTON RING INSTALLATION SLEEVE VOLVO 卡車汽缸套活塞安裝器
H.C.B-H1560 P036 VOLVO (FM12) (EV90/ EV91) DIFFERENTIAL FRONT/ REAR MAINSHAFT BEARING REMOVAL/ INSTALLATION TOOL KIT VOLVO (FM12) (EV90/ EV91) 卡車差速器前/ 後主軸培林拆裝工具組	New H.C.B-D1693 P041 VOLVO (FM 500) (EURO 5) TRUCK PISTON RING INSTALLATION SLEEVE VOLVO (FM 500) (5期) 卡車汽缸套活塞安裝器
H.C.B-A1609 P036 VOLVO (FM/FH) MAIN SHAFT BEARING INSTALLER VOLVO (FM/FH) 差速器主軸培林安裝工具	H.C.B-A1697 P041 VOLVO FM12 (420/430/440) TRUCK TIMING GEAR SOCKET VOLVO FM12 (420/430/440) 卡車 正時驅動齒輪套筒
H.C.B-A1423 P037 VOLVO (FM12) HYDRAULIC LIFT CYLINDER REMOVAL/ INSTALLATION KIT VOLVO (FM12) 舉升液壓缸拆裝工具	H.C.B-A1698 P042 VOLVO FM12 (420/430/440) TRUCK CRANKSHAFT REAR OIL SEAL INSTALLATION TOOL VOLVO FM12 (420/430/440) 卡車曲軸後油封安裝工具
H.C.B-A1608 P037 VOLVO (FM12/ FM/ FH) STRAIGHT LINK BALL JOINT REMOVER VOLVO (FM12/ FM/ FH) 直拉桿球接頭拆卸工具	H.C.B-A1707 P042 VOLVO (FM, FH 500P/ 540P) TRUCK CABIN SHOCK ABSORBER SPRING COMPRESSOR DE.PAT. 20 2017 101 722 TW PAT. M542590 VOLVO (FM, FH 500P/ 540P) 卡車車廂避震器壓縮工具
H.C.B-A1614 P037 VOLVO (FM12/ FM) FRONT/REAR STABILIZER BALL JOINT REMOVER (43mm) VOLVO (FM12/ FM) 前後平衡軸吊桿球接頭拆卸工具 (43mm)	New H.C.B-B1320-052 P042 VOLVO TRUCK SOCKET (Dr. 1", 6 POINTS, 52 mm) VOLVO 卡車套筒 (Dr. 1", 6角, 52 mm)
H.C.B-A1615 P038 VOLVO (FM) TRUCK ABS SENSOR WHEEL FITTING TOOL VOLVO (FM) 卡車ABS齒環安裝工具	New H.C.B-B1675 P043 VOLVO (FH/FM/NH) TRUCK OIL SEAL REMOVAL SLIDE HAMMER VOLVO (FH/FM/NH) 卡車油封拆卸滑槌
H.C.B-A1616 P038 VOLVO TRUCK FITTING TIMING GEAR COVER INSTALLER VOLVO 卡車時規蓋安裝工具	New H.C.B-A1771 P043 VOLVO (FM12) TRUCK WHEEL AXLE FRONT/ REAR (INNER, OUTER) OIL SEAL INSTALLER VOLVO (FM12) 卡車輪軸前/後 (內/外) 油封安裝工具
H.C.B-A1617 P038 VOLVO TRUCK REMOVING AND FITTING TIMING GEAR PLATE TOOL VOLVO 卡車正時齒輪板工具	New H.C.B-A1800 P043 VOLVO TRUCK BEARING EXTRACTOR VOLVO 卡車培林拆卸器
H.C.B-A1626 P039 VOLVO (FM) TRUCK DISC BRAKE CALIPER FIXING SCREW WRENCH VOLVO (FM) 卡車碟煞卡鉗固定螺絲扳手	New H.C.B-A1799 P044 VOLVO TRUCK BEARING PULLER (18 TONS HYDRAULIC) VOLVO 卡車培林拆卸器 (18噸油壓缸)
H.C.B-A1627 P039 VOLVO (FM) TRUCK REAR WHEEL AXLE BEARING/ OIL SEAL INSTALLER VOLVO (FM) 卡車後輪軸培林/油封安裝工具	New H.C.B-A1801 P044 VOLVO TRUCK TRANSMISSION PTO REMOVER VOLVO 卡車變速箱PTO拆卸工具
	New H.C.B-A1802 P044 VOLVO TRUCK TRANSMISSION HIGH/ LOW GEAR ENGAGE TOOL VOLVO 卡車變速箱高低檔齒合板工具

New H.C.B-A1803 P045	New H.C.B-A1838 P050
VOLVO TRUCK BEARING PRESS VOLVO卡車培林安裝工具	VOLVO (FM 440/ 500/ FH 540) TRUCK AUTOMATIC TRANSMISSION REAR MAIN SHAFT GEAR REMOVER VOLVO (FM 440/ 500/ FH 540)卡車自排變速箱後主軸齒盤拆卸工具
New H.C.B-A1804 P045	H.C.B-A1454 P050
VOLVO TRUCK LIFTING EYE TOOL VOLVO卡車吊耳	DAF CF85 43 TONS TRAILER DRIVE SHAFT SOCKET (EURO 4 & EURO 5) (Dr. 3/4") DAF CF85 43 噸拖車頭傳動軸套筒 (四期、五期環保車) (Dr.3/4")
New H.C.B-A1805 P045	H.C.B-A1521 P051
VOLVO TRUCK ENGINE HOUSING SEPARATOR VOLVO卡車引擎蓋分離器	DAF (LF) 12/17 TONS OIL FILTER WRENCH (EURO 4/5)(Dr. 1/2",10 FLUTES,92mm) DAF (LF) 12/17 噸 (4/5期)機油芯扳手(Dr. 1/2",10 角,92mm)
New H.C.B-A1806 P045	H.C.B-A1190 P051
VOLVO TRUCK MAIN SHAFT/ COUNTER SHAFT REMOVAL/ INSTALLATION TOOL VOLVO 卡車主/副軸拆裝工具	DAF STEERING LINKAGE FIXING BASE SOCKET (Dr.1/2") DAF卡車方向機連桿固定座拆裝套筒(Dr. 1/2")
New H.C.B-A1807 P046	H.C.B-B1663 P051
VOLVO TRUCK AUTOMATIC TRANSMISSION (MAIN SHAFT/ COUNTER SHAFT) HIGH/ LOW GEAR ENGAGE TOOL VOLVO卡車自排變速箱(主軸/副軸)高低檔齒合板工具	DAF (CF) TRUCK 35 TONS DIFFERENTIAL MAINSHAFT BEARING REMOVAL/ INSTALLATION TOOL KIT DAF (CF)卡車35噸差速器主軸培林拆裝工具組
New H.C.B-A1808 P046	H.C.B-C1663 P052
VOLVO TRUCK BEARING INSTALLER VOLVO卡車培林安裝工具	DAF (CF) TRUCK 35 TONS DIFFERENTIAL FRONT/ REAR, MAINSHAFT BEARING REMOVAL/ INSTALLATION TOOL KIT DAF (CF)卡車35噸差速器前/後,主軸培林拆裝工具組
New H.C.B-A1810 P046	H.C.B-A1663 P053
VOLVO TRUCK THERMOSTAT SEAL INSTALLER VOLVO卡車節溫器油封安裝工具	DAF (CF) TRUCK 35 TONS DIFFERENTIAL FRONT/ REAR BEARINGS REMOVAL/ INSTALLATION TOOL DAF (CF)卡車35噸差速器前後培林拆裝工具組
New H.C.B-A1823 P047	H.C.B-B1465 P053
BENZ ACTROS TRUCK CABIN SHOCK ABSORBER SPRING COMPRESSOR BENZ ACTROS 卡車車屋避震器彈簧壓縮工具	DAF PISTON RING INSTALLATION SLEEVE (460P) (EURO 4/5) DAF 汽缸套活塞安裝器 (460P) (4/5期)
New H.C.B-A1824 P047	H.C.B-A1465 P053
VOLVO (FM 500) EURO 5 TRUCK BRAKE SHOES INSTALLATION TOOL VOLVO (FM 500) 5期卡車煞車片安裝工具	DAF PISTON RING INSTALLATION SLEEVE DAF 汽缸套活塞安裝器
New H.C.B-A1825 P047	H.C.B-A1244 P054
VOLVO (FM) TRUCK INPUT SHAFT BEARING INSTALLER VOLVO (FM)卡車輸入軸培林安裝工具	DAF TRUCK FLYWHEEL ROTATOR (35-42TONS) (EURO 3) DAF 卡車曲軸飛輪轉動器 (35-42噸) (三期環保)
New H.C.B-A1826 P047	H.C.B-A1716 P054
VOLVO (FM) TRUCK GEAR FIXING SCREW VOLVO (FM)卡車齒輪固定螺絲	ZF TRANSMISSION LOCATING PINS PULLER ZF變速箱固定銷拉拔器
New H.C.B-A1827 P048	H.C.B-A1398 P054
VOLVO (FM) TRUCK REAR AXLE BEARING INSTALLER VOLVO (FM)卡車後輪軸培林安裝工具	DAF TRUCK FLYWHEEL ROTATOR (35-42 TONS) (EURO 4) DAF 卡車曲軸飛輪轉動器(35-42噸) (四期環保)
New H.C.B-A1828 P048	H.C.B-A1271 P055
VOLVO (FM) TRUCK MAIN SHAFT BEARING REMOVER (18 TONS HYDRAULIC) VOLVO (FM)卡車主軸培林拆卸工具 (18噸油壓缸)	DAF TRUCK TRANSMISSION ASSEMBLY REMOVAL/ INSTALLATION TOOL KIT (ZF 16S) DAF卡車變速箱拆裝吊具(ZF 16速)
New H.C.B-A1829 P048	H.C.B-A1271-A P055
VOLVO INPUT SHAFT BEARING REMOVAL VOLVO輸入軸軸承拆卸工具	DAF TRUCK TRANSMISSION ASSEMBLY REMOVAL/ INSTALLATION SLING (ZF16S) DAF卡車變速箱拆裝吊具(ZF 16速)
New H.C.B-A1830 P049	H.C.B-A1271-B P055
VOLVO (FM) TRUCK MAIN SHAFT BEARING INSTALLER VOLVO (FM)卡車主軸培林安裝工具	DAF TRUCK TRANSMISSION MAIN SHAFT AND COUNTER SHAFT FIXED SEAT (ZF16S) DAF卡車變速箱主副軸固定座(ZF 16速)
New H.C.B-A1831 P049	H.C.B-A1271-C P055
VOLVO (FM) TRUCK INPUT SHAFT BEARING REMOVER VOLVO (FM)卡車輸入軸培林拆卸工具	DAF TRUCK PLANETARY GEAR GROUP SUPPORTING PLATE (ZF 16S) DAF卡車變速行星齒輪總成吊具(ZF 16速)
New H.C.B-A1833 P049	H.C.B-A1271-D P055
VOLVO (FM) TRUCK INPUT SHAFT BEARING REMOVER VOLVO (FM)卡車輸入軸培林拆卸座	DAF TRUCK TRANSMISSION PLANETARY GEAR ASSEMBLY SLING (ZF16S) DAF卡車變速箱行星齒輪總成吊具(ZF 16速)
New H.C.B-B1838 P050	
VOLVO (FM 440/ 500/ FH 540) TRUCK AUTOMATIC TRANSMISSION REAR MAIN SHAFT GEAR REMOVER(18 TONS HYDRAULIC) VOLVO (FM 440/ 500/ FH 540)卡車自排變速箱後主軸齒盤拆卸工具(18噸油壓)	

H.C.B-A1271-E P055 DAF TRUCK TRANSMISSION PLANETARY GEAR RETAINING BOLT (ZF16 S) DAF卡車變速箱主軸撥叉螺栓(ZF 16速)	H.C.B-A1685 P061 DAF (CF) (17/ 35/ 43TONS) DRIVE SHAFT BEARING INSTALLER DAF (CF) (17/ 35/ 43噸)帶動軸培林安裝工具
H.C.B-A1271-F P055 DAF TRUCK TRANSMISSION MAIN SHAFT BEARING INSTALLER (ZF16S) DAF卡車變速箱主軸培林安裝器(ZF 16速)	H.C.B-B1685 P061 DAF (CF) 26 TONS FRONT AXLE BEARING INSTALLER DAF (CF) 26噸前輪軸培林安裝工具
H.C.B-A1271-G P055 DAF TRUCK TRANSMISSION MAIN SHAFT BEARING INSTALLER (ZF16S) DAF卡車變速箱主軸培林安裝器(ZF 16速)	H.C.B-C1685 P061 DAF (CF) (17/ 35/ 43 TONS) FRONT AXLE / LIFT AXLE BEARING INSTALLER DAF (CF) (17/ 35/ 43噸)前輪軸/舉升軸培林安裝工具
H.C.B-A1271-H P055 DAF TRUCK TRANSMISSION MAIN SHAFT BEARING INSTALLER (ZF16S) DAF卡車變速箱主軸培林安裝器(ZF 16速)	H.C.B-C1402 P062 DAF (CF85) VALVE SPRING COMPRESSOR TOOL KIT (EURO 4/5) DAF (CF85)汽門彈簧壓縮工具組(4/5期)
H.C.B-B1271 P056 TRUCK TRANSMISSION /BEARING/ SHAFT SLEEVE / GEAR PULLER SET (ZF16S) 卡車變速箱/培林/軸套/齒輪拆卸工具組(ZF 16速)	H.C.B-A1562 P062 DAF(CF 85) COMPRESSOR REAR SEAT BEARING FIX BOLT SOCKET (11 RIBS) DAF(CF 85) 空壓機後座培林固定螺絲套筒(11齒)
H.C.B-C1271 P056 TRUCK TRANSMISSION /BEARING/ SHAFT SLEEVE / GEAR PULLER KIT (ZF16S221-16S251) 卡車變速箱/培林/軸套/齒輪拆卸工具組(ZF16S221-16S251)	H.C.B-A1753 P062 DAF 12 TONS (LF 45) FRONT AXLE NUT SOCKET (Dr.1") DAF 12噸 (LF45) 前輪軸螺帽套筒 (Dr.1")
H.C.B-A1432 P057 DAF TRANSMISSION NEUTRAL POSITION ADJUSTMENT TOOL DAF 變速箱空檔位置校正器	H.C.B-A1242 P063 BENZ ACTROS PITMAN ARM PULLER (Dr. 3/4", 42mm) BENZ ACTROS卡車方向機搖臂拆卸器(Dr. 3/4", 42mm)
H.C.B-A1718 P057 ZF STEP ENTRANCE BUS HUB REMOVAL/ INSTALLATION TOOL KIT ZF 低底盤巴士輪軸拆裝工具組	H.C.B-A1263 P063 TRUCK POSITION SENSOR SOCKET (Dr. 1/2", 8 POINTS, 27mm) 卡車位置感應器套筒(Dr. 1/2", 8角, 27mm)
H.C.B-A1572 P057 DAF (CF)DRIVE AXLE NUT SOCKET (EURO 5)(Dr. 1", 6 POINTS, 120 mm) DAF (CF)5期環保帶動軸螺帽套筒(Dr. 1", 6角, 120 mm)	H.C.B-A1314 P063 BENZ & MAN TRUCK FRONT AXLE NUT SOCKET (Dr. 3/4", SW 60mm, 76mm) BENZ & MAN 卡車前輪軸螺帽套筒 (Dr. 3/4", SW 60mm, 76mm)
H.C.B-A1602 P058 DAF TRUCK DIFFERENTIAL V TORSION BAR BUSH REMOVAL / INSTALLATION TOOL KIT (70mm) DAF 卡車差速器V型扭力桿鑷套拆裝工具組(70mm)	H.C.B-B1314 P064 BENZ & MAN TRUCK FRONT AXLE NUT SOCKET (Dr. 3/4", SW 56mm, 71mm) BENZ & MAN卡車前輪軸螺帽套筒 (Dr. 3/4", SW 56mm, 71mm)
H.C.B-B1602 P058 DAF TRUCK DIFFERENTIAL V TORSION BAR BUSH REMOVAL / INSTALLATION TOOL KIT(75mm) DAF 卡車差速器V型扭力桿鑷套拆裝工具組(75mm)	H.C.B-A1384 P064 BENZ TRUCK TRANSMISSION OIL LEVEL GAUGE BENZ卡車變速箱機油尺
H.C.B-A1409 P059 DAF XLR (EURO 4) PROPELLER SHAFT CENTER BEARING NUT SOCKET DAF 四期 XLR 傳動軸中間軸承固定套筒	H.C.B-A1832 P064 BENZ (2845/ 2846/ 2858) TRUCK AUTOMATIC TRANSMISSION ADJUSTER BENZ (2845/ 2846/ 2858)自排變速箱調整器工具
H.C.B-A1636 P059 DAF(CF 85)CRANKSHAFT FRONT OIL SEAL INSTALLER (35-43TONS) (EURO 4/5) DAF(CF 85)曲軸前油封安裝器(35-43噸)(4/5期環保)	H.C.B-A1441 P065 BENZ TRUCK (2640) DRIVE AXLE NUT SOCKET (Dr. 3/4",6 TEETH) BENZ卡車(2640)帶動軸螺帽套筒 (Dr. 3/4", 6齒)
H.C.B-B1636 P060 DAF (CF85) TRUCK CRANKSHAFT REAR OIL SEAL INSTALLER (35 - 43 TONS) (EURO 4/5) DAF (CF85)卡車曲軸後油封安裝器(35 - 43噸) (4/5期環保)	H.C.B-A1442 P065 BENZ TRUCK (2640) LIFT AXLE NUT SOCKET (Dr. 3/4",6 TEETH) BENZ卡車(2640)舉升軸螺帽套筒 (Dr. 3/4", 6齒)
H.C.B-A1678 P060 DAF 12 TONS (LF45) REAR AXLE NUT SOCKET DAF 12噸(LF45)後輪軸螺帽套筒	H.C.B-A1443 P065 BENZ TRUCK WHEEL AXLE NUT SOCKET (Dr.1") BENZ卡車輪軸螺帽套筒 (Dr. 1")
H.C.B-A1679 P060 DAF 17 TONS (LF55/ CF65) TRANSMISSION INPUT SHAFT OIL SEAL REMOVER / INSTALLER DAF 17噸(LF55/ CF65)變速箱輸入軸油封拆裝工具	H.C.B-A1387 P066 BENZ AXLE NUT SOCKET (H36, 12 POINTS, 95mm) BENZ輪軸螺帽套筒(H36, 12角, 95mm)
H.C.B-A1682 P061 DAF 17 TONS (LF55/ CF65) TRUCK CRANKSHAFT FRONT OIL SEAL INSTALLER DAF 17噸 (LF55/ CF65)卡車曲軸前油封安裝工具	H.C.B-B1387 P066 IVECO AXLE NUT SOCKET (H36, 12 POINTS, 110mm) IVECO輪軸螺帽套筒(H36, 12角, 110mm)
	H.C.B-C1387 P066 IVECO AXLE NUT SOCKET (H36, 12 POINTS, 105mm) IVECO輪軸螺帽套筒(H36, 12角, 105mm)
	H.C.B-A1411-95 P067 BENZ AXLE NUT SOCKET (H36, 6 POINTS, 95mm) BENZ 輪軸螺帽套筒(H36, 6角, 95mm)

H.C.B-A1411-98 P067 IVECO AXLE NUT SOCKET (H36, 6 POINTS, 98mm, Dr.3/4") IVECO 輪軸螺帽套筒 (H36,6 角, 98mm, Dr.3/4")	H.C.B-A1482 P074 BENZ REAR AXLE NUT SOCKET (Dr.3/4", 105-125mm) BENZ 後輪軸螺帽套筒 (Dr.3/4", 105-125mm)
H.C.B-A1601 P067 IVECO 3.5/7 TONS OIL FILTER WRENCH (Dr. 1/2", 10 FLUTES, 94.5 mm) IVECO 3.5/7 噸機油芯扳手 (Dr. 1/2", 10 角, 94.5mm)	H.C.B-A1483 P074 BENZ & MAN REAR AXLE NUT SOCKET (Dr.3/4", 80-95mm) BENZ & MAN 後輪軸螺帽套筒 (Dr.3/4", 80-95mm)
H.C.B-A1561 P068 IVECO WHEEL NUT SOCKET (Dr.1", 12 POINT, 85mm) IVECO 輪軸螺帽套筒 (Dr.1", 12角, 85mm)	H.C.B-A1922 P074 BENZ REAR AXLE NUT SOCKET (Dr.3/4",101.5mm,12 POINTS) BENZ 後輪軸螺帽套筒 (Dr.3/4", 101.5mm, 12角)
H.C.B-A1603 P068 IVECO 3.5/ 7 TONS TIRE NUT CROSS WRENCH (27mm) IVECO 3.5/7噸輪胎螺絲十字扳手(27mm)	H.C.B-A1448 P075 SAF BUSH REMOVAL/ INSTALLATION TOOL KIT SAF鐵套拆裝工具組
H.C.B-A1740 P068 IVECO (12/ 17 TONS) STEERING MECHANISM NUT WRENCH IVECO (12/17噸) 方向機螺帽扳手	H.C.B-A1466 P075 SAF WHEEL SHAFT COVER SOCKET (Dr.1",8 POINTS,130mm) SAF 輪軸蓋拆裝套筒 (Dr.1", 8角, 130mm)
H.C.B-A1618 P069 IVECO DUAL GEAR ENGINE FLYWHEEL ROTATOR (WITH 2 GEARS) IVECO DUAL 齒輪引擎飛輪轉動器(2 齒)	H.C.B-A1868 P075 SAF AXLE BRAKE DISC NUT SOCKET (Dr. 1/2", 12 POINTS, 13 mm) SAF輪軸碟盤螺帽套筒 (Dr. 1/2", 12 角, 13 mm)
H.C.B-A1634 P069 RENAULT MAGNUM TRUCK/ CAT ENGINE BARRING ENGINE FLYWHEEL ROTATOR (Dr.1/2") RENAULT MAGNUM/ CAT 卡車引擎飛輪轉動器(Dr.1/2")	H.C.B-A1492 P075 BENZ & MAN FLYWHEEL ROTATING TOOL (WITH 2 GEARS) (Dr. 1/2") BENZ & MAN卡車飛輪轉動工具(2齒) (Dr. 1/2")
H.C.B-A1280 P069 YORK REAR WHEEL NUT SOCKET (8 POINTS, 95mm) YORK後輪螺帽拆裝套筒 (8角, 95mm)	H.C.B-A1493 P076 BENZ & MAN FLYWHEEL ROTATING TOOL (WITH 3 GEARS) (Dr. 1/2") BENZ & MAN卡車飛輪轉動工具(3齒) (Dr. 1/2")
H.C.B-A1422 P069 BENZ TRUCK FILTER WRENCH (46mm) BENZ 卡車機油芯套筒 (46mm)	H.C.B-A1494 P076 MAN FLYWHEEL ROTATING TOOL (WITH 1 GEAR) (Dr. 1/2") MAN 飛輪轉動工具 (1齒) (Dr. 1/2")
H.C.B-A1282 P070 YORK ROTATING AXLE SHAFT TIE ROD BUSH REMOVAL/ INSTALL TOOL KIT YORK自轉軸橫拉桿鐵套拆裝工具組	H.C.B-A1557-50 P076 BENZ ACTROS AXLE BOLT SOCKET (32 EPL, L:50mm) BENZ ACTROS 輪軸螺絲套筒(32 EPL, L:50mm)
H.C.B-A1283 P070 FUWA WHEEL SHAFT COVER SOCKET (Dr. 1", 8 POINTS, 123mm) 福華板車輪軸蓋拆裝套筒 (Dr. 1", 8角, 123mm)	H.C.B-A1557-90 P077 BENZ ACTROS AXLE BOLT SOCKET(32 EPL, L:90mm) BENZ ACTROS 輪軸螺絲套筒(32 EPL, L:90mm)
H.C.B-A2178 P070 TRUCK INJECTION NOZZLE SOCKET 卡車噴油嘴拆裝套筒	H.C.B-A2018-26 P077 BENZ/ HINO TRUCK/ HYUNDAI UNIVERSE OIL MIST SEPARATOR WRENCH (Dr. 1/2", 12 RIBS · 96 mm) BENZ/HINO卡車/HYUNDAI 巴士 油水分離器扳手 (Dr. 1/2", 12齒 · 96 mm)
H.C.B-A2212 P071 TRUCK INJECTOR SOCKET SET (4 PCS) 卡車噴油嘴套筒組(4 PCS)	H.C.B-A1667 P077 BENZ TRUCK LIFT SHAFT WRENCH (360 / 410 / 440 / 460 / 480 / 550) BENZ卡車舉升車頭扳手(360 / 410 / 440 / 460 / 480 / 550)
H.C.B-A2222 P071 DIESEL INJECTOR SOCKET SET (4 PCS) 柴油噴油嘴套筒組(4 PCS)	H.C.B-A1871-60 P078 BENZ TRUCK FRAME RAIL NUT SOCKET (Dr. 3/4" , E30, 60 mm) 賓士卡車車道螺帽套筒 (Dr. 3/4", E30, 60 mm)
H.C.B-A1390 P072 EUROPEAN TRUCK DISC BRAKE CALIPER SOCKET(Dr.3/8",11 TEETH) 歐系卡車碟煞卡鉗套筒(Dr.3/8",11 齒)	H.C.B-A1871-90 P078 BENZ TRUCK FRAME RAIL NUT SOCKET (Dr. 3/4" , E30, 90 mm) 賓士卡車車道螺帽套筒 (Dr. 3/4", E30, 90 mm)
H.C.B-A1403 P072 BPW (12 TONS) TRAILER OIL SEAL INSTALLER BPW 12噸板車輪軸油封安裝器	H.C.B-A1661 P078 BENZ (2636) TRUCK REAR WHEEL AXLE NUT SOCKET (Dr. 3/4") BENZ (2636) 卡車 後輪雙軸螺帽套筒 (Dr. 3/4")
H.C.B-A1434 P072 LIEBHERR CRANE WHEEL SOCKET (Dr.1") LIEBHERR 吊車輪軸蓋套筒(Dr.1")	H.C.B-A1709 P078 BENZ (2640/ 2644/ 2648)TRUCK TRAILER HEAD LIFTING AXLE NUT SOCKET (Dr. 3/4",100 mm, 6 TEETH) BENZ (2640/ 2644/ 2648)拖車頭舉升輪軸螺帽套筒 (Dr. 3/4",100 mm, 6齒)
H.C.B-A1404 P073 RORTRAILER REAR WHEEL NUT SOCKET (Dr.1", 8 POINT, 83mm,3 1/4") (DRUM BRAKE) ROR 板車輪軸螺帽套筒 (Dr.1", 8角, 83mm, 3 1/4") (鼓式煞車)	H.C.B-A1736 P079 MERCEDES - BENZ DIFFERENTIAL NUT SOCKET (72 mm) MERCEDES - BENZ 差速器螺帽套筒 (72 mm)
H.C.B-B1488-120 P073 ROR REAR WHEEL HUB NUT SOCKET (DISC BRAKE) (Dr. 1", 8 POINT, 120mm) ROR 板車輪軸螺帽套筒 (碟式煞車) (Dr.1", 8角, 120mm)	

H.C.B-A1581 P079	New H.C.B-A1924 P085
VOLVO (FM) CRANKSHAFT REAR OIL SEAL INSTALLER VOLVO (FM) 曲軸後油封安裝器	DAF TRUCK FLYWHEEL ROTATOR (EURO 586) DAF 卡車曲軸飛輪轉動器 (EURO 586)
H.C.B-A1582 P079	New H.C.B-A1947 P085
VOLVO (FM12) TRANSMISSION OIL TUBE NUT WRENCH (74 mm) VOLVO (FM12) 變速箱油管螺帽扳手 (74 mm)	IVECO/ IRIS BUS SPECIAL SOCKET(Dr.1", 12 POINTS, 105 mm) IVECO/ IRIS巴士 特殊套筒 (Dr.1", 12 POINTS, 105 mm)
H.C.B-A1610 P080	New H.C.B-A1948 P086
VOLVO (FM) CRANKSHAFT FRONT OIL SEAL INSTALLER VOLVO (FM) 曲軸前油封安裝工具	HGV BRAKE CALIPER SLOGGING WRENCH KIT (E18/E20/E24/M24/M26, Dr. 3/4") HGV 煞車卡鉗衝擊扳手 (E18/E20/E24/M24/M26, Dr. 3/4")
H.C.B-A1177 P080	New H.C.B-A1923 P086
TOYOTA ZACE/DAF BALL JOINT EXTRACTOR (32mm) TOYOTA 瑞獅/DAF 方向機主機球頭拆卸器 (32mm)	VOLVO (FM12) SERPENTINE BELT ADJUST TOOL VOLVO (FM12) 惰輪皮帶調整扳手
H.C.B-A1675 P080	
VOLVO TRUCK CAMSHAFT LIFTING TOOL VOLVO 卡車凸輪軸吊起工具	
H.C.B-A1600 P081	
KENWORTH LEAF SPRING PIN& BUSHING REMOVAL/ INSTALLATION TOOL KIT USA PAT. PAT. M508410 KENWORTH 彈簧插銷&鐵套拆裝工具組 USA PAT. PAT. M508410	
New H.C.B-B1773 P081	
TRAILER BUCKET STAND 板車車斗固定架	
New H.C.B-A1773 P081	
BPW TRAILER BUCKET STAND BPW 板車車斗固定架	
H.C.B-A1669 P082	
UNIVERSAL TRUCK REAR WHEEL HUB PULLER 萬用卡車後輪軸拔卸器	
New H.C.B-A1789 P082	
BENZ TRUCK (DD13/ DD15) DIESEL ENGINE FRONT CRANKSHAFT OIL SEAL REMOVER/ INSTALLER BENZ 卡車 (DD13/ DD15) 柴油引擎前曲軸油封拆裝工具	
New H.C.B-A1788 P082	
BENZ TRUCK (OM401/ OM403/ OM421 ~ OM423/ OM441 ~ OM444/ OM447/ OM457/ OM458/ OM541/ OM542/ OM941/ OM942) DIESEL ENGINE FRONT CRANKSHAFT OIL SEAL REMOVER BENZ 卡車 (OM401/ OM403/ OM421 ~ OM423/ OM441 ~ OM444/ OM447/ OM457/ OM458/ OM541/ OM542/ OM941/ OM942) 柴油引擎前曲軸油封拆卸 工具	
H.C.B-A1569 P083	
SCANIA LIFT AXLE LUG PIN REMOVAL TOOL KIT (W/HYDRAULIC) SCANIA 舉升軸吊耳插銷拆卸工具組 (油壓)	
New H.C.B-A1931 P084	
BENZ TRUCK ACTROS/ATEGO OIL SEAL INSTALLER BENZ TRUCK ACTROS/ATEGO 油封安裝器	
New H.C.B-A1794 P084	
RENAULT TRUCK HUB SOCKET (Dr. 1" , 6 POINTS, 77 mm) RENAULT 卡車輪殼套筒 (Dr. 1", 6 角, 77 mm)	
New H.C.B-A1797 P084	
IVECO DUAL GEAR ENGINE FLYWHEEL ROTATOR (WITH 2 GEARS) IVECO 卡車引擎飛輪轉動器 (2齒)	
New H.C.B-A1836 P085	
DAF 12-SPEED TRANSMISSION DISASSEMBLE BASE DAF 12速變速箱分解底座	
New H.C.B-A1845 P085	
FORD TRANSIT REAR HUB NUT SOCKET FORD TRANSIT 後殼螺帽套筒	

IVECO 卡車修護工具 IVECO Truck Repair Tool

H.C.B-IV1001 P088
IVECO/ FUSO CRANKSHAFT FRONT OIL SEAL REMOVAL TOOL IVECO/ FUSO 前曲軸油封拆卸工具
H.C.B-A1676 P088
IVECO/ FUSO (3.5 TONS) TRUCK CRANKSHAFT FRONT OIL SEAL INSTALLATION TOOL IVECO/ FUSO (3.5噸) 卡車曲軸前油封安裝工具
H.C.B-IV1002 P088
IVECO/ FUSO CRANKSHAFT REAR OIL SEAL REMOVEAL TOOL IVECO/ FUSO 後曲軸油封拆卸工具
H.C.B-B1676 P089
IVECO/ FUSO (3.5 TONS) TRUCK CRANKSHAFT REAR OIL SEAL INSTALLATION TOOL IVECO/ FUSO (3.5噸) 卡車曲軸後油封安裝工具
H.C.B-IV1003 P089
IVECO/ FUSO INJECTOR REMOVER IVECO/ FUSO 噴油嘴拆卸工具
H.C.B-IV1004 P089
IVECO EXTRACTOR REACTION BLOCK IVECO 變速箱拉拔器頭
H.C.B-IV1006 P090
IVECO/ FUSO TIMING GEAR COVER CENTERING RING IVECO/ FUSO 正時外蓋定位工具
H.C.B-IV1008 P090
IVECO LOWER SWINING ARM BALL JOINT REMOVER IVECO 大王銷拆卸工具
H.C.B-IV1009 P090
IVECO STERRING TIE ROD END/ SUSPENSION ARM BALL JOINT SEPARATOR (25.5mm) IVECO 橫直拉桿球頭拉拔器 (25.5mm)
H.C.B-IV1010 P091
IVECO/ FUSO INJECTOR PIPES WRENCH (17 mm) IVECO/ FUSO 噴油嘴油管套筒 (17 mm)
H.C.B-IV1011 P091
IVECO KING PIN LOCK RING WRENCH IVECO 大王銷固定環套筒

H.C.B-IV1012 P091

IVECO/ FUSO DRIVE SHAFT VALVE RETAINING TOOL
IVECO/ FUSO 轉向閥固定支架

H.C.B-IV1013 P092

IVECO/ FUSO ENGINE VALVE REMOVER/ INSTALLER
IVECO/ FUSO引擎汽門拆裝工具

H.C.B-IV1014 P092

IVECO/ FUSO FLYWHEEL COUNTER HOLDING TOOL
IVECO/ FUSO飛輪支撐工具

H.C.B-IV1015 P092

IVECO/ FUSO CAMSHAFT TIMING TOOL
IVECO/ FUSO凸輪軸正時工具

H.C.B-IV1016 P093

IVECO/ FUSO CRANKSHAFT TIMING TOOL
IVECO/ FUSO曲軸正時工具

H.C.B-IV1017 P093

IVECO GEARBOX OUTPUT SHAFT BEARING/ FLANGE INSTALLER
IVECO變速箱輸出軸培林/凸緣盤安裝工具

H.C.B-IV1018 P093

IVECO DIFFERENTIAL LOCATING PIN
IVECO差速器定位銷

H.C.B-IV1019 P094

IVECO TRANSMISSION OUTPUT SHAFT LOCKING TOOL
IVECO變速箱輸出軸固定工具

H.C.B-IV1020 P094

IVECO WHEEL HUB BEARING INSTALLER
IVECO輪殼培林安裝工具

H.C.B-IV1021 P094

IVECO TRANSMISSION REAR COVER OIL SEAL INSTALLER
IVECO變速箱後油封安裝工具

H.C.B-IV1022 P095

IVECO TRANSMISSION FRONT COVER OIL SEAL INSATLLER
IVECO變速箱前油封安裝工具

H.C.B-IV1023 P095

IVECO DIFFERENTIAL BEVEL PINION GASKET INSTALLER
IVECO差速器盆型齒輪安裝工具

H.C.B-IV1024 P095

IVECO/ FUSO ALTERNATOR PULLEY WRENCH
IVECO/ FUSO發電機皮帶盤拆裝工具

H.C.B-IV1025 P095

IVECO/ FUSO FLEXIBLE BELT INSTALLER
IVECO/ FUSO皮帶安裝工具

H.C.B-IV1026 P096

IVECO TRANSMISSION MAIN SHAFT/ COUNTER SHAFT/ FORK ASSEMBLY
REMOVER/ INSTALLER
IVECO變速箱主軸/副軸/撥叉總成拆裝工具

H.C.B-IV1027 P096

IVECO TRANSMISSION (INPUT SHFAT) FRONT CASING EXTRACTOR
IVECO變速箱(輸入軸)前蓋拉拔器

H.C.B-IV1028 P096

IVECO WHEEL HUB NUT SOCKET (Dr.3/4",12 POINTS, 65 mm)
IVECO輪殼螺帽套筒 (Dr.3/4",12角, 65 mm)

H.C.B-IV1029 P097

IVECO WHEEL HUB BEARING NUT SOCKET (Dr.3/4",6 POINTS, 91.5 mm)
IVECO輪殼培林螺帽套筒 (Dr.3/4",6角, 91.5 mm)

H.C.B-IV1030 P097

IVECO ABS SENSOR MOUNT POSITIONING TOOL
IVECO ABS感應器位置測量器

H.C.B-IV1031 P097

IVECO FRONT SUSPENSION SPRING SLEEVE REMOVER
IVECO前懸吊鐵套拆卸工具

H.C.B-IV1032 P098

IVECO FRONT SUSPENSION SPRING SLEEVE INSTALLER
IVECO前懸吊鐵套安裝工具

H.C.B-IV1033 P098

PISTON RING COMPRESSOR
活塞安裝工具

New H.C.B-A1915 P098

IVECO BRAKE CALIPER WIND BACK KIT
IVECO 煞車分泵調整組

日系卡車修護工具

Japanese Truck Repair Tool

H.C.B-A1127 P100

FUSO REAR WHEEL NUT SOCKET (8 POINTS, 120mm)
FUSO卡車後輪螺帽拆裝套筒 (8角, 120mm)

H.C.B-A1184 P100

HINO CRANKSHAFT REAR OIL SEAL INSTALLER (J08C/ JO8E)
HINO卡車曲軸後油封安裝器 (J08C/ JO8E)

H.C.B-B1184 P100

HINO CRANKSHAFT FRONT OIL SEAL INSTALLER
HINO卡車曲軸前油封安裝器

H.C.B-C1184 P101

HINO CRANKSHAFT FRONT OIL SEAL INSTALLER (J08C/ JO8E)
HINO卡車曲軸前油封安裝器 (J08C/ JO8E)

H.C.B-A1178 P101

FUSO/HINO PROFIA 700 STEERING MECHANISM OIL SEAL SOCKET (Dr. 1/2")
FUSO/HINO大將700 卡車方向機油封套筒 (Dr. 1/2")

H.C.B-B1178 P101

FUSO STEERING MECHANISM OIL SEAL SOCKET (Dr. 1/2") (UNDER 15 TONS)
FUSO 方向機油封套筒 (Dr. 1/2")(15噸以下)

H.C.B-C1178 P102

FUSO CANTER(3.5 TONS) STEERING GEAR OIL SEAL SOCKET
(Dr. 1/2") (EURO 4)
FUSO 堅達(3.5噸)方向機主機油封螺母套筒 (Dr. 1/2") (四期環保)

H.C.B-A1683 P102

FUSO (3.5/6.5~7.7 TONS)/ ISUZU 7.5 TONS TRUCK REAR AXLE NUT SOCKET
FUSO (3.5/6.5~7.7噸)/ ISUZU 7.5噸卡車後輪軸螺帽套筒

H.C.B-A1691 P102

FUSO AIR HOSE REMOVER
FUSO 氣管快拆扳手組

H.C.B-A1270 P103

HINO STEERING MECHANISM OIL SEAL SOCKET (Dr. 1/2")
HINO 方向機油封套筒 (Dr. 1/2")

H.C.B-A1210 P103

MITSUBISHI CANTER / FUSO AXLE BALL JOINT PULLER
三菱堅達/FUSO仰角球接頭拆卸器

H.C.B-A1248 P103

MITSUBISHI DELICA 2500 c.c. WHEEL NUT SOCKET (Dr. 1/2")
得利卡2500c.c. 輪軸螺帽套筒 (Dr. 1/2")

H.C.B-A1275 P104

HINO / ISUZU / FUSO / UD ANCHOR PIN REMOVER (HYDRAULIC)
HINO / ISUZU / FUSO / UD 剎車來令片插銷拔卸器 (油壓)

New **H.C.B-B1275** P104

HINO / ISUZU / FUSO / UD TRUCK ANCHOR PIN REMOVER
(12 TONS HYDRAULIC)
HINO / ISUZU / FUSO / UD 卡車剎車來令片插銷拔卸器 (12噸油壓)

H.C.B-A1286 P105

HINO 11.9 TONS REAR WHEEL AXLE NUT SOCKET (Dr. 3/4" , 8 POINTS, 105mm)
HINO 11.9噸後輪軸螺帽套筒 (Dr. 3/4" , 8角, 105mm)

H.C.B-B1056 P105

ISUZU 3.5 TONS/ FUSO CANTER 3.5 TONS REAR WHEEL AXLE NUT SOCKET
ISUZU 3.5噸/ FUSO CANTER 3.5 噸 後輪軸螺帽套筒

H.C.B-A1122 P105

ISUZU CRANKSHAFT OIL SEAL REPLACER
ISUZU 曲軸油封更換器

H.C.B-A1261 P106

ISUZU CRANKSHAFT REAR OIL SEAL INSTALLER (3.5 TONS)
ISUZU 曲軸後油封安裝器 (3.5噸)

H.C.B-B1261 P106

ISUZU CRANKSHAFT FRONT OIL SEAL INSTALLER (3.5 TONS)
ISUZU 曲軸前油封安裝器 (3.5噸)

New **H.C.B-A1849** P106

ISUZU (6UZ1) TRUCK CRANKSHAFT FRONT/ REAR OIL SEAL INSTALLER
ISUZU (6UZ1) 卡車曲軸前/後油封安裝器 (3.5噸)

H.C.B-A1351 P107

UD 350 (CK450)/ UD 380 (CK451) TRUCK CRANKSHAFT REAR OIL
SEALINSTALLER
UD 350 (CK450)/ UD 380 (CK451) 卡車曲軸後油封安裝器

H.C.B-B1351 P107

UD 17 TONS TRUCK CRANKSHAFT REAR OIL SEAL INSTALLATION TOOL KIT
UD 17噸 曲軸後油封安裝工具組

H.C.B-A1066-5 P107

UNIVERSAL AXLE EXTRACTOR (FOR TRUCKS ONLY)
萬用輪軸拔卸器 (卡車專用)

H.C.B-A1397 P108

UD TRUCKS (CW520, CW530) CRANKSHAFT REAR OIL SEAL INSTALLER
UD 卡車 (CW520, CW530) 曲軸後油封安裝器

H.C.B-C1102 P108

JAPANESE TRUCK BALL JOINT REMOVER (39mm) PAT. M 362085
日系卡車球接頭拔卸器 (39mm)

H.C.B-A1179 P109

PITMAN ARM PULLER (Dr. 3/4" , 62 mm)
方向機搖臂拔卸器 (Dr. 3/4" , 62mm)

H.C.B-A1180 P109

PITMAN ARM PULLER (Dr. 3/4" , 47mm)
方向機搖臂拔卸器 (Dr. 3/4" , 47mm)

H.C.B-B1181 P109

ISUZU, FUSO, TOYOTA SPRING PIN METAL BUSH REMOVAL/ INSTALLATION
TOOL KIT (HYDRAULIC)
ISUZU, FUSO, TOYOTA 卡車彈簧銷拆裝工具組 (油壓式)

H.C.B-A1472 P110

FUSO TRUCK TRANSMISSION/ SHAFT SLEEVE PULLER SET
FUSO 卡車變速箱/軸套拆卸組

H.C.B-A1338 P110

TRUCK VALVE REMOVER / INSTALLER
卡車汽門拆裝器

H.C.B-A1439 P110

JAPANESE TRUCK WHEEL NUT SOCKET
日本卡車輪軸螺帽套筒

H.C.B-A1170 P111

TRUCK TORQUE-ROD BUSH REMOVAL/ INSTALLATION TOOL KIT
PAT.M307531
卡車扭力桿鐵套拆裝工具組

H.C.B-A1415 P112

HINO #700 BRAKE ADJUSTMENT WRENCH
HINO #700 煞車調整扳手

H.C.B-B1415 P112

HINO #700 BRAKE ADJUSTMENT WRENCH
HINO #700 煞車調整扳手

H.C.B-A1495-1 P112

ISUZU PETROL OIL MIST SEPARATE WRENCH (Dr.1/2")
ISUZU 汽油油水分離器扳手 (Dr. 1/2")

H.C.B-A1495-2 P112

ISUZU PETROL OIL MIST SEPARATE DRAIN SOCKET (Dr.1/2")
ISUZU 汽油油水分離器套筒 (Dr.1/2")

H.C.B-C1491 P113

HINO (JO8C/JO8E) TRUCK INJECTION NOZZLE PULLER/ INJECTION NOZZLE
SLEEVE REMOVAL/ INSTALLATION TOOL KIT
HINO (JO8C/JO8E) 噴油嘴拆卸器/噴油嘴套筒拆裝工具組

H.C.B-B1491 P113

HINO (JO8C/JO8E) TRUCK INJECTION NOZZLE SLEEVE REMOVAL/
INSTALLATION TOOL KIT
HINO (JO8C/JO8E) 噴油嘴套筒拆裝工具組

H.C.B-A1491 P113

HINO (JO8C/JO8E) TRUCK INJECTION NOZZLE PULLER
HINO (JO8C/JO8E) 卡車噴油嘴拆卸器

H.C.B-A1628 P114

FUSO CANTER FUEL FILTER WRENCH (EURO 5) (Dr. 1/2") (50 mm)
FUSO 堅達柴油濾芯扳手 (五期環保) (Dr. 1/2") (50 mm)

H.C.B-A1520 P114

Dr. 1" , COMBINATION BUDD WHEEL IMPACT SOCKET (1-1/2" x13/16" ,
41x21 mm, 38x20 mm, 35x17 mm, 38x19 mm) (5PCS)
Dr. 1" 卡車輪胎套筒組 (1-1/2" x13/16" , 41x21 mm, 38x20 mm, 35x17 mm,
38x19 mm) (5PCS)

H.C.B-A2313 P114

IDr .1" TRUCK WHEEL SOCKET (12PT) (41x21mm)
Dr .1" 卡車輪胎套筒 (12角) (41x21mm)

H.C.B-B2313 P115

Dr. 1/2" TRUCK WHEEL SOCKET (12PT) (41x21mm)
Dr. 1/2" 卡車輪胎套筒(12角) (41x21mm)

H.C.B-A1579 P115

HINO (E13C) CRANKSHAFT FRONT OIL SEAL INSTALLER (700)
HINO (E13C) 曲軸前油封安裝工具組 (700 型)

H.C.B-B1579 P115

HINO (E13C) CRANKSHAFT REAR OIL SEAL INSTALLER (700)
HINO (E13C) 曲軸後油封安裝工具組 (700 型)

H.C.B-C1579 P116

HINO (F20C) TRUCK CRANKSHAFT FRONT OIL SEAL INSTALLER TOOL KIT (21 TONS)
HINO (F20C) 曲軸前油封安裝器 (21噸)

New **H.C.B-D1579** P116

HINO (K13C) TRUCK CRANKSHAFT FRONT OIL SEAL INSTALLER
HINO (K13C) 卡車曲軸前油封安裝工具

H.C.B-A1586 P116

HINO 11 TONS WHEEL SPEED SENSOR REMOVAL/ INSTALLATION TOOL KIT
HINO 11噸輪速感應片拆裝工具

H.C.B-A1625 P117

HINO (P11C/K13C) CRANKSHAFT REAR OIL SEAL INSTALLATION TOOL KIT
HINO (P11C/K13C) 曲軸後油封安裝工具組

H.C.B-B1059 P117

UNIVERSAL CALIPER PRESSURE TOOL (FOUR PISTONS)
通用型分泵回復器(四活塞)

H.C.B-A1635 P117

ISUZU 35 TONS (6WG1/6WA1) CRANKSHAFT FRONT OIL SEAL/FAN AXLE OIL SEAL INSTALLER
ISUZU 35 噸 (6WG1/6WA1) 曲軸前油封及風扇軸油封安裝工具

H.C.B-A1726 P118

ISUZU (4JJ1) CRANKSHAFT FRONT OIL SEAL INSTALLER (3.5 TONS)
ISUZU (4JJ1) 曲軸前油封安裝器 (3.5噸)

H.C.B-B1726 P118

ISUZU (4JJ1) TRUCK CRANKSHAFT REAR OIL SEAL INSTALLER (3.5 TONS)
ISUZU (4JJ1) 卡車曲軸後油封安裝器 (3.5噸)

H.C.B-A1673 P118

HINO (17 TONS) TRUCK BRAKE BOOSTER SOCKET
HINO (17 噸) 卡車煞車增壓輔助器套筒

New **H.C.B-C1681** P119

FUSO/ HINO REAR BRAKE SHOES INSTALLATION TOOL KIT
FUSO/ HINO 後輪煞車片安裝工具組

H.C.B-A1681 P119

FUSO/ HINO TRUCK REAR BRAKE SHOES INSTALLATION TOOL KIT
FUSO/ HINO 卡車後輪煞車片安裝工具組

H.C.B-A2018 P119

MITSUBISHI CANTER 3.5 TONS/ FUSO OIL FILTER WRENCH (Dr. 1/2", 15 POINTS, 100mm)
三菱堅達3.5噸/FUSO機油芯扳手 (Dr. 1/2", 15角, 100mm)

H.C.B-A2018-1 P120

MITSUBISHI NEW CANTER 8.8 TONS OIL FILTER WRENCH (TURBO) (Dr. 1/2", 15 POINTS, 101mm)
三菱新堅達8.8噸機油芯扳手 (Dr. 1/2", 15角, 101mm)

H.C.B-A2018-2 P120

HINO 15 TONS OIL FILTER WRENCH (Dr. 1/2", 16 POINTS, 108 mm)
HINO 15噸機油芯扳手 (Dr. 1/2", 16角, 108mm)

H.C.B-A2018-5 P120

ISUZU ELF OIL FILTER WRENCH (Dr. 1/2", 15 POINTS, 89mm)
ISUZU 一路發機油芯扳手 (Dr. 1/2", 15角, 89 mm)

H.C.B-A2018-11 P120

FUSO NEW CANTER 3.5/11 TONS (EURO 4) DIESEL FILTER WRENCH (Dr. 1/2", 109 mm)
FUSO新堅達 3.5/11噸 (4期) 柴油濾芯扳手 (Dr. 1/2", 109 mm)

H.C.B-A2018-12 P121

MITSUBISHI ALL NEW CANTER DIESEL OIL AND WATER SENSOR WRENCH (12 POINTS, 54mm)
三菱新堅達柴油車油水感應器扳手 (12角, 54mm)

H.C.B-A2018-13 P121

UD (EURO 5)/ ISUZU/ HINO 17 TONS OIL FILTER WRENCH (EURO 4) (Dr. 1/2", 16 POINTS, 118 mm)
UD (五期)/ ISUZU/ HINO 17噸機油芯扳手 (四期環保) (Dr. 1/2", 16角, 118mm)

H.C.B-A2018-14 P121

MITSUBISHI VERYCA (1200 c.c.) OIL FILTER WRENCH (EURO 4) (14 POINTS, 66.5mm)
中華菱利 (1200 c.c.) 機油芯扳手 (四期) (14角, 66.5mm)

H.C.B-A2018-17 P121

FUSO (6.5/ 6.8/ 7.7 TONS) TRUCK OIL FILTER WRENCH (Dr. 1/2", 16 POINTS, 106.5mm)
FUSO (6.5/ 6.8 /7.7噸) 卡車機油芯扳手 (Dr. 1/2", 16角, 106.5mm)

H.C.B-A2018-18 P122

FUSO (10.5 ~ 17 TONS) TRUCK OIL FILTER WRENCH (Dr. 1/2", 15 POINTS, 119mm)
FUSO (10.5 ~ 17噸) 卡車機油芯扳手 (Dr. 1/2", 15角, 119mm)

H.C.B-A2018-20 P122

FUSO TRUCK OIL MIST SEPARATOR WRENCH (Dr. 1/2", 8 RIBS, 109 mm)
FUSO 卡車油水分離器扳手 (Dr. 1/2", 8齒, 109 mm)

H.C.B-A2018-21 P122

HINO TRUCK/ISUZU (3.5 TONS) (EURO 4/ NL EURO 5) OIL MIST SEPARATOR WRENCH (Dr. 1/2", 8 RIBS, 107mm)
HINO 卡車/ISUZU 3.5噸 (四期環保車/NL 五期環保車) 油水分離器扳手 (Dr. 1/2", 8齒, 107mm)

H.C.B-A2018-22 P123

ISUZU (4.9~7.9 TONS) TRUCK OIL FILTER WRENCH (Dr. 1/2", 15 POINTS, 118mm)
ISUZU (4.9~7.9噸) 卡車機油芯扳手 (Dr. 1/2", 15角, 118mm)

H.C.B-A2018-23 P123

HINO (EURO 4/5) (3.5 ~ 7.4 TONS) TRUCK OIL FILTER WRENCH (Dr. 1/2", 15 POINTS, 101.5mm)
HINO (四期/五期) (3.5 ~ 7.4 噸) 卡車機油芯扳手 (Dr. 1/2", 15 角, 101.5mm)

H.C.B-A2018-24 P123

FUSO (6D16) MEDIUM-SIZED TRUCK OIL FILTER WRENCH (Dr. 1/2", 16 POINTS, 123mm)
FUSO (6D16) 機油芯扳手 (Dr. 1/2", 16角, 123 mm)

H.C.B-A2018-25 P123

FUSO (6D16) 11 TONS TRUCK REMOVAL TOOL FOR FUEL FILTER (Dr. 1/2", 15 POINTS · 93mm)
FUSO (6D16) 11噸卡車柴油濾芯扳手 (Dr. 1/2", 15 角, 93mm)

H.C.B-A2018-28 P124

ISUZU 3.5 TONS (EURO 4/5) TRUCK DIESEL FILTER WRENCH (Dr. 1/2", 12 RIBS, 100mm)
ISUZU 3.5噸 (四/五期環保) 卡車柴油濾芯扳手 (Dr. 1/2", 12齒, 100mm)

H.C.B-A2018-29 P124

HINO (3.5/7.5/8.5 TONS) (EURO 5) TRUCK DIESEL FILTER WRENCH (15 POINTS, 101 mm)
HINO (3.5/7.5/8.5 噸) (五期) 卡車柴油濾芯扳手 (15角, 101 mm)

	H.C.B-A2018-30	P124
	HINO (3.5/7.5/8.5 TONS) (EURO 5) TRUCK DIESEL OIL MIST SEPARATOR WRENCH (Dr. 1/2", 12 RIBS, 86 mm) HINO (3.5/7.5/8.5 噸) (五期)卡車柴油油水分離器扳手 (Dr. 1/2", 12齒, 86 mm)	
New	H.C.B-A2018-31	P125
	FUSO (6D 16/17) TRUCK OIL FILTER WRENCH (Dr. 1/2", 18 POINTS, 124 mm) FUSO (6D 16/17) 卡車機油芯扳手 (Dr. 1/2", 18角, 124 mm)	
	H.C.B-A2130	P125
	MITSUBISHI CANTER DIESEL OIL FILTER REMOVER/ INSTALLER 三菱堅達柴油車機油芯拆裝工具	
New	H.C.B-A1791	P125
	FUSO (8.8/ 10.4 TONS) CRANKSHAFT FRONT OIL SEAL PULLEY REMOVER 三菱FUSO (8.8/ 10.4噸) 曲軸前油封皮帶盤拆卸工具	
New	H.C.B-A1792	P125
	FUSO (4D 33) TRUCK CRANKSHAFT REAR OIL SEAL INSTALLER FUSO (4D 33) 卡車曲軸後油封安裝工具	
New	H.C.B-A1793	P126
	FUSO (6D 17) TRUCK CRANKSHAFT REAR OIL SEAL INSTALLER FUSO (6D 17) 卡車曲軸後油封安裝工具	
New	H.C.B-A2018-33	P126
	ISUZU (6HK1) (3.5 TONS) 150P TRUCK DIESEL OIL MIST SEPARATOR WRENCH (Dr. 1/2", 8 RIBS, 106 mm) ISUZU (6HK1) (3.5 噸) 150P 卡車柴油油水分離器扳手 (Dr. 1/2", 8齒, 106 mm)	
New	H.C.B-A2018-34	P126
	FUSO 17 TONS TRUCK OIL FILTER WRENCH (Dr. 1/2", 18 POINTS, 123.2 mm) FUSO 17噸卡車機油芯扳手 (Dr. 1/2", 18角, 123.2 mm)	
New	H.C.B-A2018-36	P126
	ISUZU 11 TONS TRUCK DIESEL OIL MIST SEPARATOR WRENCH (Dr. 1/2", 8 RIBS, 118.7 mm) ISUZU 11 噸 卡車柴油油水分離器扳手 (Dr. 1/2", 8齒, 118.7 mm)	
New	H.C.B-A2018-37	P127
	MITSUBISHI/ NISSAN UD TRUCK OIL FILTER WRENCH (Dr. 1/2", 6POINTS, 124 mm) MITSUBISHI/ NISSAN UD卡車機油芯扳手 (Dr. 1/2", 6POINTS, 124 mm)	
New	H.C.B-A1814	P127
	UD CWB5E TRANSMISSION REMOVEAL TOOL KIT UD CWB5E 變速箱分解工具組	
New	H.C.B-A1932	P127
	FUSO (EURO 5) TRUCK FUEL PIPE REMOVAL TOOL FUSO (EURO 5) 卡車燃油管拆卸工具	
New	H.C.B-A1933	P127
	FUSO (EURO 5) TRUCK CLUTCH SEAL INSTALLATION TOOL FUSO (EURO 5) 卡車離合器油封安裝工具	
New	H.C.B-A1934	P128
	ISUZU RT50 TRUCK TRANSMISSION SPINDLE REMOVAL TOOL KIT ISUZU RT50 卡車變速箱主軸拆卸工具組	
New	H.C.B-A1964	P128
	ISUZU / JACKAROO INJECTOR SLEEVE REMOVER(4JX1 / 4XJ1) ISUZU / JACKAROO 噴油嘴銅套拆卸器(4JX1 / 4XJ1)	

通用卡車修護工具
General Truck Repair Tool

H.C.B-A1102	P130
TRUCK BALL JOINT REMOVER(39mm) PAT. M 362085 卡車球接頭拆卸器(39mm)	
H.C.B-A1407	P130
UNIVERSAL TRUCK BALL JOINT REMOVER (32mm) 萬用球接頭拆卸器(32mm)	
H.C.B-A1112	P131
MEDIUM-SIZED WAGON BALL JOINT EXTRACTOR (32mm) PAT. 中型貨車球接頭拆卸器(32mm)	
H.C.B-A1165	P131
PICKUP TRUCK & BUS BALL JOINT EXTRACTOR (30mm) 小型卡車、遊覽車球頭拆卸器(30mm)	
H.C.B-A1009	P131
AUTOMATIC TRANSMISSION CLUTCH SPRING COMPRESSOR 自動變速箱離合器壓版拆裝工具	
H.C.B-A1082-1	P132
UNIVERSAL BALL JOINT SEPARATOR (SCREW REPLACEABLE) (24mm) PAT. 208928 萬用球接頭拆卸組(可替換螺絲)(24mm)	
H.C.B-B1182	P132
UNIVERSAL TRUCK BALL JOINT PULLER (REPLACEABLE) (24mm & 32mm) - IMPROVEMENT PAT. M 384746 萬用卡車可換式球接頭拆卸器(24mm & 32mm)-改良型	
H.C.B-A1410	P132
UNIVERSAL TRUCK BALL JOINT REMOVER(39mm) PAT.438423 萬用球接頭拆卸器(39mm)	
H.C.B-C1410	P133
UNIVERSAL TRUCK BALL JOINT REMOVER (39mm) (W/HYDRAULIC SPINDLE) PAT.438423 萬用球接頭拆卸器 (39mm)(油壓桿)	
H.C.B-A1225	P134
TRUCK BALL JOINT PULLER (32mm) (HYDRAULIC) 卡車球頭拆卸器(32mm)(油壓式)	
H.C.B-A1226	P134
TRUCK BALL JOINT PULLER (39mm) (HYDRAULIC) 卡車球頭拆卸器(39mm)(油壓式)	
H.C.B-A1120	P134
TRUCK TRANSMISSION BEARING PULLER 卡車變速箱培林拆卸器	
H.C.B-A1120-308	P135
ISUZU TRUCK TRANSMISSION BEARING PULLER (OPTIONAL ACCESSORY) ISUZU卡車變速箱培林拆卸組(選購配件)	
H.C.B-A1120-309	P135
HINO KUOZUI 15 TONS TRUCK TRANSMISSION BEARING PULLER (OPTIONAL ACCESSORY) HINO國瑞15噸卡車變速箱培林拆卸組(選購配件)	
H.C.B-A1120-310	P135
SCANIA TRUCK TRANSMISSION BEARING PULLER (OPTIONAL ACCESSORY) SCANIA卡車變速箱培林拆卸組 (選購配件)	
H.C.B-A1191	P135
UNIVERSAL BALL JOINT SEPERATOR (22mm) 萬用球接頭拆裝工具組 (22mm)(橫拉桿)	

H.C.B-B1120 P136	H.C.B-A1054-2 P143
TRUCK TRANSMISSION BEARING PULLER 中型貨車變速箱培林拆卸器	UNIVERSAL SEPARATOR (R2) PAT. 172921 萬用拆卸器(R2)
H.C.B-B1120-A P136	H.C.B-A1054-4 P143
FUSO TRUCK LAY SHAFT BEARING PULLER FUSO 卡車副軸培林拆卸器	STEERING WHEEL PULLER BOLT (EXTENDED) 方向盤拆卸器螺絲(加長型)
H.C.B-B1120-B P136	H.C.B-A1287 P143
ISUZU 6.8 TONS TRUCK MAIN SHAFT BEARING PULLER ISUZU 6.8噸卡車主軸培林拆卸器	DAEWOO TRUCK WHEEL AXLE NUT SOCKET (Dr. 3/4", 6 POINTS, 116mm) 大宇卡車輪軸螺帽套筒(Dr. 3/4", 6角, 116mm)
H.C.B-B1120-C P136	H.C.B-A2018-27 P144
ISUZU MEDIUM TRUCK BEARING PULLER ISUZU 中型卡車培林拆卸器	HYUNDAI PORTER/KIA MOTOR TRUCK OIL FILTER WRENCH (Dr. 1/2", 15 POINTS · 91.7mm) HYUNDAI PORTER/KIA MOTOR卡車機油芯扳手 (Dr. 1/2", 15角 · 91.7mm)
H.C.B-A1187 P137	H.C.B-A2013 P144
PNEUMATIC BRAKE LINING SHOE LOADER 卡車剎車來令拆裝機(氣壓式)	TRANSMISSION FLOOR JACK (1 TON) 臥式變速箱千斤頂(1噸)
H.C.B-C1181 P137	H.C.B-A2101 P144
TRUCK SPRING PIN METAL BUSH REMOVAL / INSTALLATION KIT (HYDRAULIC) 卡車彈簧鋼套/插銷拆裝工具組(油壓式)	UNIVERSAL ADJUSTABLE WHEEL BEARING LOCK NUT WRENCH 後軸螺帽拆卸器(萬用型)
H.C.B-D1181 P137	H.C.B-F1168 P145
TRUCK SPRING PIN METAL BUSH REMOVAL / INSTALLATION KIT (17 TONS HYDRAULIC CYLINDER) 卡車彈簧鋼拆裝工具組(17噸油壓式)	UNIVERSAL BALL JOINT SERVICE KIT PAT M.333280 專利型萬象十字接頭拆卸器 PAT M.333280
H.C.B-E1181 P138	H.C.B-A1850 P145
TRUCK SPRING PIN METAL BUSH REMOVAL/ INSTALLATION KIT USA PAT. 卡車彈簧鋼拆裝工具組	HEAVY DUTY U-JOINT PULLER 卡車U形球頭拆卸器
H.C.B-F1181 P138	H.C.B-A2019 P146
TRUCK SPRING PIN METAL BUSH REMOVAL / INSTALLATION TOOL KIT (17 TONS HYDRAULIC CYLINDER) 卡車彈簧鋼拆裝工具組(17噸油壓式)	3 TONS FOUR WHEELS HYDRAULIC FLOOR JACK 3噸油壓四輪千斤頂
H.C.B-A1183 P139	H.C.B-A2045 P146
TRUCK THREAD CORRECTOR 卡車可換式螺紋修正器	1.5 TONS TRUCK TRANSMISSION JACK 1.5 噸卡車變速箱千斤頂
H.C.B-A1895 P139	H.C.B-A2102 P147
TRUCK THREAD CORRECTOR 卡車可換式螺紋修正器	HYDRAULIC WHEEL DOLLY 大車輪胎搬運車
H.C.B-A1665 P140	H.C.B-B2102 P147
UNIVERSAL HYDRAULIC PRESSURE KIT 通用油壓組	HYDRAULIC WHEEL DOLLY 大車輪胎搬運車
H.C.B-A1690 P140	H.C.B-B2115 P148
UNIVERSAL TRUCK BUSH REPLACEMENT TOOL KIT (W/18 TONS HYDRAULIC) 萬用卡車鐵套更換工具組 (18噸油壓缸)	BLIND HOLE BEARING PULLER 隱蔽型培林拆卸器
H.C.B-A1256 P140	H.C.B-A1015 P148
PITMAN ARM PULLER (32mm) 大車橫拉桿球頭拆卸器(32mm)	BLIND HOLE BEARING PULLER 隱蔽型培林拆卸器
H.C.B-A1222 P141	H.C.B-A1435 P149
UNIVERSAL CRANKSHAFT PULLEY EXTRACTOR 萬用卡車曲軸皮帶盤拆卸器	KENWORTH TRUCK REAR AXLE NUT SOCKET (SW 4", 6 POINTS, Dr.3/4") KENWORTH 卡車後輪軸螺帽套筒 (SW 4", 6角, Dr.3/4")
H.C.B-A1279 P141	H.C.B-B1655 P149
UNIVERSAL AXLE NUT REMOVAL/ INSTALLATION TOOL KIT 萬用型輪軸螺帽拆裝組	UNIVERSAL BEARING EXTRACTOR 萬用培林拆卸器
H.C.B-B1391 P142	H.C.B-A2165 P150
UNIVERSAL TRUCK WHEEL HUB EXTRACTOR 萬用卡車輪軸HUB拆卸器	HYDRAULIC BEARING PULLER (8 TONS) 油壓式培林拔輪器(8噸)
H.C.B-C1391 P142	H.C.B-B2165 P150
UNIVERSAL TRUCK WHEEL HUB EXTRACTOR 萬用卡車輪軸HUB拆卸器	HYDRAULIC BEARING PULLER (8 TONS) 油壓式培林拔輪器(8噸)
H.C.B-A1383 P143	
ELECTRICAL BRAKE LINING SHOE LOADER PAT.409117 電動鑄釘機	

H.C.B-C2165 P150 HYDRAULIC BEARING PULLER (12 TONS) 油壓式培林拔輪器(12噸)	H.C.B-A2226 P157 JACK STAND (18") 貨車頂車架(18")
H.C.B-D2165 P150 HYDRAULIC BEARING PULLER (4 TONS) 油壓式培林拔輪器(4噸)	H.C.B-B2226 P157 JACK STAND (24") 貨車頂車架(24")
H.C.B-E2165 P150 HYDRAULIC BEARING PULLER (12 TONS) 油壓式培林拔輪器(12噸)	H.C.B-C2226 P157 JACK STAND (28") 貨車頂車架(28")
H.C.B-B2126 P151 20 TONS AIR HYDRAULIC BOTTLE JACK 20噸氣動油壓千斤頂	H.C.B-A2009 P158 CLUTCH ALIGNMENT TOOL (IRON) 離合器對孔校正器(鐵)
H.C.B-B2127 P151 30 TONS AIR HYDRAULIC BOTTLE JACK 30噸氣動油壓千斤頂	H.C.B-A2021 P158 SOCKET TOOL KIT (34PCS) 星型中空,E型綜合套筒組(34PC)
H.C.B-A2146 P151 PNEUMATIC GREASE PUMP (20 L) 氣動黃油機 (20升)	H.C.B-A2022 P158 18 PCS IMPACT HEXAGON & TX-STAR WRENCH KIT 6角,星型凸套筒組(18PC)
H.C.B-A2160 P152 WASTE OIL DRAINER (80 L) 廢油桶(80升)	H.C.B-A2086 P159 160 PCS COMPREHENSIVE TOOL KIT 160 PCS 專業級套筒組
H.C.B-B2160 P152 WASTE OIL DRAINER (MANUAL) (50 L) 手動升降式牛油機(50升)	H.C.B-A2145 P159 94 PCS (Dr.1/4" & 1/2") TOOL KIT 94 PCS (Dr.1/4" & 1/2") 套筒組
H.C.B-A2203 P153 PNEUMATIC FLUID EXTRACTOR (8.5L) 氣動抽油機(8.5L)	H.C.B-A2166 P160 16 PCS (Dr. 3/4" & 1") SQ. DRIVE INSERT BIT SOCKET KIT 16PCS 套筒組 (Dr. 3/4" & 1")
H.C.B-A2204 P153 PNEUMATIC OIL & LIQUID DISPENSER (6000 c.c.) 吸排兩用液體分裝機(6000c.c.)	H.C.B-A2168 P160 9 PCS STAR-E SOCKET KIT (E10/E11/E12/E14/E16/E18/E20/E22/E24) 9PCS E型套筒組(E10/E11/E12/E14/E16/E18/E20/E22/E24)
H.C.B-A2205 P154 BASIC BRAKE OIL EXTRACTOR (2000 c.c.) 專業剎車油吸取機(2000c.c.)	H.C.B-A2209 P160 DIESEL INJECTOR SEAT CUTTER KIT 柴油噴油嘴座清除器
H.C.B-A2206 P154 BRAKE OIL FILLER (1000 c.c.) 剎車油補充油瓶(1000c.c.)	H.C.B-A2107 P161 EXTRA LONG OFFSET BOX WRENCH KIT (8 PCS) 加長型梅花扳手組(8PCS)
H.C.B-A1065 P155 WAGON SUPPORTER 貨車專用安全頂架(配合平板頂車機使用)	H.C.B-B2107 P161 EXTRA LONG OFFSET BOX WRENCH KIT (6 PCS) (10 x 12, 12 x14, 13 x 15,16 x 18,17 x 19, 22 x 24 mm) 加長平型梅花扳手組 (6 PCS) (10 x 12, 12 x14, 13 x 15,16 x 18,17 x 19, 22 x 24 mm)
H.C.B-A2147 P155 GREASE FILLER FOR PAIL(20L) 鋁合金手壓式培林注油機(20升)	H.C.B-A2177 P161 5 PCS HALF-MOON RING WRENCH 5 PCS 扳手 (半月型)
H.C.B-A2148 P155 TRACK BEARING PACKER (FOR TRUCK) 鋁合金氣壓式培林注油機	H.C.B-C1641 P162 UNIVERSAL LOCKING RING TOOL PAT. 萬能扣環鉗
H.C.B-A2157 P156 TRUCK JACK STAND 15,000 LBS 卡車千斤頂 15,000磅	H.C.B-B1641 P162 UNIVERSAL LOCKING RING TOOL PAT. D178574 萬能扣環鉗
H.C.B-A2158 P156 TRUCK JACK STAND 15,000 LBS 卡車千斤頂 15,000磅	H.C.B-A2170 P163 DIESEL ENGINE COMPRESSION TESTER KIT 柴油引擎汽缸壓力測試工具組
H.C.B-B2158 P157 TRUCK JACK STAND 33,000 LBS 卡車千斤頂 33,000磅	H.C.B-B2192 P163 OIL DRAIN REPAIR KIT 油底殼螺絲更換組
	H.C.B-A1320 P164 SPECIAL SOCKET FOR TRUCK (Dr. 3/4", 6 POINTS) 卡車特殊套筒(Dr. 3/4", 6角)

H.C.B-B1320 P164	H.C.B-M1337 P170
SPECIAL SOCKET FOR TRUCK (Dr. 1", 6 POINTS) 卡車特殊套筒 (Dr. 1", 6 角)	ISUZU (CXZ 10PE1) TRUCK ENGINE FIXING BASE (ACCESSORY) ISUZU (CXZ 10PE1) 卡車引擎固定座 (配件)
H.C.B-B1320-7090 P165	H.C.B-D1339 P171
SPECIAL SOCKET FOR TRUCK (Dr.1", 70 mm, L: 90mm) 卡車特殊套筒 (Dr.1", 70 mm, 長度: 90mm)	TRUCK KING PIN PRESS (75 TONS) DE. PAT.M459081 大王銷拆卸機(75噸)
H.C.B-A1488 P165	H.C.B-C1339 P171
SPECIAL SOCKET FOR TRUCK (Dr. 3/4", 8 POINTS) 卡車輪軸螺帽套筒 (Dr. 3/4", 8 角)	TRUCK KING PIN PRESS (75 TONS) DE. PAT.M459081 大王銷拆卸機 (75噸)
H.C.B-B1488 P165	H.C.B-A1339 P172
SPECIAL SOCKET FOR TRUCK (Dr. 1", 8 POINTS) 卡車輪軸螺帽套筒 (Dr. 1", 8 角)	TRUCK KING PIN PRESS (30 TONS) DE. PAT.M459081 大王銷拆卸機(30噸)
H.C.B-A1592 P166	H.C.B-A2050 P172
SPECIAL SOCKET FOR TRUCK (Dr. 1", 12 POINTS, L: 90mm) 卡車特殊套筒 (Dr. 1", 12 角, L: 90mm)	CAST STEEL SWIVEL-BASE VISE (6") 老虎鉗 (6")
H.C.B-A1336 P166	H.C.B-A2050-1 P172
MANUAL LINING PULLER KIT 手動汽缸套拔卸組	CAST STEEL SWIVEL-BASE VISE (8") 老虎鉗 (8")
H.C.B-A1337 P167	H.C.B-A2050-2 P172
TRUCK K/D RACK - MANUAL PAT.I 380921 手動卡車多功能拆裝架	CAST STEEL SWIVEL-BASE VISE (10") 老虎鉗 (10")
H.C.B-B1337 P167	H.C.B-B2050 P172
TRUCK K/D RACK - ELECTRICAL PAT.I 380921 電動卡車多功能拆裝架	CAST IRON VISE (6") 老虎鉗 (6")
H.C.B-C1337 P168	H.C.B-A2094 P173
TRANSMISSION FIXED BASE 卡車變速箱固定座	TWO WAY OIL FILTER WRENCH (60~80mm) 二爪正反轉機油芯扳手(60~80mm)
H.C.B-D1337 P168	H.C.B-B2094 P173
DIFFERENTIAL FIXING BASE 卡車差速器固定座	TWO WAY OIL FILTER WRENCH (80~110mm) 二爪正反轉機油芯扳手(80~110mm)
H.C.B-E1337 P168	H.C.B-D2094 P173
CUMMINS (EURO 4) / DAF (LF 65) 17 TONS ENGINE FIXING BASE 康明斯 (四期環保) / DAF (LF 65) 17噸 引擎固定架	TWO WAY OIL FILTER WRENCH (104~150mm) 二爪正反轉機油芯扳手(104~150mm)
H.C.B-F1337 P168	H.C.B-B2121 P174
ISUZU (MYY 5T) TRUCK TRANSMISSION FIXING BASE (ACCESSORY) ISUZU (MYY 5T) 卡車變速箱固定座 (配件)	PORTABLE POWER STATION (FOR SEDAN) 電霸(汽油車·柴車用)
H.C.B-G1337 P169	H.C.B-C2121 P174
ISUZU (4JJ1 & 4HK1) TRUCK ENGINE FIXING BASE (ACCESSORY) ISUZU (4JJ1 & 4HK1) 卡車引擎固定架 (配件)	PORTABLE POWER STATION (230V/50Hz) 電霸(230V/50HZ)
H.C.B-H1337 P169	H.C.B-D2121 P174
ISUZU (6HK1) TRUCK ENGINE FIXING BASE (ACCESSORY) ISUZU (6HK1) 卡車引擎固定架 (配件)	PORTABLE POWER STATION (VEHICLE) 電霸(電力士)
H.C.B-I1337 P169	H.C.B-A1502 P175
ISUZU (MZW 6P) TRUCK TRANSMISSION FIXING BASE (ACCESSORY) ISUZU (MZW 6P) 卡車變速箱固定架 (配件)	20 TONS AIR/HYDRAULIC FLOOR JACK - LOW PROFILE 20 噸 氣油/油壓千斤頂
H.C.B-J1337 P169	H.C.B-A1855 P175
HINO (JO8C) 17 TONS TRUCK ENGINE FIXING BASE (ACCESSORY) HINO (JO8C) 17 噸卡車引擎固定架 (配件)	SITRAK TRUCK DRIVE AXLE NUT SOCKET(DR.3/4",H60,6TEETH) 賽德卡卡車帶動軸螺帽套筒(DR.3/4",H60,6齒)
H.C.B-K1337 P170	H.C.B-A6001 P175
ISUZU (6WG1/6WF1)TRUCK ENGINE FIXING BASE (ACCESSORY) ISUZU (6WG1/6WF1)卡車引擎固定架 (配件)	HYDRAULIC ELEVATOR CART (300 KGS) 油壓升降推車(300 公斤)
H.C.B-L1337 P170	H.C.B-A2061 P176
ISUZU TRUCK FVR DIFFERENTIAL FIXING BASE ISUZU卡車FVR差速器固定架	HEIGHTENED MANUAL HYDRAULIC PRESS (15 TONS) 加高型手動油壓床 (15噸)

H.C.B-A2197 P176	H.C.B-C1481 P183
HEAVY DUTY OIL FILTER CHAIN WRENCH (350mm) 鏈條式機油濾芯扳手 (350mm)	DAF/MAN/SCANIA REMOVAL TOOL FOR AIR DRYER FILTER (Dr. 1/2") (125-140mm) DAF/MAN/SCANIA 四向闊乾燥濾芯扳手(Dr. 1/2") (125-140mm)
H.C.B-B2197 P176	H.C.B-D1481 P183
HEAVY DUTY OIL FILTER CHAIN WRENCH (520mm) 鏈條式機油濾芯扳手 (520mm)	SCANIA REMOVAL TOOL FOR FUEL FILTER (Dr. 1/2") (70-80mm) SCANIA柴油濾芯扳手(Dr. 1/2") (70- 80mm)
H.C.B-A2128 P177	H.C.B-E1481 P183
AIR HOSE REEL (10 METERS) 捲式風管(10米)	TRUCK REMOVAL TOOL FOR FUEL FILTER/ OIL FILTER (80-90mm) 卡車柴油/機油濾芯扳手(80-90mm)
H.C.B-B2128 P177	H.C.B-F1481 P183
CORD REEL 捲式三插座	EUROPEAN/ JAPANESE TRUCK REMOVAL TOOL FOR FUEL FILTER/ OIL FILTER (90-100mm) 歐/日系卡車柴油/機油濾芯扳手(90-100mm)
H.C.B-C2128 P177	H.C.B-A1560 P184
CORD REEL+110V WORK LIGHT 捲式三插座+日光燈(110V)	SCANIA 113 (320) TRUCK FRONT WHEEL AXLE BEARING PULLER SCANIA 113 (320) 卡車前輪軸培林拔卸器
H.C.B-D2128 P178	H.C.B-B1560 P184
WATER HOSE REEL (8 METERS) 水管捲揚器(8米)	TRUCK FRONT WHEEL AXLE BEARING PULLER (JAPANESE TRUCK) 卡車前輪軸培林拔卸器 (日系車種)
H.C.B-A1412 P178	H.C.B-D1560 P184
TRUCK RADIATOR PRESSURE TEST KIT (9 PCS) 卡車水箱測漏組(9PCS)	TRUCK REAR WHEEL AXLE BEARING PULLER (JAPANESE TRUCK) 卡車後輪軸培林拔卸器 (日系車種)
H.C.B-A3005 P179	H.C.B-C1560 P185
10 TONS TWO SPEEDS DYNAMIC POWER KIT 10噸雙段油壓鉗金組	TRUCK FRONT WHEEL AXLE BEARING PULLER TOOL (SCANIA/JAPANESE TRUCK) 卡車前輪軸培林拔卸器 (SCANIA/日系車種)
H.C.B-A1538 P179	H.C.B-A1853 P185
EXTRA LONG HEXAGON IMPACT WHEEL NUTS SOCKET (Dr.3/4", 24/27/30/32/33/36 mm, L: 400 mm) 氣動長套筒 (Dr.3/4", 24/27/30/32/33/36 mm, L:400 mm)	HEAVY DUTY GEARBOX BEARING PULLER PAT. M574100 重型變速箱培林拔卸器
H.C.B-A1497 P179	H.C.B-E1560 P186
ALUM-A-STACK HYDRAULIC RAM KIT 卡車堆疊式油壓組	SCANIA (113/114),MAN (410/414) TRUCK DIFFERENTIAL BEARING EXTRACTOR SCANIA (113/114),MAN (410/414) 卡車差速器培林拆卸器
New H.C.B-A1543 P180	H.C.B-G1560 P186
COMMINS TIMING TOOLS 康明斯正時工具組	FUSO (330) TRUCK DIFFERENTIAL MAIN SHAFT BEARING EXTRACTOR FUSO (330)卡車差速器主軸培林拆卸器
New H.C.B-A1937 P180	H.C.B-A2280 P186
HYDRAULIC CYLINDER 油壓鋼	UNIVERSAL JOINT (Dr.1") 1"萬向轉接頭
New H.C.B-A1936 P181	H.C.B-A2282 P187
HYDRAULIC CYLINDER 油壓鋼	TRUCK BRAKE SPOONS(2 PCS) 卡車剎車調整扳手(2 PCS)
New H.C.B-A1935 P181	New H.C.B-A1893 P187
HOLLOW PLUNGER CYLINDER 中空油壓鋼	SITRAK OIL SEAL REMOVER 賽德卡油封拆卸工具
H.C.B-B1502 P182	New H.C.B-A1894 P187
20 TONS AIR/HYDRAULIC TRUCK JACK-LOW TYPE 20噸 氣動/油壓千斤頂	SITRAK OIL SEAL INSTALLER 賽德卡油封安裝工具
H.C.B-C1502 P182	H.C.B-A2258 P188
50 TONS AIR/HYDRAULIC JACK 50噸 氣動/油壓千斤頂	TOE JACK L 型油壓千斤頂
H.C.B-A1481 P183	H.C.B-A2273 P188
VOLVO /HINO REMOVAL TOOL FOR OIL FILTER (Dr. 1/2") (100-110mm) VOLVO /HINO 機油芯/油水分離器濾芯扳手 (Dr.1/2") (100-110mm)	TRUCK CLUTCH AND FLYWHEEL JACK -LOW CLEARANCE 卡車離合器/飛輪千斤頂
H.C.B-B1481 P183	
FUSO (10.5-17 TONS) REMOVAL TOOL FOR OIL FILTER (Dr.1/2") (110-125mm) FUSO (10.5-17噸) 機油濾芯/油水分離器濾芯扳手 (Dr.1/2") (110-125mm)	

H.C.B-A2281 P189	New H.C.B-A2334 P195
Dr.3/4" IMPACT SOCKET SET (17 PCS) (19/21/22/24/27/30/32/33/34/35/36/38/40/41/46/50/55 mm) Dr.3/4" 氣動套筒組 (17 PCS) (19/21/22/24/27/30/32/33/34/35/36/38/40/41/46/50/55 mm)	PROFESSIONAL EXTENDABLE HANDLE RATCHET WRENCH (72 TEETH) 72齒免撥伸縮葫蘆柄扳手
H.C.B-C2297 P189	New H.C.B-B2334 P195
DIESEL/PETROL FUEL SYRINGE (1.5 L) 柴/汽油真空抽取注射器 (1.5 升)	PROFESSIONAL EXTENDABLE HANDLE RATCHET WRENCH (60 TEETH) 60齒免撥伸縮葫蘆柄扳手
H.C.B-A2299 P189	New H.C.B-A2336 P196
3 FUNCTION TIRE PRESSURE GAUGE (FOR TRUCK) 三用胎壓量錶(卡車)	1/2" F X 3/4" M 1500 NM TORQUE MULTIPLIER KIT (7 PCS) 1500 NM 9倍倍力器組 (7 PCS)
H.C.B-A2300 P190	New H.C.B-B2336 P196
FLEXIBLE CROW'S FOOT SOCKET WRENCH SET (12 PCS) 搖頭鴨掌扳手組 (12 PCS)	3/4" F X 1" M 2500 NM TORQUE MULTIPLIER KIT (7 PCS) 2500 NM 4倍倍力器組 (7 PCS)
H.C.B-A2301 P190	New H.C.B-A2333 P197
75° BOX END & FLEXIBLE GEAR RATCHET WRENCH WITH GO-THROUGH SOCKET SET (17 PCS) 穿透式套筒組 (17 PCS)	TRUCK CLUTCH ALIGNER TOOL (6 PCS) 卡車離合器校正工具 (6 PCS)
H.C.B-A2302 P191	New H.C.B-A2340 P197
DOUBLE FLEXIBLE RATCHET FLARE NUT WRENCH (10x12/ 13x14/ 15x17 mm) (3 PCS) 雙搖頭開口油管扳手 (10x12/ 13x14/ 15x17 mm) (3 PCS)	6 TONS JACK STANDS 6噸頂車架
New H.C.B-A2348 P191	New H.C.B-A2341 P197
Dr. 3/4" TORQUE WRENCH (140~760N.M / 100~560 FT-LB) 扭力扳手 (Dr.3/4", 140~760N.M)	2.5 TONS HYDRAULIC TROLLEY JACK 2.5噸油壓千斤頂
H.C.B-A2306 P192	New H.C.B-A2342 P198
Dr.3/4" TORQUE WRENCH (200-1000N.M) Dr.3/4" 扭力扳手 (200-1000牛噸米)	2 TONS HYDRAULIC FLOOR JACK 2噸油壓千斤頂
H.C.B-A2307 P192	New H.C.B-A2343 P198
RATCHET EXHAUST PIPE CUTTER 排氣管切管器	2 TONS ALUMINUM RACING JACK 2噸鋁合金千斤頂
H.C.B-A2309 P192	New H.C.B-A2344 P198
3L TRUCK/ TRAILER WHEEL AXLE OIL DRAIN 3L卡車/拖車輪軸油盤	2.5 TONS HYDRAULIC TROLLEY JACK 2.5噸油壓千斤頂
H.C.B-A2310 P193	New H.C.B-A2355 P199
OIL DRAIN PAN 油盤	TRUCK TRANSMISSION JACK 卡車變速箱千斤頂 (負載: 1000 KGS)
New H.C.B-A1767 P193	New H.C.B-A2337 P199
AIR TUBING ADAPTOR CLAMP 風管管束鉗	WHEEL NUT TWIST SOCKET KIT (4 PCS) 破壞型螺旋套筒及延伸桿(4 PCS)
New H.C.B-B1767 P193	
AIR TUBING ADAPTOR INSTALLATION TOOL KIT 風管接頭安裝工具組	
New H.C.B-A1837 P194	
GENERAL ENGINE MAINTENANCE HANDLING TOOL 通用引擎維修搬運工具	
New H.C.B-C1475 P194	
HIGH PRESSURE FUEL LINE SOCKET (Dr. 3/8" x 19 mm x 78 mm L) 高壓油管套筒 (Dr. 3/8" x 19 mm x 78 mm L)	
New H.C.B-D1475 P194	
HIGH PRESSURE FUEL LINE SOCKET (Dr. 3/8" x 21 mm x 78 mm L) 高壓油管套筒 (Dr. 3/8" x 21 mm x 78 mm L)	
New H.C.B-A1851 P195	
SOCKET DISPLAY STAND 套筒展示架	

氣動工具
Air Power Tools

H.C.B-B2005 P201	H.C.B-A3036 P205
1/2" AIR IMPACT WRENCH 1/2" 氣動扳手(下排式)	AIR HYDRAULIC PUMP (1600 c.c.) (3/8" ADAPTER) 氣動幫浦 (1600 c.c.)(3/8" 接頭)
H.C.B-B2005-1 P201	H.C.B-B3036 P205
1/2" AIR IMPACT WRENCH (WITH 10 PCS SOCKET) 1/2" 氣動扳手(下排式,含套筒)	AIR HYDRAULIC PUMP (1800 c.c.) 氣動幫浦 (1800 c.c.)
H.C.B-B2025 P201	H.C.B-C3036 P205
3/8" AIR MINI RATCHET WRENCH 3分氣動棘輪扳手	DOUBLE HOSE AIR HYDRAULIC PUMP (3800c.c.) 雙管幫浦 (3800 c.c.)
H.C.B-A2034 P201	H.C.B-D3036 P206
1/4" 90° AIR STUBBY AIR RATCHET WRENCH 1/4" 90° 氣動扳手	AIR/ HYDRAULIC PUMP (7600 c.c.) 氣動/油壓幫浦 (7600 c.c.)
H.C.B-A2046 P202	H.C.B-E3036 P206
1/2" 90° STUBBY AIR RATCHET WRENCH 1/2" 90° 氣動扳手	AIR/ HYDRAULIC FOOT PUMP (2000 c.c.) 氣動/油壓幫浦 (2000 c.c.)
H.C.B-A2047 P202	H.C.B-F3036 P206
AIR DIE GRINDER 氣動刻模機	AIR/HYDRAULIC PUMP (WITHOUT HOSE)6.2-6.8 BAR AIR PRESSURE / PUMP230-245 BAR 氣動/油壓幫浦(不含管)
H.C.B-A2048 P202	H.C.B-G3036 P207
16 PCS AIR DIE GRINDER KIT 氣動刻模機組(16 PCS)	HIGH PRESSURE MANOMETER (15,000 PSI) 高壓力錶 (15,000 PSI)
H.C.B-A2139 P202	New H.C.B-A2350 P207
1/2" MINI IMPACT WRENCH 1/2" 輕型氣動扳手	GEARLESS ANGLE IMPACT WRENCH (3/8") 氣動彎頭衝擊扳手(無齒輪) (3/8")
H.C.B-A2173 P203	New H.C.B-B2350 P207
1/2" 90° AIR RATCHET WRENCH 1/2" 90° 氣動棘輪扳手	GEARLESS ANGLE IMPACT WRENCH (1/2") 氣動彎頭衝擊扳手(無齒輪) (1/2")
H.C.B-A2200 P203	H.C.B-A2269 P208
3/4" IMPACT WRENCH 3/4" 氣動扳手	1" SQ DR. HEAVY DUTY IMPACT WRENCH 1" 氣動扳手
H.C.B-B2200 P203	H.C.B-A2270 P208
3/4" ALUMINUM HOUSING IMPACT WRENCH 3/4" 鋁合金氣動扳手	1" SQ DR. EXTRA HEAVY DUTY IMPACT WRENCH, LONG ANVIL 1" 長軸氣動扳手
H.C.B-A2285 P203	
1/2" MINI COMPOSITE IMPACT WRENCH (JAMBO HAMMER) 4分塑膠手柄迷你單環式捶打式衝擊扳手	
H.C.B-A2286 P204	
1/2" COMPOSITE IMPACT WRENCH (TWIN HAMMER) 4分塑膠手柄雙環式捶打式衝擊扳手	
H.C.B-B2286 P204	
3/8" COMPOSITE IMPACT WRENCH (TWIN HAMMER) 475 NM 3分塑膠手柄雙捶打式衝擊扳手 (扭力475牛頓米)	
H.C.B-A2287 P204	
3/4" COMPOSITE IMPACT WRENCH (TWIN HAMMER) 6分塑膠手柄雙環捶打式衝擊扳手	
H.C.B-A2326 P204	
10.8 V CORDLESS IMPACT WRENCH (Dr.3/8") 10.8 V 充電式衝擊扳手 (3/8")	

一般修護工具修護設備
General Repair Equipment































H.C.B-A1073	P210	H.C.B-A1051-4	P215
3 - SHELF SERVICE CART (STAINLESS)		PUNCHED BOARD (561mm x 866mm x 20mm)	
三層不銹鋼工具車		洞洞板(561mm x 866mm x 20mm)	
H.C.B-C1076	P210	H.C.B-C1051	P216
11 - DRAWER ROLLER CABINET		TOOL CABINET	
11抽工具車		壁櫃	
H.C.B-A1135-R	P210	H.C.B-D1051	P217
THE COMPACT TOOLBOX TROLLEY (RED)		TOOL CABINET	
美式工具車		工具櫃	
H.C.B-A1541	P211	H.C.B-A2283	P217
DIGITAL CALIPER		Dr.1/2" DEEP IMPACT SOCKET KIT (13 PCS)	
極速卡尺		(10/11/12/13/14/16/17/19/21/22/24/27/30mm)	
H.C.B-A2001	P211	Dr.1/2" 長型氣動套筒組	
3 - SHELF SERVICE CART		(13 PCS) (10/11/12/13/14/16/17/19/21/22/24/27/30mm)	
3層工具車		H.C.B-A2230	P217
H.C.B-A2010	P211	Dr. 3/4" TX-STAR & SPLINE IMPACT BIT SOCKET KIT (6 PCS)	
FOUR - SHELF CART		Dr. 3/4" 氣動星形12角凸型套筒組 (6 PCS)	
工具車(4層開放式附間隔塊)		H.C.B-B2230	P217
H.C.B-A2011	P212	3/4" SQ. DRIVE HEXAGON & SPLINE IMPACT BIT SOCKET KIT	
TOOL BOX, 6 DRAWERS (MODEL 300)		(9PCS) (61mm) (14/17/19/21/22/23/24mm/M16/M18)	
6抽工具車(300型)		Dr. 3/4" 氣動6角&12角套筒組	
H.C.B-F2060	P212	(9 PCS) (61mm) (14/17/19/21/22/23/24mm/M16/M18)	
3 - DRAWER DOUBLE SIDED TROLLEY		H.C.B-C2230	P218
3抽雙開工具車		3/4" SQ. DRIVE HEXAGON & TX-STAR IMPACT BIT SOCKET KIT (9PCS)	
H.C.B-A2060	P213	(61mm) (19/21/22/23/24mm/T70/80/90/100)	
TOOL BOX, 7 DRAWERS ROLLER CART (BALL BEARING SLIDE)		Dr. 3/4" 氣動星形12角凸型套筒組 (9 PCS) (61mm)	
7抽工具車		(19/21/22/23/24mm/T70/80/90/100)	
H.C.B-B2060	P213	H.C.B-B2138	P218
WALL CABINET (W:660mmx D:305mmx H:600mm)		WORKING TABLE (CABINET)	
工具壁櫃(寬:660mmx深:305mmx高:600mm)		美式工作桌(加壁櫃)	
H.C.B-C2060	P213	H.C.B-B2138-1	P218
TOP TRAY		FIXED HOOK	
上方膠盤		壁櫃掛勾	
H.C.B-D2060	P213	H.C.B-A2316	P218
(18") SIDE PANEL		MECHANICS CREEPER	
(18") 側板		臥板	
H.C.B-E2060	P214	H.C.B-A2317	P219
14 DRAWER ROLLER TOOL CABINETS		THREADED COIL-INSERT REPAIR KIT (130 PCS)	
14抽滾輪工具櫃		螺紋修護組(130 PCS)	
H.C.B-A1051-1	P214	H.C.B-A2319	P219
PUNCHED BOARD (885mm x 870mm)		2 WAY AIR DUSTER	
洞洞板(3尺 X 3尺)		二用風槍	
H.C.B-A1051-2	P214	H.C.B-A2322	P219
PUNCHED BOARD (L:1800mm x W:865mm x H:20mm)		SPARK PLUG PLIERS (3 PCS)	
洞洞板(長1800mm x 寬865mm x 高20mm)		火星塞鉗 (3 PCS)	
H.C.B-A1051-3	P215	H.C.B-A6005-5	P220
3" FIXED HOOK		TOOL HOLDER(5 SLICES)	
3"洞洞勾		工具櫃(五片)	
		H.C.B-A6006	P220
		MAGNETIC STAND W/GAUGE	
		磁性座含錶	













H.C.B-IV1001	P088	H.C.B-A1050-3.....	P017	H.C.B-F1090	P004
H.C.B-IV1002	P088	H.C.B-B1050-3.....	P017	H.C.B-G1090	P004
H.C.B-IV1003	P089	H.C.B-A1050-4.....	P018	H.C.B-B1091	P004
H.C.B-IV1004	P089	H.C.B-B1050-5.....	P002	H.C.B-C1091	P004
H.C.B-IV1006	P090	H.C.B-A1050-6.....	P018	H.C.B-A1102	P130
H.C.B-IV1008	P090	H.C.B-B1050-6.....	P018	H.C.B-B1102	P027
H.C.B-IV1009	P090	H.C.B-C1050-6.....	P018	H.C.B-C1102	P108
H.C.B-IV1010	P091	H.C.B-D1050-6.....	P019	H.C.B-A1112	P131
H.C.B-IV1011	P091	H.C.B-B1050-7.....	P002	H.C.B-A1120	P134
H.C.B-IV1012	P091	H.C.B-A1050-8.....	P002	H.C.B-A1120-308.....	P135
H.C.B-IV1013	P092	H.C.B-A1051-1.....	P214	H.C.B-A1120-309.....	P135
H.C.B-IV1014	P092	H.C.B-A1051-2.....	P214	H.C.B-A1120-310.....	P135
H.C.B-IV1015.....	P092	H.C.B-A1051-3.....	P215	H.C.B-B1120	P136
H.C.B-IV1016.....	P093	H.C.B-A1051-4.....	P215	H.C.B-B1120-A.....	P136
H.C.B-IV1017.....	P093	H.C.B-C1051.....	P216	H.C.B-B1120-B.....	P136
H.C.B-IV1018.....	P093	H.C.B-D1051.....	P217	H.C.B-B1120-C.....	P136
H.C.B-IV1019.....	P094	H.C.B-A1054-2.....	P143	H.C.B-A1122	P105
H.C.B-IV1020.....	P094	H.C.B-A1054-4.....	P143	H.C.B-A1125	P005
H.C.B-IV1021.....	P094	H.C.B-B1056	P105	H.C.B-B1125	P005
H.C.B-IV1022.....	P095	H.C.B-B1059	P117	H.C.B-C1125.....	P005
H.C.B-IV1023.....	P095	H.C.B-A1065	P155	H.C.B-A1126.....	P005
H.C.B-IV1024.....	P095	H.C.B-A1066-1.....	P020	H.C.B-B1126.....	P006
H.C.B-IV1025.....	P095	H.C.B-A1066-2.....	P019	H.C.B-C1126.....	P006
H.C.B-IV1026.....	P096	H.C.B-A1066-3-1	P019	H.C.B-A1127.....	P100
H.C.B-IV1027.....	P096	H.C.B-A1066-3-2.....	P019	H.C.B-A1135-R.....	P210
H.C.B-IV1028.....	P096	H.C.B-A1066-5.....	P107	H.C.B-A1165.....	P131
H.C.B-IV1029.....	P097	H.C.B-A1071	P021	H.C.B-A1167.....	P006
H.C.B-IV1030.....	P097	H.C.B-A1073	P210	H.C.B-F1168.....	P145
H.C.B-IV1031.....	P097	H.C.B-A1075	P021	H.C.B-A1169.....	P027
H.C.B-IV1032.....	P098	H.C.B-B1075	P022	H.C.B-A1170.....	P111
H.C.B-IV1033.....	P098	H.C.B-C1076	P210	H.C.B-A1171.....	P020
H.C.B-A1009	P131	H.C.B-A1082-1.....	P132	H.C.B-B1171.....	P020
H.C.B-A1015	P148	H.C.B-A1090	P002	H.C.B-C1171.....	P021
H.C.B-B1050-1.....	P002	H.C.B-B1090	P003	H.C.B-A1172.....	P022
H.C.B-A1050-2.....	P017	H.C.B-C1090	P003	H.C.B-B1172.....	P022
H.C.B-B1050-2.....	P017	H.C.B-D1090	P003	H.C.B-A1175.....	P029
		H.C.B-E1090	P003	H.C.B-B1175.....	P028

H.C.B-C1175.....	P029	H.C.B-A1242.....	P063	H.C.B-A1286.....	P105
H.C.B-A1176.....	P028	H.C.B-A1244.....	P054	H.C.B-A1287.....	P143
H.C.B-A1177.....	P080	H.C.B-A1246.....	P031	H.C.B-A1314.....	P063
H.C.B-A1178.....	P101	H.C.B-A1247.....	P031	H.C.B-B1314.....	P064
H.C.B-B1178.....	P101	H.C.B-A1248.....	P103	H.C.B-A1319.....	P009
H.C.B-C1178.....	P102	H.C.B-A1256.....	P140	H.C.B-A1320.....	P164
H.C.B-A1179.....	P109	H.C.B-A1257.....	P007	H.C.B-B1320.....	P164
H.C.B-A1180.....	P109	H.C.B-A1261.....	P106	 H.C.B-B1320-052.....	P042
H.C.B-A1181.....	P009	H.C.B-B1261.....	P106	H.C.B-B1320-7090.....	P165
H.C.B-B1181.....	P109	H.C.B-A1263.....	P063	H.C.B-A1328.....	P024
H.C.B-C1181.....	P137	H.C.B-A1265.....	P008	H.C.B-A1329.....	P024
H.C.B-D1181.....	P137	H.C.B-B1265.....	P008	 H.C.B-B1329.....	P025
H.C.B-E1181.....	P138	H.C.B-A1269.....	P031	H.C.B-A1335.....	P032
H.C.B-F1181.....	P138	H.C.B-A1270.....	P103	H.C.B-A1336.....	P166
H.C.B-B1182.....	P132	H.C.B-A1271.....	P055	H.C.B-A1337.....	P167
H.C.B-A1183.....	P139	H.C.B-A1271-A.....	P055	H.C.B-B1337.....	P167
H.C.B-A1184.....	P100	H.C.B-A1271-B.....	P055	H.C.B-C1337.....	P168
H.C.B-B1184.....	P100	H.C.B-A1271-C.....	P055	H.C.B-D1337.....	P168
H.C.B-C1184.....	P101	H.C.B-A1271-D.....	P055	H.C.B-E1337.....	P168
H.C.B-A1186.....	P029	H.C.B-A1271-E.....	P055	H.C.B-F1337.....	P168
H.C.B-B1186.....	P030	H.C.B-A1271-F.....	P055	H.C.B-G1337.....	P169
H.C.B-A1187.....	P137	H.C.B-A1271-G.....	P055	H.C.B-H1337.....	P169
H.C.B-A1190.....	P051	H.C.B-A1271-H.....	P055	H.C.B-I1337.....	P169
H.C.B-A1191.....	P135	H.C.B-B1271.....	P056	H.C.B-J1337.....	P169
H.C.B-A1203.....	P023	H.C.B-C1271.....	P056	H.C.B-K1337.....	P170
H.C.B-A1210.....	P103	H.C.B-A1273.....	P023	 H.C.B-L1337.....	P170
H.C.B-A1222.....	P141	H.C.B-A1274.....	P023	 H.C.B-M1337.....	P170
H.C.B-A1225.....	P134	H.C.B-A1275.....	P104	H.C.B-A1338.....	P110
H.C.B-A1226.....	P134	 H.C.B-B1275.....	P104	H.C.B-A1339.....	P172
H.C.B-A1227.....	P006	H.C.B-B1277.....	P008	H.C.B-C1339.....	P171
H.C.B-A1228.....	P021	H.C.B-A1278.....	P007	 H.C.B-D1339.....	P171
H.C.B-A1229.....	P030	H.C.B-A1279.....	P141	H.C.B-A1344.....	P025
H.C.B-A1236.....	P007	H.C.B-A1280.....	P069	H.C.B-A1345.....	P025
H.C.B-A1238.....	P030	H.C.B-A1281.....	P014	H.C.B-A1350.....	P010
H.C.B-B1238.....	P030	H.C.B-A1282.....	P070	H.C.B-B1350.....	P032
H.C.B-A1239.....	P024	H.C.B-A1283.....	P070	 H.C.B-B1350-H.....	P032
H.C.B-B1239.....	P024	H.C.B-A1284.....	P009	H.C.B-A1351.....	P107

H.C.B-B1351.....P107	H.C.B-A1432.....P057	H.C.B-A1494.....P076
H.C.B-A1353.....P013	H.C.B-A1434.....P072	H.C.B-A1495-1.....P112
H.C.B-B1353.....P013	H.C.B-A1435.....P149	H.C.B-A1495-2.....P112
 H.C.B-C1353.....P013	H.C.B-A1439.....P110	H.C.B-A1497.....P179
H.C.B-A1363.....P032	H.C.B-A1441.....P065	H.C.B-A1502.....P175
H.C.B-A1380.....P033	H.C.B-A1442.....P065	H.C.B-B1502.....P182
H.C.B-A1383.....P143	H.C.B-A1443.....P065	H.C.B-C1502.....P182
H.C.B-A1384.....P064	H.C.B-A1444.....P014	H.C.B-A1520.....P114
H.C.B-A1387.....P066	H.C.B-A1448.....P075	H.C.B-A1521.....P051
H.C.B-B1387.....P066	H.C.B-A1454.....P050	H.C.B-A1538.....P179
H.C.B-C1387.....P066	H.C.B-A1462.....P035	H.C.B-A1541.....P211
H.C.B-A1390.....P072	H.C.B-A1465.....P053	 H.C.B-A1543.....P180
H.C.B-B1391.....P142	H.C.B-B1465.....P053	H.C.B-A1557-50.....P076
H.C.B-C1391.....P142	H.C.B-A1466.....P075	H.C.B-A1557-90.....P077
H.C.B-D1391.....P016	H.C.B-A1472.....P110	H.C.B-A1560.....P184
H.C.B-E1391.....P016	 H.C.B-C1475.....P194	H.C.B-B1560.....P184
H.C.B-A1393.....P034	 H.C.B-D1475.....P194	H.C.B-C1560.....P185
H.C.B-B1393.....P034	H.C.B-A1478.....P016	H.C.B-D1560.....P184
H.C.B-C1393.....P035	H.C.B-A1481.....P183	H.C.B-E1560.....P186
H.C.B-A1397.....P108	H.C.B-B1481.....P183	H.C.B-F1560.....P036
H.C.B-A1398.....P054	H.C.B-C1481.....P183	H.C.B-G1560.....P186
H.C.B-A1402.....P033	H.C.B-D1481.....P183	H.C.B-H1560.....P036
H.C.B-B1402.....P011	H.C.B-E1481.....P183	H.C.B-A1561.....P068
H.C.B-C1402.....P062	H.C.B-F1481.....P183	H.C.B-A1562.....P062
H.C.B-A1403.....P072	H.C.B-A1482.....P074	H.C.B-A1569.....P083
H.C.B-A1404.....P073	H.C.B-A1483.....P074	H.C.B-A1572.....P057
H.C.B-A1407.....P130	H.C.B-A1488.....P165	H.C.B-A1579.....P115
H.C.B-A1409.....P059	H.C.B-B1488.....P165	H.C.B-B1579.....P115
H.C.B-A1410.....P132	H.C.B-B1488-120.....P073	H.C.B-C1579.....P116
H.C.B-C1410.....P133	H.C.B-A1490.....P015	 H.C.B-D1579.....P116
H.C.B-A1411-95.....P067	H.C.B-B1490.....P015	H.C.B-A1581.....P079
H.C.B-A1411-98.....P067	H.C.B-C1490.....P015	H.C.B-A1582.....P079
H.C.B-A1412.....P178	H.C.B-A1491.....P113	H.C.B-A1586.....P116
H.C.BA1415.....P112	H.C.B-B1491.....P113	H.C.B-A1592.....P166
H.C.B-B1415.....P112	H.C.B-C1491.....P113	H.C.B-A1600.....P081
H.C.B-A1422.....P069	H.C.B-A1492.....P075	H.C.B-A1601.....P067
H.C.B-A1423.....P037	H.C.B-A1493.....P076	H.C.B-A1602.....P058

H.C.B-B1602.....P058	H.C.B-A1675.....P080	New H.C.B-A1773.....P081
H.C.B-A1603.....P068	New H.C.B-B1675.....P043	New H.C.B-B1773.....P081
H.C.B-A1606.....P010	H.C.B-A1676.....P088	New H.C.B-A1788.....P082
H.C.B-B1606.....P010	H.C.B-B1676.....P089	New H.C.B-A1789.....P082
New H.C.B-C1606.....P011	H.C.B-A1677.....P040	New H.C.B-A1791.....P125
H.C.B-A1608.....P037	H.C.B-A1678.....P060	New H.C.B-A1792.....P125
H.C.B-A1609.....P036	H.C.B-A1679.....P060	New H.C.B-A1793.....P126
H.C.B-A1610.....P080	H.C.B-A1681.....P119	New H.C.B-A1794.....P084
H.C.B-A1614.....P037	New H.C.B-C1681.....P119	New H.C.B-A1797.....P084
H.C.B-A1615.....P038	H.C.B-A1682.....P061	New H.C.B-A1799.....P044
H.C.B-A1616.....P038	H.C.B-A1683.....P102	New H.C.B-A1800.....P043
H.C.B-A1617.....P038	H.C.B-A1685.....P061	New H.C.B-A1801.....P044
H.C.B-A1618.....P069	H.C.B-B1685.....P061	New H.C.B-A1802.....P044
H.C.B-A1625.....P117	H.C.B-C1685.....P061	New H.C.B-A1803.....P045
H.C.B-A1626.....P039	H.C.B-A1690.....P140	New H.C.B-A1804.....P045
H.C.B-A1627.....P039	H.C.B-A1691.....P102	New H.C.B-A1805.....P045
H.C.B-B1627.....P039	H.C.B-A1693.....P040	New H.C.B-A1806.....P045
H.C.B-C1627.....P039	H.C.B-B1693.....P041	New H.C.B-A1807.....P046
H.C.B-A1628.....P114	H.C.B-C1693.....P041	New H.C.B-A1808.....P046
H.C.B-A1630.....P012	New H.C.B-D1693.....P041	New H.C.B-A1810.....P046
H.C.B-A1634.....P069	H.C.B-A1695.....P033	New H.C.B-A1814.....P127
H.C.B-A1635.....P117	H.C.B-A1697.....P041	New H.C.B-A1823.....P047
H.C.B-A1636.....P059	H.C.B-A1698.....P042	New H.C.B-A1824.....P047
H.C.B-B1636.....P060	H.C.B-A1701.....P012	New H.C.B-A1825.....P047
New H.C.B-B1641.....P162	H.C.B-A1707.....P042	New H.C.B-A1826.....P047
New H.C.B-C1641.....P162	H.C.B-A1709.....P078	New H.C.B-A1827.....P048
H.C.B-A1646.....P040	H.C.B-A1716.....P054	New H.C.B-A1828.....P048
H.C.B-A1654.....P040	H.C.B-A1718.....P057	New H.C.B-A1829.....P048
H.C.B-B1655.....P149	H.C.B-A1726.....P118	New H.C.B-A1830.....P049
H.C.B-A1661.....P078	H.C.B-B1726.....P118	New H.C.B-A1831.....P049
H.C.B-A1663.....P053	H.C.B-A1730.....P012	New H.C.B-A1832.....P064
H.C.B-B1663.....P051	H.C.B-A1736.....P079	New H.C.B-A1833.....P049
H.C.B-C1663.....P052	H.C.B-A1740.....P068	New H.C.B-A1836.....P085
H.C.B-A1665.....P140	New H.C.B-A1753.....P062	New H.C.B-A1837.....P194
H.C.B-A1667.....P077	New H.C.B-A1767.....P193	New H.C.B-A1838.....P050
H.C.B-A1669.....P082	New H.C.B-B1767.....P193	New H.C.B-B1838.....P050
H.C.B-A1673.....P118	New H.C.B-A1771.....P043	New H.C.B-A1845.....P085

 H.C.B-A1849.....P106	H.C.B-A2018-5.....P120	H.C.B-A2060.....P213
 H.C.B-A1850P145	H.C.B-A2018-11.....P120	H.C.B-B2060.....P213
 H.C.B-A1851.....P195	H.C.B-A2018-12P121	H.C.B-C2060.....P213
 H.C.B-A1853.....P185	H.C.B-A2018-13P121	H.C.B-D2060.....P213
 H.C.B-A1855.....P175	H.C.B-A2018-14P121	H.C.B-E2060.....P214
 H.C.B-A1868.....P075	H.C.B-A2018-17P121	H.C.B-F2060.....P212
 H.C.B-A1871-60P078	H.C.B-A2018-18P122	H.C.B-A2061.....P176
 H.C.B-A1871-90P078	H.C.B-A2018-19.....P028	H.C.B-A2086.....P159
 H.C.B-A1893.....P187	H.C.B-A2018-20P122	H.C.B-A2094P173
 H.C.B-A1894.....P187	H.C.B-A2018-21P122	H.C.B-B2094.....P173
 H.C.B-A1895.....P139	H.C.B-A2018-22P123	H.C.B-D2094.....P173
 H.C.B-A1910.....P029	H.C.B-A2018-23P123	H.C.B-A2101.....P144
 H.C.B-A1915.....P098	H.C.B-A2018-24P123	H.C.B-A2102P147
 H.C.B-A1922.....P074	H.C.B-A2018-25P123	H.C.B-B2102P147
 H.C.B-A1923.....P086	H.C.B-A2018-26P077	H.C.B-A2107.....P161
 H.C.B-A1924.....P085	H.C.B-A2018-27P144	H.C.B-B2107.....P161
 H.C.B-A1931.....P084	H.C.B-A2018-28P124	H.C.B-B2115P148
 H.C.B-A1932.....P127	H.C.B-A2018-29P124	H.C.B-B2121.....P174
 H.C.B-A1933.....P127	H.C.B-A2018-30P124	H.C.B-C2121.....P174
 H.C.B-A1934.....P128	 H.C.B-A2018-31P125	H.C.B-D2121.....P174
 H.C.B-A1935.....P181	 H.C.B-A2018-33P126	H.C.B-B2126.....P151
 H.C.B-A1936.....P181	 H.C.B-A2018-34P126	H.C.B-B2127.....P151
 H.C.B-A1937.....P180	 H.C.B-A2018-36P126	H.C.B-A2128.....P177
 H.C.B-A1947.....P085	 H.C.B-A2018-37P127	H.C.B-B2128P177
 H.C.B-A1948.....P086	H.C.B-A2019.....P146	H.C.B-C2128.....P177
 H.C.B-A1964.....P128	H.C.B-A2021.....P158	H.C.B-D2128.....P178
H.C.B-A2001.....P211	H.C.B-A2022.....P158	H.C.B-A2130.....P125
H.C.B-B2005.....P201	H.C.B-B2025.....P201	H.C.B-A2132.....P026
H.C.B-B2005-1.....P201	H.C.B-A2034.....P201	H.C.B-B2132.....P026
H.C.B-A2009.....P158	H.C.B-A2045.....P146	H.C.B-C2132.....P026
H.C.B-A2010.....P211	H.C.B-A2046.....P202	H.C.B-B2138.....P218
H.C.B-A2011.....P212	H.C.B-A2047.....P202	H.C.B-B2138-1.....P218
H.C.B-A2013.....P144	H.C.B-A2048.....P202	H.C.B-A2139.....P202
H.C.B-A2018P119	H.C.B-A2050.....P172	H.C.B-A2145.....P159
H.C.B-A2018-1.....P120	H.C.B-A2050-1.....P172	H.C.B-A2146.....P151
H.C.B-A2018-2.....P120	H.C.B-A2050-2.....P172	H.C.B-A2147.....P155
H.C.B-A2018-3.....P033	H.C.B-B2050.....P172	H.C.B-A2148.....P155

H.C.B-A2157.....P156	H.C.B-A2269.....P208	 H.C.B-A2344.....P198
H.C.B-A2158.....P156	H.C.B-A2270.....P208	 H.C.B-A2348.....P191
H.C.B-B2158.....P157	H.C.B-A2273.....P188	 H.C.B-A2350.....P207
H.C.B-A2160.....P152	H.C.B-A2280.....P186	 H.C.B-B2350.....P207
H.C.B-B2160.....P152	H.C.B-A2281.....P189	 H.C.B-A2355.....P199
H.C.B-A2165.....P150	H.C.B-A2282.....P187	H.C.B-A3005.....P179
H.C.B-B2165.....P150	H.C.B-A2283.....P217	H.C.B-A3036.....P205
H.C.B-C2165.....P150	H.C.B-A2285.....P203	H.C.B-B3036.....P205
H.C.B-D2165.....P150	H.C.B-A2286.....P204	H.C.B-C3036.....P205
H.C.B-E2165.....P150	H.C.B-B2286.....P204	H.C.B-D3036.....P206
H.C.B-A2166.....P160	H.C.B-A2287.....P204	H.C.B-E3036.....P206
H.C.B-A2168.....P160	H.C.B-C2297.....P189	H.C.B-F3036.....P206
H.C.B-A2170.....P163	H.C.B-A2299.....P189	H.C.B-G3036.....P207
H.C.B-A2173.....P203	H.C.B-A2300.....P190	H.C.B-A6001.....P175
H.C.B-A2177.....P161	H.C.B-A2301.....P190	H.C.B-A6005-5.....P220
H.C.B-A2178.....P070	H.C.B-A2302.....P191	H.C.B-A6006.....P220
H.C.B-B2192.....P163	H.C.B-A2306.....P192	
H.C.B-A2193.....P014	H.C.B-A2307.....P192	
H.C.B-A2197.....P176	H.C.B-A2309.....P192	
H.C.B-B2197.....P176	H.C.B-A2310.....P193	
H.C.B-A2200.....P203	H.C.B-A2313.....P114	
H.C.B-B2200.....P203	H.C.B-B2313.....P115	
H.C.B-A2203.....P153	H.C.B-A2316.....P218	
H.C.B-A2204.....P153	H.C.B-A2317.....P219	
H.C.B-A2205.....P154	H.C.B-A2319.....P219	
H.C.B-A2206.....P154	H.C.B-A2322.....P219	
H.C.B-A2209.....P160	H.C.B-A2326.....P204	
H.C.B-A2212.....P071	 H.C.B-A2333.....P197	
H.C.B-A2222.....P071	 H.C.B-A2334.....P195	
H.C.B-A2226.....P157	 H.C.B-B2334.....P195	
H.C.B-B2226.....P157	 H.C.B-A2336.....P196	
H.C.B-C2226.....P157	 H.C.B-B2336.....P196	
H.C.B-A2228.....P012	 H.C.B-A2337.....P199	
H.C.B-A2230.....P217	 H.C.B-A2340.....P197	
H.C.B-B2230.....P217	 H.C.B-A2341.....P197	
H.C.B-C2230.....P218	 H.C.B-A2342.....P198	
H.C.B-A2258.....P188	 H.C.B-A2343.....P198	



SINCE 1990

HWANG CHERNG BIN
Specialty Tools Inc.

歐系卡車修護工具

EUROPEAN TRUCK REPAIR TOOL



H.C.B-B1050-1

SCANIA FRONT WHEEL SHOCK ABSORBER SPRING WASHER SOCKET (Dr. 3/4")

SCANIA 前輪避震器彈簧墊片拆裝套筒 (Dr. 3/4")
30 / 13.8 / 14.8 / 0.9'

ON TRUCK

H.C.B-B1050-5

SCANIA REAR AXLES DAMPER ROD SOCKET (Dr. 3/4")

SCANIA 後輪避震器彈簧墊片拆裝套筒 (Dr. 3/4")
30 / 20 / 21 / 1'

H.C.B-B1050-7

SCANIA REAR WHEEL SHOCK ABSORBER SPRING WASHER SOCKET (Dr. 3/4")

SCANIA 後輪避震器彈簧墊片拆裝套筒 (Dr. 3/4")
30 / 23.2 / 24.2 / 1'



PART SIZE

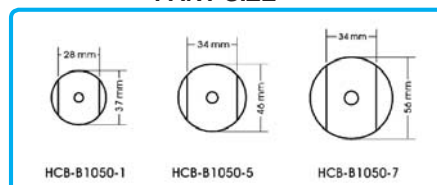

可在車上拆裝 SCANIA 卡車避震器簧墊片

H.C.B-A1050-8

SCANIA 10 WHEELS CAB THIRD AXLE NUT SOCKET (Dr. 3/4", 8 POINTS, 95 mm)

SCANIA 10 輪拖車頭第三軸螺帽套筒
(Dr. 3/4" · 8 角 · 95 mm)

10 / 25.5 / 26.5 / 0.72'



- Application: SCANIA trailer, YORK haulage, FUSO 10.5 tons truck
- 適用車種：SCANIA 拖車, YORK 板車, FUSO 10.5 噸卡車



FUSO ORIGINAL PARTS
NO.: MC870996
FUSO 零件編號：MC870996

YORK



H.C.B-A1090

SCANIA TRUCK (310/320/340) TRANSMISSION SOCKET (Dr. 3/4")

SCANIA 卡車 (310/320/340) 變速箱專用套筒 (Dr. 3/4")

12 / 14.7 / 15.7 / 1.53'

- Used for Scania transmission flange shaft on transmission and rear axle.
- Application: SCANIA310(112)/320(113)/340(114)Rear spindle (8/10 speed)
- 適用車種：SCANIA 310(112)/320(113)/340(114) 後主軸 (8/10 速)
- 原廠編號：98285

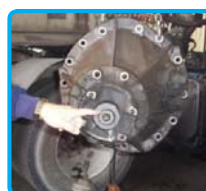

NUT SIZE

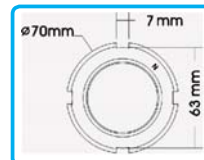

NUT SIZE

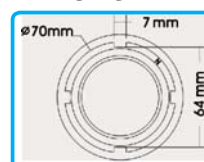

H.C.B-B1090

SCANIA TRANSMISSION CLUTCH FRONT MAIN SHAFT SOCKET (Dr. 3/4")

SCANIA 變速箱離合器前主軸螺帽套筒 (Dr. 3/4")

12 / 17.5 / 18.5 / 1.53'

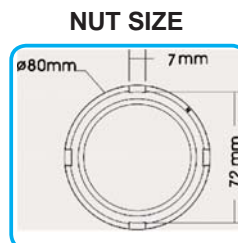
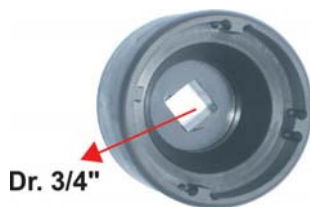

H.C.B-C1090

SCANIA 8-SPEED BUS TRANSMISSION NUT SOCKET (Dr. 3/4")

SCANIA 變速箱螺帽拆裝套筒 (遊覽車 8 速) (Dr. 3/4")

12 / 22.5 / 23.5 / 1.53'

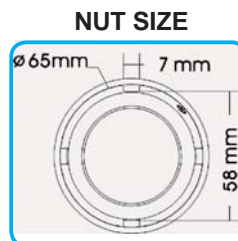

H.C.B-D1090

SCANIA TRANSMISSION CLUTCH FRONT MAIN AXLE NUT SOCKET (Dr. 3/4")

SCANIA 變速箱離合器前主軸螺帽套筒 (Dr. 3/4")

12 / 13.3 / 14.3 / 1.53'

- For extracting / installing the front main axle of transmission clutch nut on SCANIA truck with ten speeds automatic transmission.
- 可拆裝 SCANIA 10 速自動變速箱前主軸離合器的螺帽

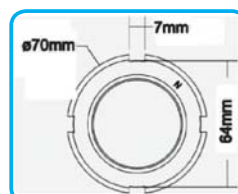

H.C.B-E1090

SCANIA PTO NUT SOCKET (Dr. 1/2")

SCANIA 卡車 PTO 螺帽拆裝套筒 (Dr. 1/2")

20 / 18 / 19 / 0.5'

- For removing / replacing the SCANIA hauler tractor truck PTO nut, also for third axle hanger nut on the trailer.
- 可移除、更換 SCANIA 拖車頭的 PTO 螺帽及拖車第三軸的懸掛螺帽。

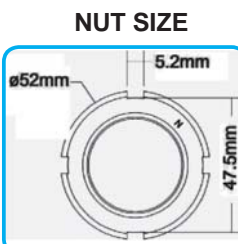

H.C.B-F1090

SCANIA (340) TRANSMISSION CLUTCH FRONT MAIN SHAFT SOCKET (Dr. 3/4")

SCANIA (340) 變速箱離合器前主軸螺帽套筒 (Dr. 3/4")

- For extracting/installing the front main shaft of transmission clutch nut on SCANIA (340) truck
- Application : SCANIA(340) Truck.
- 可拆裝 SCANIA 340 自動變速箱前主軸離合器的螺帽。
- 適用車種 : SCANIA(340) 卡車



H.C.B-G1090

SCANIA DIFFERENTIAL REAR AXLE NUT SOCKET (Dr. 3/4")

SCANIA 差速器後輪軸螺母套筒 (Dr. 3/4")

- For removing/installing differential rear pinion nut.
- Genuine stock : 1338267
- Application : SCANIA (3-series) differential gear rear nut. EX:RB660,RB662,RBP735/835...
- 拆除 / 安裝差速器後輪軸螺母。
- 螺母原廠料號 : 1338267
- 適用車種 : SCANIA(3 系列) 差速器後輪軸螺母 · EX:RB660,RB662,RBP735/835...



Genuine no.
of tool : 98480

H.C.B-B1091

SCANIA TRUCK FRONT WHEEL AXLES HUB EXTRACTOR

SCANIA 卡車前輪仰角 HUB 拆卸器

- When SCANIA axle bearing is stuck due to it's overheating, use H.C.B-B1091 with air wrench for labor saver and easier removal.
- 當 SCANIA 卡車輪軸軸承過熱咬死，使用此工具搭配氣動扳手拆卸，變得更輕鬆、容易。

※ 使用工具前，請放鬆手煞車

Caution: Before demolish the screws, you should loosen the wheel brakes first to keep it idle.



H.C.B-C1091

SCANIA TRUCK FRONT WHEEL AXLES HUB EXTRACTOR (W/HYDRAULIC CYLINDER)

SCANIA 卡車前輪仰角 HUB 拆卸器 (油壓式)

- The tool can be easily operated if combine with H.C.B-B1129 (Hydraulic Hand Pump) which can save time and increase working efficiency while SCANIA axle bearing gets stuck due to overheating.
- SCANIA 卡車輪軸軸承過熱咬死，使用此工具搭配 H.C.B-B1129 (油壓幫浦) 使用，既省力又方便有效率，是您賺錢的最佳利器。

※ 使用工具前，請放鬆手煞車

Caution: Before demolish the screws, you should loosen the wheel brakes first to keep it idle.



H.C.B-A1125

SCANIA FRONT WHEEL NUT SOCKET (H41, 8 POINTS, 80 mm)

SCANIA 前輪螺帽拆裝套筒 (H41 · 8 角 · 80 mm)

12 / 21.2 / 23.3 / 0.84'

Size: H41, 8 points, 80 mm
Application: SCANIA
適用車種: SCANIA



Step 1: Extract the front axle plastic cover by H.C.B-A1167 socket. (6 points, 27 mm) (Only for SCANIA 340)

步驟 1: 先用 H.C.B-A1167(6 角 · 27mm 套筒) 移除前輪軸上的塑膠蓋。(本步驟只用於 SCANIA 340)

H.C.B-B1125

SCANIA FRONT WHEEL NUT SOCKET (Dr. 3/4", 8 POINTS, 80 mm)

SCANIA 前輪螺帽拆裝套筒 (Dr. 3/4" · 8 角 · 80 mm)

12 / 21 / 22 / 0.74'



Step 2: Remove the front wheel nut with this tool.

步驟 2: 用本工具轉開前輪螺帽

H.C.B-C1125

SCANIA FRONT WHEEL NUT SOCKET (Dr. 1", 8 POINTS, 80 mm)

SCANIA 前輪螺帽拆裝套筒 (Dr. 1" · 8 角 · 80 mm)

12 / 21.5 / 22 / 0.93'



H.C.B-A1126

SCANIA REAR WHEEL NUT SOCKET (8 POINTS, 100 mm)

SCANIA 後輪螺帽拆裝套筒 (8 角, 100 mm)

4 / 24 / 26 / 2.45'

- Fix bearing while removing or installing the truck nut.
- Control the nut with slide rod to adjust bearing.
- 拆卸、安裝卡車螺帽時，用來固定培林
- 配合扳手使用，來進行拆裝



H.C.B-B1126

SCANIA REAR WHEEL NUT SOCKET (Dr. 3/4", 8 POINTS, 100 mm)

SCANIA 後輪螺帽拆裝套筒 (Dr. 3/4", 8 角, 100 mm)

8 / 20.9 / 22 / 0.88"

- Control the nut with slide rod to adjust bearing.
- 配合扳手使用，來進行拆裝

Dr. 3/4"



H.C.B-C1126

SCANIA REAR WHEEL SOCKET (Dr. 1", 8 POINTS, 100 mm)

SCANIA 後輪螺帽拆裝套筒 (Dr. 1" · 8 角 · 100 mm)

8 / 22 / 22.5 / 0.74"

Dr. 1"



H.C.B-A1167

SCANIA, BENZ (W203 / W209) WRENCH SOCKET (FLUID RESERVOIR ON CONDENSER) (Dr. 1/2", 27 mm)

SCANIA, BENZ (W203 / W209)
冷凝器貯油槽套筒扳手 (Dr. 1/2", 27 mm)

- For screw plug removal and installation on fluid reservoir on condenser.
- Also used for SCANIA front wheel plastic cover.
- Application: BENZ (W203/W209) & SCANIA truck
- Genuine Stock No.: 203 589 00 10 00

- 用來拆裝冷凝器貯油槽的套筒
- 也可用在 SCANIA 前輪塑膠蓋
- 適用車種: BENZ (W203/W209), SCANIA
- 原廠料號: 203 589 00 10 00



SCANIA(P340)



BENZ(W203)



H.C.B-A1227

SCANIA TRUCK FLYWHEEL ROTATOR (Dr. 1/2")

SCANIA 卡車曲軸飛輪轉動器 (Dr. 1/2")

- The tool is designed to rotate the crankshaft for engine timing.
- Application: SCANIA Truck
- 使用 1/2" 扳桿轉動齒輪，以供正時使用
- 適用車種: SCANIA 卡車

Dr. 1/2"



H.C.B-A1236

SCANIA (320/340/360) KING PIN EXTRACTOR (10 WHEELS)

SCANIA (320/340/360) 大王銷拆卸器 (10 輪)

- For removing the SCANIA(320/340/360) king pin.
- 可用來拆卸 SCANIA(320/340/360) 的大王銷，請配合氣動扳手使用。



Optional: A1236-7
(選購)

- This socket must to be used with H.C.B-A1236.
- Application: VOLVO (FM12) (380/420P)



H.C.B-A1257

SCANIA (340) ELECTROMAGNETIC INJECTION VALVE CAP SOCKET (Dr. 1/2" , 8 POINTS, 38 mm)

SCANIA (340) 電磁閥噴油嘴蓋套筒 (Dr. 1/2" , 8 角 , 38 mm)

- For tightening & loosening the electromagnetic injection valve cap.
- Application: SCANIA (340) trailer
- 可用來旋緊和鬆開電磁閥的噴油嘴蓋。
- 適用車種：SCANIA 340 拖車

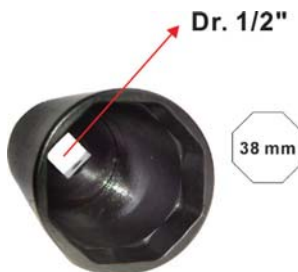

Scania Genuine Stock No.:
1529752 8075
119966 0332 5
106 868
USA

H.C.B-A1278

SCANIA (420) AXLE HUB NUT SOCKET (Dr. 3/4" , 8 TEETH)

SCANIA (420) 輪軸螺帽套筒 (Dr. 3/4" , 8 齒)

8 / 22.5 / 23 / 0.69'

- Fix bearing while removing or installing the truck nut.
- Application: SCANIA 420
- 拆卸安裝卡車螺帽時，用來固定培林
- 適用車種：SCANIA 420



H.C.B-A1265

SCANIA (320/340) / VOLVO (FM12) PITMAN ARM PULLER (Dr. 3/4" , 58 mm)

SCANIA (320/340) / VOLVO (FM12) 方向機搖臂拆卸器 (Dr. 3/4" , 58 mm)

Bolt Size: TM42 x P3.0

4 / 24.5 / 25 / 1.64'

- Used on the pitman arm of European trucks. No need to destroy the pitman arm.
- Application: European truck. Such as SCANIA, VOLVO(FM12).
- Loosen the fixed nut on the arm before using H.C.B-A1265.
- 用於歐系卡車的方向機搖臂上，不需要破壞方向機搖臂。
- 適用車種：歐系卡車。如：SCANIA . VOLVO FM12。
- 使用 H.C.B-A1265 之前，要先鬆開方向機搖臂的上固定螺帽。



H.C.B-B1265

SCANIA (320/340)/ VOLVO (FM12) PITMAN ARM PULLER (58 mm) (W/ HYDRAULIC CYLINDER)

SCANIA (320/340) / VOLVO (FM12) 方向機搖臂拆卸器 (58 mm) (油壓式)

- Used on the pitman arm of European trucks. No need to destroy the pitman arm.
- Designed to combine with hydraulic pump.
- Application: European truck. Such as SCANIA, VOLVO (FM12).
- Loosen the fixed nut on the arm before using H.C.B-B1265.
- Thread-outside dimension of cylinder : Ø50 x 16UNF
- 用於歐系卡車的方向機搖臂上，不需要破壞方向機搖臂。
- 可搭配油壓幫浦使用。(H.C.B-B1129) 省力好用
- 適用車種：歐系卡車。如：SCANIA.VOLVO FM12。
- 使用 H.C.B-B1265 之前，要先鬆開方向機搖臂的上固定螺帽。
- 油壓缸外牙尺寸：Ø 50 x 16UNF



H.C.B-B1277

SCANIA (320/340) / VOLVO(FM12)/ MAN(FE414) STEERING MECHANISM BEARING PULLER

SCANIA (320/340) / VOLVO (FM12) / MAN (FE414)
方向機培林拆卸組

- Designed to remove the bearing of steering mechanism and replace oil seal.
- Application: SCANIA 320 (113)/340 (114), MAN (FE414) (Genuine no. of bearing 10-8325)VOLVO(FM12)
- 依照 SCANIA 車種挑選適合配件，拆下培林以方便更換油封。
- 適用車種：SCANIA 320(113)/340(114) · MAN(FE414) (培林料號：10-8325) VOLVO(FM12)



SCANIA 320 Bearing



H.C.B-A1284

SCANIA TRANSMISSION REAR OIL SEAL INSTALLER

SCANIA 變速箱後油封安裝器

- The seals are on the shaft that control the direction. They are different from the ones on gear box and axle gear.
- Strictly prohibited to drive the seal and thrust piece back by hammer or drill.
- Genuine stick of oil seal: 1 502 384, 1 502 385
- 油封位於旋轉方向的軸上，和位於齒輪箱及齒輪軸上的不同。
- 嚴禁使用榔頭把油封推到定點。
- 油封料號：1 502 384 · 1 502 385

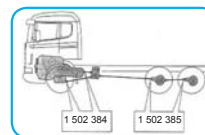

Press seal onto thrust piece by H.C.B-A1284.
Then press thrust piece and seal onto shaft.
用 H.C.B-A1284 將油封壓回推動件中，再將推動件和油封壓回軸中。

H.C.B-A1181

SCANIA & VOLVO SPRING PIN METAL BUSH REMOVAL / INSTALLATION TOOL KIT (W/ HYDRAULIC CYLINDER)

SCANIA & VOLVO 卡車彈簧銷拆裝工具組 (油壓式)

1 / 11.5 / 12 / 0.86'

- Parts no. 4,5,6 and 7 are changeable to fit most kinds of SCANIA & VOLVO trucks.
- Allow easier replacement of spring pin .Save money and labor.
- Optional: H.C.B-B1129 HYDRAULIC HAND PUMP
- Application: The length of brass bush under 120 mm
- 第 4、5、6、7 號的零件可替換。請挑選適合的尺寸，以用於 SCANIA 和 VOLVO 卡車。
- 可輕鬆地更換彈簧銷，省錢又省力。
- 選購配備：H.C.B-B1129 手搖幫浦
- 適用範圍：長度在 120mm 以下的黃銅套。

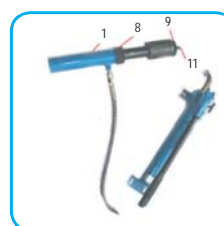

BRASS BUSH
APPLICABLE:
SCANIA & VOLVO TRUCK



H.C.B-A1319

SCANIA (310/320) CRANKSHAFT REAR OIL SEAL INSTALLER

SCANIA (310/320) 曲軸後油封安裝器

- Put new oil seal onto crankshaft. (Fig. 1)
- Put H.C.B-A1319 above the oil seal and hit it. To force oil seal install to the right place. (Fig. 2)
- Application: SCANIA 310(112)/320(113)
- Oil seal no.: 0366303-R
- 放置新油封到曲軸上。(Fig. 1)
- 把 H.C.B-A1319 放到油封上，藉由搥打工具將油封安裝到正確的位置。(Fig. 2)
- 適用車種：SCANIA 310(112)/320(113)
- 油封料號：0366303-R



Oil Seal No.
0366303-R



Fig.1



Fig.2

H.C.B-A1350

SCANIA RADIATOR ADAPTOR

SCANIA 水箱快速接頭

- Female adaptor for radiator when draining or refilling radiator liquid.
- Application: SCANIA 340/360 truck and bus.
- 用於排出或灌注水箱水的快速接頭。
- 適用車種：SCANIA 340/360 卡車和巴士



VIDEO



H.C.B-A1606

SCANIA 340/380 (EURO 4) CRANKSHAFT FRONT/ REAR OIL SEAL INSTALLER (PR SERIES)

SCANIA 340/380 (四期環保車) 曲軸前後油封安裝工具組 (PR 系列)

- Description: When installing the oil seal, you won't damage the oil seal. With this tool kit will make repair more convenient and easier.
- Application: SCANIA 340/380 (PR Series)
- Oil seal genuine no.: 143 31 83
- 使用說明：此工具在安裝油封的過程中，不會損壞到油封，並且更快速、簡便。
- 適用車種：SCANIA 340/380 (PR 系列)
- 油封料號：143 31 83



VIDEO



Screw the nut until finish installing.



Finish installing.

H.C.B-B1606

SCANIA (114) 340/360/380 CRANKSHAFT FRONT OIL SEAL INSTALLER

SCANIA(114) 340/360/380 曲軸前油封安裝工具

- This tool is designed to install crankshaft front oil seal. It can install the oil seal without damage the oil seal and related parts.
- Oil seal OEM no: 1392708
- Application: SCANIA (114) 340/360/380 truck. (Before year 2010)
- 此工具為安裝曲軸前油封。在安裝油封過程快速、準確，不會損壞到油封及零件。
- 油封料號：1392708
- 適用車種：SCANIA(114) 340/360/380 卡車 (2010 年前)

VIDEO



Oil seal:1392708



H.C.B-C1606

NEW

SCANIA (114) 340/ 360/ 380 CRANKSHAFT FRONT OIL SEAL INSTALLER(AFTER 2010)

SCANIA (114) 340/ 360/ 380 曲軸前油封安裝工具 (2010 年以後)

- This tool is designed to install crankshaft front oil seal without damaging the oil seal and related parts.
- Application: P340/P380 (Series 4), P400/P440/P480 (Series 5), after year 2010
- Oil seal OEM no.: 1754911
- Oil seal size: 140x160x12 mm

- 此工具為安裝曲軸前油封。在安裝油封過程快速、準確，不會損壞到油封及零件。
- 適用車種：P340/P380(4 期) · P400/P440/P480(5 期) · 2010 年以後
- 油封料號：1754911
- 油封尺寸：140x160x12 mm

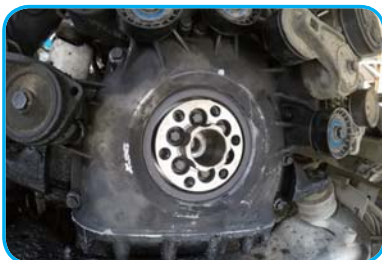
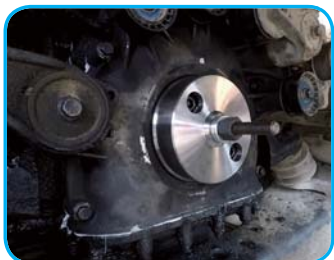

H.C.B-B1402

SCANIA (340/360/380) VALVE SPRING COMPRESSOR TOOL KIT

SCANIA (340/360/380) 汽門彈簧壓縮工具組

- Feature: It won't need to remove the cylinder when you replace oil seal. It will save you 7~8 hours when you work.
- Application: SCANIA (340/360/380) truck
- The size for the screw: M10 x P1.5, L: 25 mm
- 說明：此工具讓你在更換油封時，免拆卸氣缸蓋，可節省 7~8 小時的時間，並能輕鬆移除及安裝 SCANIA (340/360/380) 汽門彈簧油封。
- 適用車種：SCANIA (340/360/380) 卡車
- 螺絲尺寸：M10 x P1.5, L: 25 mm

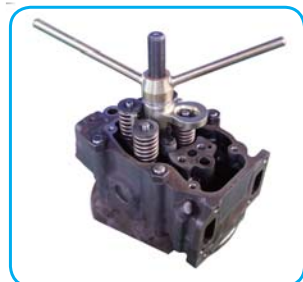

H.C.B-A1630

SCANIA (114) INJECTOR REMOVAL/ INSTALLATION TOOL KIT

SCANIA (114) 噴油嘴拆裝工具組

- This tool has the single hook design. When removing the injector, only one hook is required. Use the slide hammer to remove the injector without damaging the injector or relative parts. It is a saving-time and saving-labor tool.
- Application: SCANIA (114) 340.360.380
- 此工具之爪鉤為單邊設計。拆卸時只需單邊勾住噴油嘴，之後利用滑鏈即可將其取出。過程中不會損害噴油嘴及相關零件，快速又方便。
- 適用車種：SCANIA (114) 340.360.380



H.C.B-A2228

SCANIA SOCKET (Dr. 3/4", 90 mm) (E28)

SCANIA 套筒 (Dr. 3/4", 90 mm) (E28)

- To remove / install the bolt of crankshaft main bearing cap.
- Application: SCANIA Ti engine.
- 可拆裝曲軸主培林蓋上的螺絲。
- 適用車種：SCANIA Ti 引擎



H.C.B-A1701

SCANIA TRUCK INJECTOR ADJUSTOR

SCANIA 卡車噴油嘴調整器

- For setting PDE unit injectors
- SCANIA OEM no. ref.: 99414
- 用來調整噴油嘴
- 原廠料號：99414

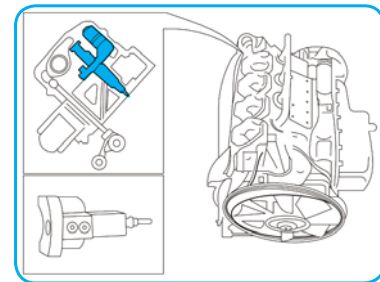

H.C.B-A1730

SCANIA 114 (340/ 360/ 380) TRUCK PISTON RING INSTALLATION SLEEVE

SCANIA 114 (340/ 360/ 380) 卡車活塞安裝工具

- Please lubricate the tool before installation.
- Special design of cone tool make piston ring into cylinder sleeve easily, save time and labor!
- Used to guide the piston into the cylinder sleeve during piston installation.
- Application: SCANIA 114 (340/ 360/ 380)



- 安裝前，請先潤滑工具內部。
- 特殊的錐形設計讓活塞安裝更快速、省力！
- 此工具可將活塞導入汽缸套裡。
- 適用車種：SCANIA 114 (340/ 360/ 380) 卡車

H.C.B-C1353

NEW

KNORR-BREMSE DISC BRAKE SERVICE KIT

卡車碟煞 (KNORR-BREMSE) 維修組

- A complete service kit for Knorr-Bremse disc brake set.
- Series of disc brake: SN6/ SN7/ SK7/ ADB22X
- Application: Most of European trucks.
Such as: SCANIA, VOLVO...etc.
- T26 tool: To replace the cap the press-in tool (T26) is required.
- T27 tool: To replace the cover 68c, 68e and guide sleeve.



- 維修 Knorr-Bremse 碟式煞車的完整工具組。
- 適用煞車系列：SN6/ SN7/ SK7/ ADB22X
- 適用車種：大部份的歐系卡車。
例如：SCANIA · VOLVO... 等。
- T26 工具：用來更換蓋子
- T27 工具：用來更換 68c, 68e 和襯套



Press-in tool for
cover (68c/68e)
T27



H.C.B-A1353

KNORR-BREMSE DISC BRAKE SERVICE KIT

卡車碟煞 (KNORR-BREMSE) 維修組

- A complete service kit for Knorr-Bremse disc brake set.
- Series of disc brake: SN6/ SN7/ SK7/ ADB22X
- Application: Most of European trucks.
Such as: SCANIA, VOLVO...etc.



- 維修 Knorr-Bremse 碟式煞車的完整工具組。
- 適用煞車系列：SN6/ SN7/ SK7/ ADB22X
- 適用車種：大部份的歐系卡車。
例如：SCANIA · VOLVO... 等。

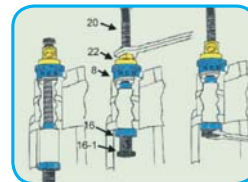
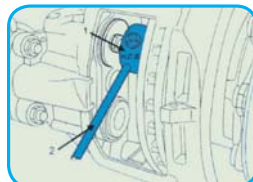

H.C.B-B1353

CALLIPER ADJUSTER SOCKET (H24, 5 TEETH)

卡鉗調整器套筒 (H24, 5 齒)

- To combine with A1353.
- Size: H24, 5 teeth, 46 mm/L
- Material: SCM440
- 搭配 A1353 一起使用。
- 尺寸：H24, 5 齒, 46 mm/L
- 材質：SCM440



H.C.B-A1444

SCANIA TRUCK REAR WHEEL AXLES HUB REMOVER (ALL MODELS)

SCANIA 卡車帶動軸輪殼拆卸工具 (全車系)

VIDEO



- SCANIA axle bearing will be stuck when it's overheated, so use H.C.B-A1444 with wrench to solve this problem.
- Application: SCANIA all models
- 當 SCANIA 卡車輪軸軸承過熱咬死，使用此工具搭配氣動板手拆卸的更輕鬆、容易
- 適用車種：SCANIA 全車系

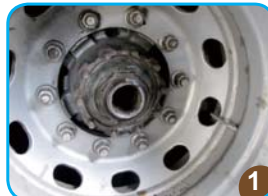

1 Firstly, Scania rear wheel nut (Dr.3/4", 8 POINTS, 100mm) should be extracted.



2 Use H.C.B-B1126 to extract scania rear wheel nut before using A1444



3 Put center fix plate of A1444 on hub



4 Finally, use A1444 with wrench to extract scania (310/320) rear wheel axle hub

H.C.B-A1281

BPW 16 TONS ROLLER AXLE NUT SOCKET (Dr. 3/4", 6 POINTS, 85 mm)

BPW 16 噸輪軸螺母套筒 (Dr. 3/4", 6 角, 85 mm)

- To remove the nut then replace the new bearing with adjustable torque wrench. (Please follow the standard operating manual of origin.)
- 和扭力扳手一起使用，以移除螺母並更換新培林。(請遵照原廠規範操作)



Dr. 3/4"



Dimension: SW 85 mm

H.C.B-A2193

DIESEL INJECTOR PULLER

柴油噴油嘴拆卸器

20 / 24 / 24.5 / 1.38"



- Assist to remove stubborn BOSCH and LUCAS diesel injectors for saving time.
- With M8, M12, M14 adapters M8 x P 0.75 / M12 x P 1.5 / M14 x P 1.5
- Application: VOLVO, SCANIA (ex. 113(320))
- 協助拆卸卡緊的 BOSCH 和 LUCAS 柴油噴油嘴，可節省時間。
- 有 M8, M12, M14 三種接頭 M8 x P0.75 / M12 x P1.5 / M14 x P 1.5
- 適用車種：VOLVO, SCANIA(例如：113(320))



Model : VOLVO, SCANIA(M14xP1.5)

Model : BOSCH (M12xP1.5)

H.C.B-A1490

SCANIA 113 (10 SPEED) TRANSMISSION MAINSHAFT/ COUNTERSHAFT/ INPUT SHAFT BEARING PULLER

SCANIA 113 (10 速) 變速箱主軸 / 副軸 / 輸入軸 培林拆卸器

- Formerly, engineers extract the bearings by damaging the bearing. It might damage the part and the shaft. Use this tool can extract the five bearings easily and won't damage the parts.
- The best tool for removing SCANIA 113 transmission bearings.
- Application: SCANIA 113



This tool can extract the five bearings of the shaft
此工具可拆卸 5 個培林

- 此工具可拆卸變速箱的主軸、副軸與輸入軸的培林
- 以往若無使用工具，會使用破壞性方法來拆卸培林，這樣容易損害到零件，使用此工具可以輕鬆拆卸變速箱的主軸、副軸與輸入軸的 5 個培林，過程中不會損害到相關零件
- 適用車種：SCANIA 113

H.C.B-B1490

SCANIA 113 (10 SPEED) TRANSMISSION MAINSHAFT/ COUNTERSHAFT/ INPUT SHAFT BEARING INSTALLER

SCANIA 113 (10 速)
變速箱主軸 / 副軸 / 輸入軸培林安裝工具

- The best tool for installing SCANIA 113 transmission bearing.
- Won't damage the bearing and related parts.
- Application: SCANIA 113 10 speed transmission
- 不會損壞培林或相關零件
- 方便使用，省時又省錢
- 適用車種：SCANIA 113 10 速變速箱

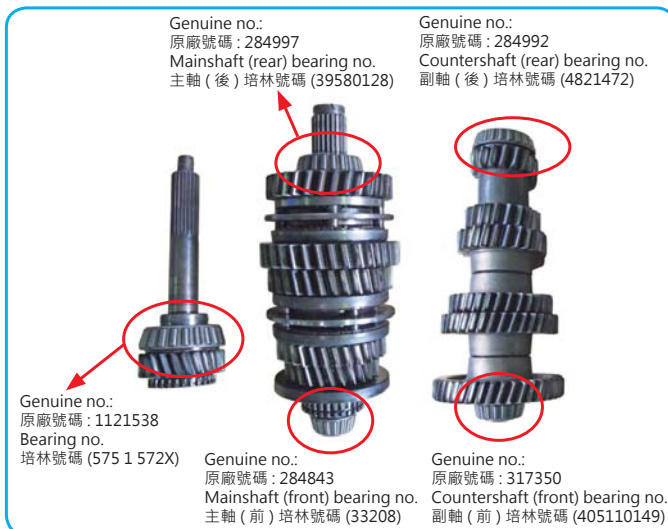

H.C.B-C1490

SCANIA 113 (10 SPEED) TRANSMISSION MAINSHAFT/ COUNTERSHAFT/INPUT SHAFT BEARING REMOVAL/ INSTALLATION TOOL

SCANIA 113 (10 速)
變速箱主軸 / 副軸 / 輸入軸 培林拆裝工具

- Formerly, engineers extract the bearings by damaging the bearing. It might damage the part and the shaft. Use this tool can extract and install the five bearings easily and won't damage the parts.
- Application: SCANIA 113
- 此工具可拆卸、安裝變速箱的主軸、副軸與輸入軸的培林。
- 以往若無使用工具，不易拆裝，過程耗時許多時間與人力，使用此工具可以輕鬆拆卸、安裝變速箱的主軸、副軸與輸入軸的 5 個培林，過程中不會損害到相關零件，可搭配油壓工具來使用。
- 適用車種：SCANIA 113



VIDEO



Removal Installation



H.C.B-A1478

SCANIA 310 (112) & 320 (113) EXTRACTOR

SCANIA 310(112) & 320(113) 傳動軸接座 & 曲軸油封接座拔卸器

- When SCANIA truck front crankshaft oil seal connector base and propeller shaft connector base are overheated, use H.C.B-A1478 with air wrench to replace oil seal.
- Instruction:
Put H.C.B-A1478-1 main plate onto holes of front crankshaft oil seal connector base or propeller shaft connector base, and fix screws, turning the center screw bar to remove oil seal.
- Save time and labor, it is your best choice!
- Application: SCANIA 310 (112), 320 (113) Truck

- 當 SCANIA 卡車前曲軸油封接座或傳動軸接座過熱咬死，使用此工具搭配氣動扳手拆卸，即可拆卸更換油封。
- 將拆卸盤對準前曲軸油封接座或傳動軸接座孔，將螺絲固定鎖緊後，再轉動中心螺桿即可取出。
- 既省力又方便有效率，是您賺錢的最佳利器。



Parts No.	Description	Specification
1	Main Plate	H46 Ø200x L36
2	Center screw bar	H30 TM30W6 L283
3	Center top block	Ø58xL20
4	Fixing screw	H19 M12xP1.75xL55
5	Fixing screw	H19 M12xP1.75xL40

H.C.B-D1391

SCANIA REAR WHEEL HUB INNER BEARING EXTRACTOR

SCANIA 後輪軸內側培林拔卸器

- Feature: This tool is designed to extract SCANIA rear wheel hub inner bearing. With this tool, you can remove the bearing quickly and easily.
- Application: All SCANIA
- 說明：此工具用來拔除 SCANIA 後輪內側培林，讓您在拔除培林的過程更加快速、方便。
- 適用車種：SCANIA 全車系



VIDEO

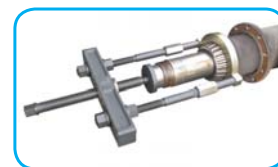

H.C.B-E1391

SCANIA REAR WHEEL HUB INNER BEARING INSTALLER

SCANIA 後輪軸內側培林安裝器

- Feature: This tool is designed to install SCANIA rear wheel hub inner bearing. With this tool, you can install the bearing quickly and easily.
- Application: All SCANIA truck.
- 說明：此工具用來安裝 SCANIA 後輪內側培林，讓您在安裝培林的過程更加快速、方便。
- 適用車種：SCANIA 全車系



VIDEO



拿鐵錘敲打工具的前端直至培林安裝完成
Use hammer hit the front of the tool until bearing install finish.



培林安裝完成！
Finish installing.

H.C.B-A1050-2 BPW TRAILER REAR WHEEL SOCKET (12 TONS) (H41, OVAL, 111 mm)

BPW 板車輪軸蓋拆裝套筒 (12 噸) (H41, 橢圓, 111mm)

10 / 29.5 / 30 / 0.91'

- For extracting the rear axle cover.
- Application: BPW 12 tons
- 可拆裝後輪軸蓋的套筒。
- 適用車種：BPW 12 噸



H.C.B-B1050-2 BPW TRAILER REAR WHEEL SOCKET (6.5~9 TONS) (Dr. 3/4", OVAL, 95 mm)

BPW 板車輪軸蓋拆裝套筒 (6.5~9 噸) (Dr. 3/4", 橢圓, 95mm) Dr. 3/4"

10 / 20.5 / 21.5 / 0.56'

- For extracting the rear axle cover.
- Application: BPW 6.5~9 tons
- 可拆裝後輪軸蓋的套筒。
- 適用車種：BPW 6.5~9 噸



H.C.B-A1050-3 BPW TRAILER REAR WHEEL SOCKET (FORMER 16 TONS) (H41, 8 POINTS, 120 mm)

BPW 板車輪軸蓋拆裝套筒 (舊型 16 噸) (H41, 8 角, 120mm) H41

8 / 23.2 / 25.2 / 0.92'



H.C.B-B1050-3 BPW TRAILER REAR WHEEL SOCKET (NEW 16 TONS) (Dr. 3/4", 8 POINTS, 110 mm)

BPW 板車輪軸蓋拆裝套筒 (新型 16 噸) (Dr. 3/4", 8 角, 110mm)

8 / 25.5 / 26.5 / 1.27'

- Socket for the rear axle cover.
- 可拆裝後輪軸蓋的套筒。

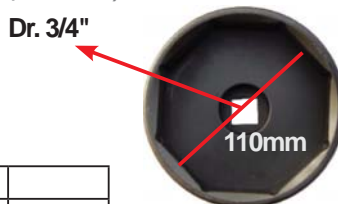

Item No.	Size	Model	
H.C.B-A1050-3	120mm	Former BPW 16T	H41
H.C.B-B1050-3	110mm	New BPW 16T	Dr. 3/4"

H.C.B-A1050-4

BPW TRAILER REAR WHEEL SOCKET (12 TONS) (H41, 8 POINTS, 109 mm)

BPW 板車輪軸蓋拆裝套筒 (12 噸) (H41, 8 角, 109mm)

8 / 18.4 / 20.2 / 0.75'

- Socket for the rear axle cover.
- Application: BPW 12 tons
- N.W.: 2.9 KGS

- 可拆裝後輪軸蓋的套筒。
- 適用車種：BPW 12 噸
- 淨重：2.9 公斤



H41



H.C.B-A1050-6

BPW TRAILER REAR WHEEL SOCKET (12 TONS) (Dr. 1", OVAL, 111 mm)

BPW 板車輪軸蓋拆裝套筒 (12 噸)
(Dr. 1", 橢圓, 111mm)

8 / 21.5 / 23 / 0.88'

- Socket for the rear axle cover.
- 可拆裝後輪軸蓋的套筒。



Dr. 1"



VIDEO



H.C.B-B1050-6

BPW TRAILER REAR WHEEL SOCKET (12 TONS) (Dr. 1", OVAL, 108 mm)

BPW 板車輪軸蓋拆裝套筒 (12 噸) (Dr. 1", 橢圓, 108mm)

- Size: Dr. 1", OVAL, 108mm
- Application: BPW 12 Tons trailer
- 尺寸：Dr. 1", 橢圓, 108mm
- 適用車種：BPW 12 噸板車



Dr. 1"



- Aftermarket wheel shaft cover from china
- 大陸製輪軸蓋

H.C.B-C1050-6

BPW TRAILER REAR WHEEL SOCKET (13~14 TONS) (Dr. 1", OVAL, 120 mm)

BPW 板車輪軸蓋拆裝套筒 (13~14 噸) (Dr. 1", 橢圓, 120 mm)

- Size: Dr. 1", OVAL, 120 mm
- Application: BPW13~14 Tons trailer
(from 11/2004)

- 尺寸：Dr. 1", 橢圓, 120mm
- 適用車種：BPW13~14 噸板車
(從 11/2004)

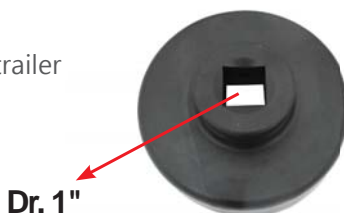

Dr. 1"



H.C.B-D1050-6

BPW TRAILER REAR WHEEL SOCKET (Dr. 1", 109 mm)

BPW 板車輪軸蓋拆裝套筒 (Dr. 1" , 109 mm)

- Size: Dr. 1", 109 mm
- Application: BPW 12 Tons trailer
- 尺寸 : Dr. 1", 109 mm
- 適用車種 : BPW 12 噸板車



H.C.B-A1066-3-1

BPW 12 TONS AXLE EXTRACTOR (M135 x P2.0)

BPW 12 噸輪軸拔取器 (M135 x P2.0, 內牙)

4 / 30 / 31 / 1.65'

- Specification: M135 x P2.0
- Screw specification: TM30 x W6
- Application: BPW ECO 10~12 tons old model
- 規格 : M135 x P2.0
- 螺絲規格 : TM30 x W6
- 適用車種 : BPW ECO 10~12 舊型拖車



H.C.B-A1066-3-2

BPW 12 TONS AXLE EXTRACTOR (M136 x P2.5)

BPW 12 噸輪軸拔取器 (M136 x P2.5, 內牙)

- Specification: M136 x P2.5
- Screw specification: TM30 x W6
- Application: BPW ECO Plus 8~12 tons, BPW EXO 10 tons new model.
- 規格 : M136 x P2.5
- 螺絲規格 : TM30 x W6
- 適用車種 : BPW ECO Plus 8~12 噸、BPW 10 噸新型拖車



H.C.B-A1066-2

BPW 16 TONS AXLE EXTRACTOR (M155 x P3.0)

BPW 16 噸輪軸拔取器 (M155 x P3.0, 外牙)

4 / 23 / 24 / 1.65'

- Specification: M155 x P3.0
- Screw specification: TM30 x W6
- 規格 : M155 x P3.0
- 螺絲規格 : TM30 x W6



H.C.B-A1066-1

BPW 12 TONS AXLE EXTRACTOR (M125 x P2.0)

BPW 12 噸輪軸拔取器 (M125 x P2.0 · 外牙)

6 / 29 / 30 / 2.2'

- Specificatin: M125 x P2.0
- Screw specification: TM30 x W6
- For former 12 tons trailer

- 規格 : M125 x P2.0
- 螺絲規格 : TM30 x W6
- 適用於舊型 12 噸拖車



H.C.B-A1171

BPW 12 TONS ROLLER AXLE NUT SOCKET (Dr. 3/4")

BPW 12 噸板車輪軸螺母套筒 (Dr. 3/4")

- H.C.B-A1171 / H.C.B-B1171 is to remove the fix nut then replace the new bearing with adjustable torque wrench. Plese follow the standard operation manual of origin.

- 更換 BPW 12TON 卡車後輪軸承必須先使用 H.C.B-A1050-2 拆下輪軸蓋。
- 使用 H.C.B-A1171 拆下固定螺帽，更換新軸承並配合扭力

Dr. 3/4"



BPW Code No.:
03.266.47.03.0
Dimension:
M 52 x 2 / SW 80

H.C.B-B1171

BPW 6.5 ~ 9 TONS ROLLER AXLE NUT SOCKET (Dr. 3/4")

BPW 6.5~9 噸板車輪軸螺母套筒 (Dr. 3/4")

12 / 9.96 / 11 / 0.78'

Material(材質): SCM 440
Hardness(硬度): 45° -50°

Dr. 3/4"

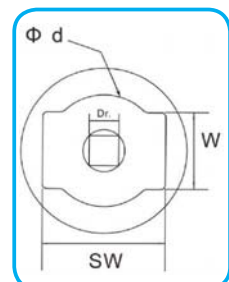

- Remove the lid of axle on BPW 12 tons / 6.5~9 tons with H.C.B-A1050-2 / H.C.B-B1050-2 before using this tool.
- H.C.B-A1171 / H.C.B-B1171 is for removing the fixed nut then replace the new bearing with adjustable torque wrench. Please follow the standard operation manual of origin.
- 更換 BPW 12 噸 / BPW 6.5-9 噸拖車後輪培林前，必須先用 H.C.B-A1050-2 / H.C.B-B1050-2 拆下輪軸蓋。
- 使用 H.C.B-A1171 / H.C.B-B1171 拆下固定螺帽，更換新培林，並配合扭力扳手一起使用。(請遵照原廠規範操作)

Item No.	SW	W	Ød	Dr.
H.C.B-A1171	80mm	50mm	73mm	3/4"
H.C.B-B1171	64.5mm	40mm	61mm	3/4"
H.C.B-C1171	85mm	52.5mm	82mm	3/4"

H.C.B-C1171

BPW 13~14 TONS ROLLER AXLE NUT SOCKET (Dr. 3/4")

BPW 13~14 噸板車輪軸螺母套筒 (Dr. 3/4")

- Remove the lid of axle on BPW 12 tons trailer with H.C.B-A1050-2 before use this tool.
- Material : SCM440
- HRC : 45°-50°
- To remove the fix nut then replace the new bearing with adjustable torque wrench. Please follow the standard operation manual of origin.

- 更換 BPW 12 噸卡車後輪軸承必須先使用 H.C.B-A1050-2 拆下輪軸蓋。
- 拆下固定螺帽，更換新軸承並配合扭力扳手，按照原廠規範操作。
- 材質：SCM440
- 硬度：45°-50°



BPW CODE NO.: D-03.262.17.19.0



H.C.B-A1071

MAN(422/403), BENZ TRUCK DIESEL INJECTION VALVE SOCKET

MAN (422/403), BENZ 卡車柴油噴油嘴專用套筒

48 / 8.16 / 10 / 0.67'

- To remove and install diesel injection valve.
- Application: MAN 422/403, BENZ truck, SCANIA
- 移除和安裝柴油噴油嘴。
- 適用車種：MAN 422/403, BENZ 卡車, SCANIA



H.C.B-A1075

MAN FRONT WHEEL HUB EXTRACTOR

MAN 卡車前輪 HUB 拔卸器

4 / 17 / 17.5 / 1.38'

- For removing the front wheel hub.
- Application: MAN truck
- Specification: M115 x P1.5
- 用來拔卸前輪 HUB。
- 適用車種：MAN 卡車
- 規格：M115 x P1.5



H.C.B-A1228

MAN TRUCK TRANSMISSION SOCKET (Dr. 3/4")

MAN 卡車變速箱專用套筒 (Dr. 3/4")

- Application: MAN 410/414
- 適用車種：MAN 410/414

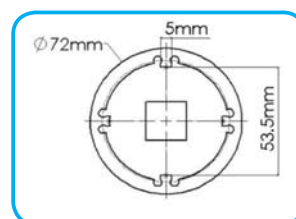

H.C.B-B1075

MAN FRONT WHEEL HUB INSTALLER

MAN 卡車前輪 HUB 安裝器

- For installing front wheel hub of MAN.
- There is a bearing inside the tool, to save effort.
- Specification: M40 x P1.5
- 安裝 MAN 卡車前輪 HUB。
- 工具內附加培林更省力、安全便利。
- 內牙尺寸：M40xP1.5



H.C.B-A1172

MAN AXLE BEARING EXTRACTOR

MAN 卡車輪軸培林拆卸器

2 / 17.7 / 19 / 1.47"

- For replacing MAN truck hub bearings and removing the old bearings.
- Turn the screw to remove the bearing.
- 更換 MAN 卡車 Hub 培林及拆卸舊培林的必備工具
- 只需轉動螺絲便可拆卸培林

TM30 x W6

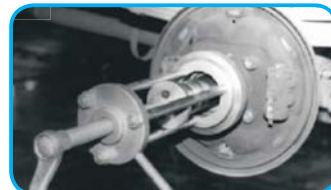

H.C.B-B1172

MAN TRACTOR (33460/410/414) AXLE BEARING EXTRACTOR

MAN 卡車前輪 (33460/410/414) 輪軸培林拆卸器

- Best tool for replacing MAN tractor hub bearings and removing the old bearings.
- Turn the screw and remove the bearing.
- Application: MAN truck tractor 33460/410/414 with front disc brake bearing.
- 更換 MAN 拖車頭 HUB 培林及拆卸培林的必備工具
- 只需轉動螺絲便可拆卸培林
- 適用車種：MAN 拖車頭 33460/410/414 前碟剎輪軸培林



No. 331933 / Q
No. FGA 575194
AUSTRALIA 149A A



H.C.B-A1203

MAN TRUCK DIFFERENTIAL BEARING EXTRACTOR

MAN 卡車差速器培林拆卸器

- For replacing MAN differential bearing and removing the old bearings.
- Turn the screw to remove the bearing
- 用來移除舊 MAN 差速器培林，並更換新培林。
- 轉動螺桿來移除培林。



H.C.B-A1273

MAN (FE410A/FE414) PITMAN ARM PULLER (Dr. 3/4", 67 mm)

MAN (FE410A/FE414) 卡車方向機搖臂拆卸器 (Dr. 3/4", 67 mm)

5 / 23 / 23.5 / 0.74'

- The tool is designed for extracting pitman arm of MAN. It's different from traditional. This one can prevent pitman arm from damage.
- Use H6, 70 mm socket to remove the fixed nut on the pitman arm before using this tool.
- Application: MAN tractor trailer FE410A, FE 414.
- 本工具設計用來拆卸 MAN 的搖臂。和傳統的工具不同，本工具可以避免損害搖臂。
- 使用本工具之前，請用 H6, 70mm 的套筒移除搖臂上的固定螺帽。
- 適用車種：MAN 拖車 FE410A · FE 414

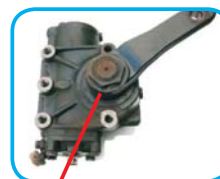

To loosen the fixed nut on the arm before using A1273



H.C.B-A1274

MAN (FE410A) STEERING MECHANISM OIL SEAL SOCKET (Dr. 1/2", 4 POINTS)

MAN (FE410A) 卡車方向機油封套筒 (Dr. 1/2", 4 點)

- To replace steering mechanism oil seal by loosening tightening the nut.
- It might damage the related parts while replacing the oil seal without this tool.
- Application: MAN tractor FE410A
- 藉由鬆開 / 鎖緊螺帽，來更換油封。
- 更換油封時，若不使用本工具，有可能會損害相關零配件。
- 適用車種：MAN 拖車 FE410A

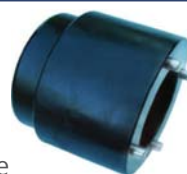

PCD 58 mm x 7/32" x 4 POINTS

H.C.B-B1239

MAN FRONT WHEEL HUB REMOVER (20 TONS HYDRAULIC)

MAN 前輪輪殼拔卸器 (20 噸油壓缸)

- If axle bearing of MAN is stuck due to overheating, use this tool with air wrench for labor saving and easier removal.
- With the 20 tons hydraulic, let maintenance work faster and easier.
- P.C.D.: Ø166 mm
- Application: MAN truck
- 當 MAN 輪軸因為過熱而卡死，可用此工具來拔卸前輪輪殼。
- 搭配 20 噸油壓缸，讓維修工作變得更快與方便。
- P.C.D.: Ø166 mm
- 適用車種：MAN 卡車



H.C.B-A1239

MAN TRUCK FRONT WHEEL HUB REMOVER

MAN 卡車前輪 HUB 拔卸器

- When MAN'S axle bearing is stuck due to overheating, use this tool with air wrench for labor saver and easier removal.
- P.C.D.: Ø166 mm
- Application: MAN new type truck
- 當 MAN 輪軸因為過熱而卡死，可用本工具配合氣動扳手來拔卸前輪 HUB。省時又省力。
- P.C.D.: Ø166mm
- 適用車種：MAN(新型) 卡車

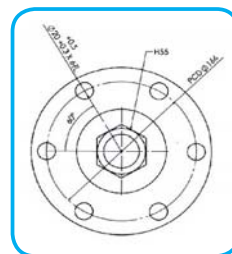

H.C.B-A1328

MAN TGA FRONT WHEEL AXLE NUT SOCKET (Dr. 3/4", H60, 93 mm)

MAN TGA 卡車前輪軸 & 後輪舉升軸螺帽套筒
(Dr. 3/4", H60, 93 mm)

10 / 27.5 / 28.5 / 0.74"

- Fix bearing while removing or installing the truck nut.
- Use the air wrench or rod to control the nut to tighten or loosen bearing.
- Application: MAN-TGA front wheel
- 移除或安裝卡車前輪螺帽時，需使用本工具固定來培林。
- 使用氣動扳手或扳桿來控制螺帽，以鎖緊或鬆開培林。
- 適用範圍：MAN-TGA 前輪軸 & 後輪舉升軸 (410/414/640)

Dr. 3/4"



H.C.B-A1329

MAN TGA DRIVE AXLE NUT SOCKET (Dr. 3/4", H60, 158 mm)

MAN TGA 卡車帶動軸螺帽套筒 (Dr. 3/4", H60, 158 mm)

4 / 18.5 / 19.5 / 1.64"

- Fix bearing while removing or installing the truck nut.
- Use the air wrench or rod to control the nut to tighten or loosen bearing.
- Application: MAN-TGA (410/414/460) drive axle
- 移除或安裝卡車帶動軸螺帽時，需使用本工具來固定培林。
- 使用氣動扳手或扳桿來控制螺帽，以鎖緊或鬆開培林。
- 適用範圍：MAN-TGA(410/414/460) 帶動軸

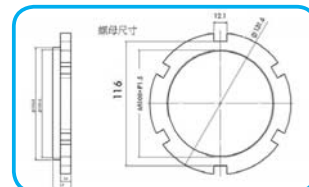
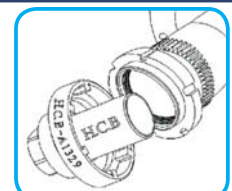

H.C.B-B1329

NEW

MAN TGA DRIVE AXLE NUT SOCKET (Dr. 3/4")

MAN TGA 卡車帶動軸螺帽套筒 (Dr. 3/4")

- Fix bearing while removing or installing the truck nut.
- Use the air wrench or rod to control the nut to tighten or loosen bearing.
- Application : MAN-TGA rear wheel
- 移除或安裝卡車後輪螺帽時，需使用此工具來固定培林。
- 使用氣動扳手或扳桿來控制螺帽，以鎖緊或鬆開培林。
- 適用範圍：MAN-TGA 後輪



H.C.B-A1344

MAN, BENZ DIFFERENTIAL REAR NUT SOCKET (Dr. 3/4", 6 TEETH)

MAN, BENZ 卡車差速器後螺母套筒 (Dr. 3/4", 6 齒)

6 / 25 / 26 / 0.74'

- For removing the differential rear nut.
- Application: MAN, Benz truck
- 用來移除差速器後螺母。
- 適用車種：MAN, Benz 卡車

Specification / 規格：

Teeth / 齒數	6	
Size of tooth / 尺寸	8.7 mm	
Inner Diameter / 內徑	Tooth to tooth / 齒對齒	113 mm
	Side to side / 邊到邊	126 mm

Dr. 3/4"



Nut Size

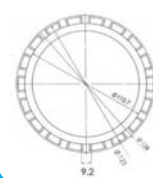

H.C.B-A1345

MAN, BENZ DRIVE AXLE NUT SOCKET(Dr. 3/4", H60, 6 TEETH)

MAN, BENZ 卡車帶動軸螺帽套筒 (Dr. 3/4", H60, 6 齒)

6 / 18 / 19 / 0.74'

- For removing the drive axle nut.
- Application: MAN, Benz truck
- 用來移除帶動軸螺帽。
- 適用車種：MAN · Benz 卡車

Specification / 規格：

Teeth / 齒數	6	
Size of tooth / 尺寸	11.5 mm	
Inner Diameter / 內徑	Tooth to tooth / 齒對齒	102 mm
	Side to side / 邊到邊	111 mm

Dr. 3/4"



H.C.B-A2132

MAN STAR-E IMPACT SOCKET (Dr. 3/4", E18/E20) (FOR HGV CYLINDER-HEAD BOLT)

MAN 卡車星型衝擊式套筒 (Dr. 3/4", E18/E20)(汽缸床用)

- Suitable for torque wrenches.
- Reinforced design.
- Chrome-Vanadium special steel / surface burnished.
- Dr. 3/4", 90 mm



- 可和扭力扳手一起使用。
- 強化型的設計。
- 材質：鉻釩鋼，表面拋光
- 規格：Dr. 3/4", 90 mm

H.C.B-A2132 **E18**
On MAN commercial vehicles M2000 and MAN buses with D08 engines
適用車種：MAN 商務車 M2000 和 搭載 D08 引擎的 MAN 遊覽車

H.C.B-A2132 **E20**
On MAN commercial vehicles F2000, F90, F8 and MAN buses with D25 and D28 engines
適用車種：MAN 商務車 F2000 · F90 · F8 和 搭載 D25 · D28 引擎的 MAN 遊覽車

H.C.B-B2132

MAN STAR-E IMPACT SOCKET KIT(FOR HGV CYLINDER-HEAD BOLT)

MAN 卡車星型衝擊式套筒 (汽缸床用)

- Suitable for impact wrenches.
- Reinforced design.
- Chrome-Vanadium special steel / surface burnished.
- Dr. 3/4", 90 mm
- 可和扭力扳手一起使用。
- 強化型的設計。
- 材質：鉻釩鋼，表面拋光
- 規格：Dr. 3/4" · 90 mm



Item No. 編號	Applicable 適用車種	Specification 規格
H.C.B-B2132-17	For Benz engines 400, 420 Benz 引擎 400 · 420	Dr. 3/4", 12 points, 17 mm Dr. 3/4", 12 角, 17 mm
H.C.B-B2132-19	For Benz engine 300, 400, Ex. ACTORS Benz 引擎 300 · 400 · 例如：ACTORS	Dr. 3/4", 12 points, 19 mm Dr. 3/4", 12 角, 19 mm
H.C.B-B2132-E18	For MAN commercial vehicles M2000 and MAN buses with D08 engine. MAN 商務車 M2000 和 搭載 D08 引擎的 MAN 遊覽車	Dr. 3/4", E18
H.C.B-B2132-E20	For MAN commercial vehicles F2000, F90, F8 and MAN buses with D25 and D28 engine. MAN 商務車 F2000, F90, F8 和 搭載 D25, D28 引擎的 MAN 遊覽車	Dr. 3/4", E20
H.C.B-B2132-E24	For MAN commercial vehicles with D20 engine. MAN 搭載 D20 引擎的 MAN 商務車	Dr. 3/4", E24



H.C.B-C2132

MAN STAR-E IMPACT SOCKET KIT (FOR HGV CYLINDER-HEAD BOLT) (6 PCS) (E18/E20/E22/E24/17 mm/19 mm) (6 POINT)

MAN 卡車星型衝擊式套筒組 (汽缸床用)
(6 PCS) (E18/E20/E22/E24/17 mm/19 mm) (6 角)

- For removing the cylinder head bolts from engines.
- Size: E18, E20, E22, E24, 17 mm, 19 mm .(12Points)
- Application: MB 300-400-420-500-900
MAN M2000, F90, F8, D20, D25, D28
- E24 can use on MAN front/rear wheel cover
- 拆除汽缸頭螺絲
- 尺寸：E18.E20.E22.E24.17 mm.19 mm(12 角)
- 適用車種：MB 300-400-420-500-900MAN M2000,F90,F8,D20,D25,D28
- E24 可以用於 MAN 前後輪軸蓋



H.C.B-A1169

VOLVO TRUCK FRONT / REAR BRAKE SHOE LINING INSIDE CALIPER

VOLVO 卡車前後輪煞車來令片更換卡鉗夾

10 / 18.7 / 20 / 1.69'

- Extend wider and hold open brake shoe steel by locking A 1169 inside caliper closer. Take out the bolts and change new brake shoe lining.
- Application: VOLVO trucks. VOLVO N7, N10, N12, F7, F12, F16, FH12, FH16, FL7, FL10 ERF E Series and EC Series
- OEM no.: 9998550

- 更換 VOLVO 前、後輪煞車來令片前，必須先用此工具拆下固定銷。
- 適用車種：VOLVO N7, N10, N12, F7, F12, F16, FH12, FH16, FL7, FL10 ERF E 系列與 EC 系列



VIDEO



H.C.B-B1102

EUROPEAN TRUCK BALL JOINT REMOVER (39 MM) PAT.M362085

歐系卡車球接頭拔卸器 (39 mm)

10 / 21.5 / 22.5 / 1'

- On car maintenance.
- The best tool for removing truck ball joint.
- No damage to ball joint and related parts.
- Easy to use. Save time and money.
- Specification: Nut width 26 mm, bolt length 128 mm
- Application: Over 4 tons and most of European trucks. For example SCANIA, BENZ, MAN, HINO, also can use for DAF PITMAN ARM DAF...etc.
- Special for MAN 414 drag link.

- 免拆零件、車上維修。
- 拆卸球接頭的利器。
- 不會損壞球接頭及相關零件。
- 操作簡便。省時又省錢。
- 規格：螺帽寬 -26 mm · 螺桿長 -128 mm ·
- 適用車種：4 噸以上及大部份的歐系卡車。例如：SCANIA, BENZ, MAN, HINO, 也可用在 DAF 方向機搖臂 ... 等。
- 特別適用於 MAN 414 方向機直拉桿。



Window



Central ball of Bolt
■ 鋼珠設計更堅固耐用

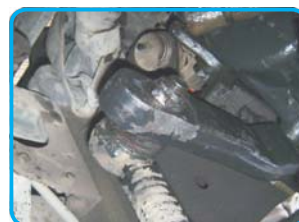

H.C.B-A2018-19

MAN TRUCK OIL FILTER WRENCH (Dr. 1/2", 18 POINTS, 135 mm)

MAN 卡車機油芯扳手 (Dr. 1/2", 18 角, 135 mm)

- Application: MAN truck. Series F2000, FE and TGA engine. (460, 410, 414, 440, 460)
- 適用車種：MAN 卡車。F2000, FE 和 TGA 引擎的車系。(406, 410, 414, 440, 460)



H.C.B-A1176

VOLVO WHEEL SHAFT COVER SOCKET (Dr. 3/4", 8 POINTS, 115 mm)

VOLVO 卡車輪軸蓋套筒 (Dr. 3/4", 8 角, 115 mm)

8 / 21.5 / 22.5 / 0.85"

- Application: VOLVO front/ rear shaft cover, Renault(After 2007), FH 12/16 (After 1993)
- Size: 115 mm, 8 points
- 適用 VOLVO 前後輪軸拆卸, 雷諾 (2007 以後), FH 12/16(1993 以後)

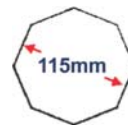

H.C.B-B1175

VOLVO (MP8/MP10) & RENAULT (370) FLYWHEEL TURNING TOOL

VOLVO (MP8/MP10) & RENAULT (370) 曲軸飛輪轉動工具

- Remove plugs of flywheel cover and place the rotation tool H.C.B-B1175 to rotate the flywheel.
- Application: Volvo truck (MP8 / MP10), (FH, D13A520), Renault (370)
- OEM no. ref.: 88800014
- 藉由此工具轉動曲軸飛輪來校正正時。
- 適用車種：VOLVO 卡車 (MP8 / MP10) · (FH, D13A520), Renault (370)
- 原廠號碼：88800014

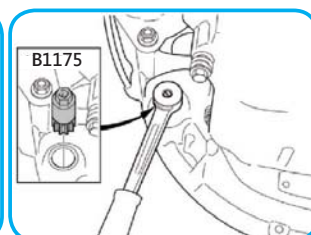
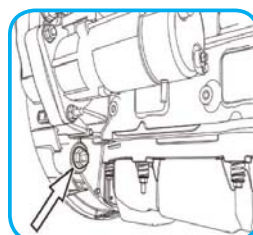

H.C.B-C1175

VOLVO TRUCK FLYWHEEL ROTATING TOOL

VOLVO 卡車飛輪轉動工具

- Gear for rotating engine flywheel during the timing search.
- Application: VOLVO
- OEM no. ref.: 9998068
- 適用車種 : VOLVO
- 此工具用於旋轉引擎飛輪以尋找正時位置。
- 原廠料號 : 9998068

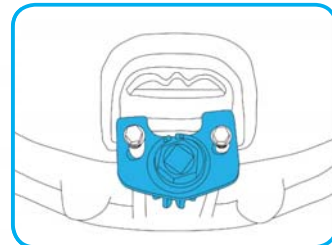

H.C.B-A1910

NEW

VOLVO/ MACK LEAF SPRING PIN SOCKET

VOLVO/ MACK 彈簧插銷套筒

- Remove and install even the most stubborn threaded leaf spring and shackle pins on Volvo and Mack suspensions. Refer to dimensions to ensure compatibility.
- Applications : Volvo and Mack.
- VOLVO OEM no.ref.: 9996791
- 拆卸及安裝 Volvo 和 Mack 的鋼板插銷
- 適用車種 : Volvo 和 Mack.
- VOLVO OEM 原廠號碼 : 9996791



H.C.B-A1175

VOLVO (MP7) FLYWHEEL TURNING TOOL

VOLVO (MP7) 卡車曲軸飛輪轉動器

10 / 8 / 9 / 0.71'

- This tool is designed for rotating crankshaft for timing
- Genuine seock: VOLVO 9996596
- 此工具藉由轉動曲軸飛輪來校正正時
- 原廠料號 : VOLVO 9996596



H.C.B-A1186

VOLVO SHOCK ABSORBER SPRING WASHER REMOVAL SOCKET (H27) (FRONT)

VOLVO 避震器彈簧墊片拆卸套筒 (H27) (前)

- Application: VOLVO e.g. FL6/ F10/ F12
- 適用車種 : VOLVO 例如 : FL6/ F10/ F12



H27

H.C.B-B1186

VOLVO SHOCK ABSORBER SPRING WASHER REMOVAL SOCKET (Dr. 3/4") (REAR)

VOLVO 避震器彈簧墊片拆卸套筒 (Dr. 3/4") (後)

- Application: VOLVO rear axle e.g. FH
- 適用車種：VOLVO 例如：FH

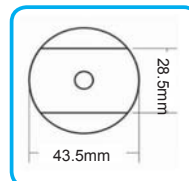

H.C.B-A1229

VOLVO (FM12) TRANSMISSION CLUTCH CALIPER PISTONS DEPTH LEVEL GAUGE

VOLVO (FM12) 卡車變速箱離合器分泵深度量規

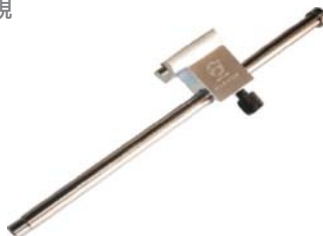

H.C.B-A1238

VOLVO TRUCK AXLE NUT SOCKET (Dr. 3/4", 6 POINTS, 105 mm)

VOLVO 卡車輪軸螺帽套筒 (Dr. 3/4", 6 角, 105 mm)

- Fix bearing while removing or installing the truck nut.
- Use the air wrench or rod to control the nut to tighten or loosen bearing
- 拆卸, 安裝卡車輪軸螺帽時, 用來固定培林
- 以氣動扳手或扳桿控制螺帽, 控制培林的鬆緊度



H.C.B-B1238

VOLVO TRUCK AXLE NUT SOCKET (Dr. 3/4", 6 POINTS, 95 mm)

VOLVO 卡車輪軸螺帽套筒 (Dr. 3/4", 6 角, 95 mm)

- Fix bearing while removing or installing the truck nut.
- Control the nut with air wrench or rod to tighten or loose bearing.
- Application: VOLVO FH rear axle.
- 移除或安裝卡車輪軸螺帽時, 需使用本工具固定來培林。
- 使用氣動扳手或扳桿來控制螺帽, 以鎖緊或鬆開培林。
- 適用範圍：VOLVO 卡車 FH 後輪軸



H.C.B-A1246

VOLVO TRUCK CAB SHOCK ABSORBER UPPER BASE NUT EXTRACTOR / INSTALLER

VOLVO 卡車車頭避震器上座螺帽拆裝器

- For extracting and installing the shock absorber upper base nut of VOLVO truck
- Application: VOLVO truck FL10/ FM12
- 用來拆裝避震器上座螺帽
- 適用車種：VOLVO 卡車 FL10/ FM12



H.C.B-A1247

VOLVO TRUCK OIL FILTER WRENCH (Dr. 1/2", 15 POINTS, 107 mm)

VOLVO 卡車機油芯扳手 (Dr. 1/2", 15 角, 107 mm)

- Genuine stock no.:466634
- Application: VOLVO truck
- 原廠料號：466634
- 適用車種：VOLVO 卡車



H.C.B-A1269

SCANIA/ VOLVO (FM12/ FL10)TRUCK CAB REMOVAL WRENCH (12 POINTS, 22 mm)

SCANIA / VOLVO (FM12/ FL10) 拖車頭拆卸扳手 (12 角, 22 mm)



Hydraulic Valve Switch



Turning on / off Hydraulic Valve Switch



Cab-Lift Hydraulic Valve Adjust Screw



Rotating Cab-Lift Hydraulic Valve Adjust Screw

- Apply park brake. Gear in neutral. Close the doors.
- Before lifting up the cab, turn on hydraulic valve switch with anti-clockwise. Rotating cab-lift hydraulic valve adjust screw with socket, and then lifting the cab gradually.
- When restoring the cab, turn off hydraulic valve switch with clockwise to position. Rotating cab-lift hydraulic valve adjust screw with socket, and then reinstate the cab gradually.
- Application: VOLVO FM12/ FL10/ FH500/ FM 440, SCANIA 340 (114)
- 拉起煞車、放空檔、關好車門。
- 要舉起車頭之前，先逆時針轉動油壓閥開關，再用本工具旋轉油壓閥調整螺絲，慢慢抬起車頭。
- 完成維修後，順時針旋轉油壓閥調整螺絲，慢慢放下車頭。
- 適用車種：VOLVO FM12 / FL10 / FH500 / FM440, SCANIA 340 (114)

H.C.B-A1335

VOLVO (FM12) KING PIN UPPER COVER SOCKET (Dr. 3/4", 6 POINTS, 80mm)

VOLVO (FM12) 卡車大王銷上蓋套筒 (Dr. 3/4", 6 角, 80 mm)

- For removing king pin upper cover.
- Specifications: Dr. 3/4", 6 points, 80 mm
- Application: VOLVO FM12
- 用來拆卸大王銷上蓋。
- 規格：Dr. 3/4" · 6 角, 80 mm
- 適用車種：VOLVO 卡車 FM12



H.C.B-B1350

VOLVO RADIATOR ADAPTOR

VOLVO 卡車水箱快速接頭

- Female adaptor for radiator when purge or refill radiator liquid.
- Application: VOLVO trucks.
- Genuine no.: 9996049
- 可用於排空和灌注水箱水的快速接頭。
- 適用車種：VOLVO 卡車
- 原廠料號：9996049



H.C.B-B1350-H

NEW

COOLANT DRAIN HOSE

VOLVO 卡車水箱快速接頭與管

- Easy to install
- Quality made product
- VOLVO OEM no. ref: 9996049
- 安裝方式非常簡單、快速
- 高品質工具
- VOLVO OEM no. ref: 9996049

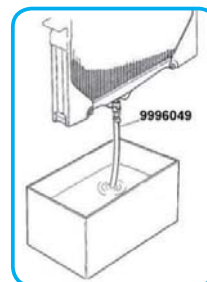

H.C.B-A1363

VOLVO TRUCK KING PIN BEARING PULLER

VOLVO 卡車大王銷培林拔卸器

- For removing king pin bearing.
- Application for VOLVO truck new series after FM12.
- Genuine no.: 9998621
- Stock no. of bearing: SKF 2619334W
- 用來拆除大王銷培林
- 適用車種：VOLVO 卡車 FM12 之後的新車種。
- 原廠編號：9998621
- 培林編號：SKF 2619334W



H.C.B-A1380

VOLVO TRUCK FAN BEARING BASE SOCKET (Dr. 1/2")

VOLVO 卡車風扇軸承底座套筒 (Dr. 1/2")

- This tool is designed for removing nut to replace bearing.
- Application: VOLVO truck, specifically for FM 12
- 此工具是設計用來拆卸螺母更換培林
- 適用車種：VOLVO 卡車 · 特別是 FM12

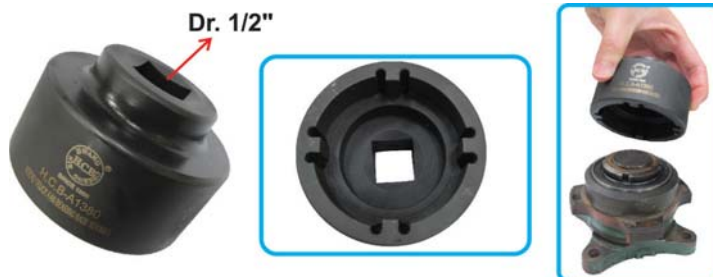

H.C.B-A1402

VOLVO (FM) VALVE SPRING COMPRESSOR TOOL KIT

VOLVO (FM) 汽門彈簧壓縮工具組

10 / 22 / 23 / 2.57'

- The size for the screw: M10 x P1.5, L: 25 mm
- To remove and install the valves of VOLVO trucks
- Application: VOLVO FM TRUCK
- Genuine no.: 9990210
- 螺絲尺寸：M10 x P1.5, L: 25 mm
- 可移除和安裝卡車氣門彈簧來更換油封
- 適用車種：VOLVO FM 卡車
- 原廠料號：9990210

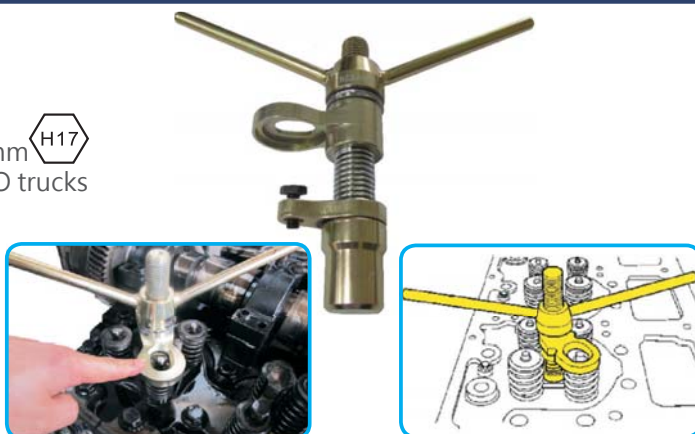

H.C.B-A2018-3

VOLVO, SCANIA TRUCK OIL FILTER WRENCH (Dr. 1/2", 15 POINTS, 107mm)

VOLVO, SCANIA 卡車機油芯扳手 (Dr. 1/2", 15 角, 107mm)

30 / 16.8 / 18 / 1.49'

- For removing oil filter.
- 用來拆除機油芯

Dr. 1/2"



H.C.B-A1695

VOLVO DIFFERENTIAL FLANGE NUT SOCKETS (Dr. 1/2")

VOLVO 傳動軸凸緣盤螺帽套筒 (Dr. 1/2")

- If the disassembly of drive shaft is required, these sockets can remove the differential flange nuts to detach the drive shaft.
- Dimensions: H15 x 150 mmL, H18 x 150 mmL
- VOLVO OEM no. ref.: 9996369, 9996785
- Application: VOLVO truck
- 如欲拆除傳動軸 · 此套筒組可以拆卸差速器凸緣盤螺帽 · 以便卸下傳動軸。
- 尺寸：H15 x 150 mmL, H18 x 150 mmL
- VOLVO 原廠料號：9996369、9996785 ■ 適用車種：VOLVO 卡車

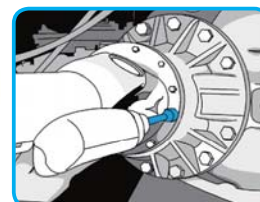

H.C.B-B1393

VOLVO (FM) TRUCK INJECTOR SLEEVE REMOVER/INSTALLER KIT

VOLVO (FM) 噴油嘴銅套拆裝工具組



- Application: VOLVO (FM)
- Operation:
 - Removal: Put the 2-1 puller into cylinder to reach sleeve. Screw top nut to make puller retain sleeve, then install 2-2 puller ring, and assemble No.1 puller, screw top nut and take out the old sleeve.
 - Installation: Put new sleeve into 3-1 expander, then install 3-2 thread tap, finally put the whole tool into cylinder, screw the top nut, then the new sleeve will be installed perfectly.

- 適用車種：VOLVO (FM)
- 操作說明：
 - 拆卸：先將 2-1 號噴油嘴套筒擴張器，插入汽缸內至銅套，轉動上端螺母，使下方擴張器撐住銅套，再放入 2-2 拆卸器墊塊，在接上 1 號拉拔器，轉動拉拔器上端螺母，即可將銅套取出。

安裝：將 3-1 噴油嘴套筒安裝工具本體前端放入銅套，再轉入 3-2 銅套固定桿，放入汽缸內到定位，再轉動上方螺母，即可固定銅套，安裝完成。



PART NO.:85104134
零件型號 :85104134



PART NO.:85124276
零件型號 :85124276



Sleeve no: 21515329

VIDEO



Removal:



Install:



編號 NO.	品名 Description	原廠號碼 Original number
1	拉拔器 Puller	9986174
2-1	噴油嘴銅套擴張器 Puller	88800387
2-2	拆卸器墊塊 Puller ring	88800387
3-1	噴油嘴銅套安裝工具 Expander	
3-2	銅套固定桿 THREAD TAP	88880054

H.C.B-A1393

VOLVO (FM12) TRUCK INJECTOR SLEEVE REMOVER / INSTALLER KIT

VOLVO (FM12) 噴油嘴銅套拆裝工具組

5 / 20.5 / 21.5 / 2.02'

- This tool is designed for installing and removing sleeve.
- This tool needs to combine with H.C.B-B1350
- Application: VOLVO FM 12 Truck

- 工具是用來拆卸及安裝噴油嘴銅套
- 此工具要配合 H.C.B-B1350 一起使用
- 適用車種：VOLVO FM 12 Truck

VIDEO



PART NO.:85124276
零件型號 :85124276



PART NO.:85104134
零件型號 :85104134

A1393-1



A1393-2



A1393-3



H.C.B-C1393

VOLVO (FM/ FM12/ FH) TRUCK INJECTOR SLEEVE REMOVAL/ INSTALLATION TOOL KIT

VOLVO (FM/ FM12/ FH) 卡車噴油嘴銅套拆裝工具組

VIDEO



C1393=A1393+B1393

- You can remove/ install FM/ FM12/ FH truck injector sleeve by this tool kit.
- Suitable injector sleeve genuine no.: 85124276, 85104134, 21515329
- Application: VOLVO(FM/ FM12/ FH) truck
- 使用此工具可拆裝 FM/ FM12/ FH 的 VOLVO 卡車噴油嘴
- 適用銅套料號 : 85124276, 85104134, 21515329
- 適用車種 : VOLVO(FM/ FM12/ FH) 卡車



PART NO.:85104134
零件型號 :85104134

PART NO.:85124276
零件型號 :85124276

Sleeve no:21515329

H.C.B-A1462

VOLVO (FM/ FH) INJECTOR NOZZLE PULLER

VOLVO (FM/FH) 噴油嘴拔卸工具

- This puller is designed to remove injector nozzles when injector pump is overheat and stuck.
- The slide hammer action gives a straight even pull without damaging components.
- Steps: (1)Open legs of main body and hook up with injector pump(2)then fix upper screw(3)take C base to fix with main body(4) assemble slide hammer to take out nozzle.
- Application: VOLVO FM12, FM, FH500 trucks.
- 當噴油嘴咬死難以拆卸時，使用此工具將可省時省力。
- 直立式滑槌設計於使用時不會傷及配件。
- 將工具本體兩側張開鉤在噴油嘴，並在將上方螺絲旋緊，之後將 C 型固定塊鎖緊，再接上滑槌撞擊，即可取出噴油嘴。
- 適用車種 : VOLVO FM12, FM, FH500 卡車



VOLVO Truck Fuel Injector Pump:3169521
VOLVO 卡車 噴油嘴幫浦 :3169521



H.C.B-F1560

VOLVO (FM12) (EV90/EV91) TRUCK DIFFERENTIAL MAIN SHAFT BEARING EXTRACTOR

VOLVO (FM12) (EV90/EV91) 卡車差速器主軸培林拆卸器

- Character: Normally, the removal of bearing is done by cutting, but it'll cause damage of main shaft. Using this tool kit can make the removal of bearing done quickly, safely, and prevent the bearing from damage.
- Application: VOLVO (FM12) truck
- 說明：傳統使用切割的方式拔除培林，易損壞到主軸。使用此工具在拔除差速器的培林，能快速、安全，並保持培林不受損壞。
- 適用車種：VOLVO (FM12) 卡車



VIDEO



23NUG09



Bearing no.: 243150

Extract the top bearing

H.C.B-H1560

VOLVO (FM12) (EV90/EV91) DIFFERENTIAL FRONT/ REAR MAINSHAFT BEARING REMOVAL/ INSTALLATION TOOL KIT

VOLVO (FM12) (EV90/EV91) 卡車差速器前 / 後主軸培林拆裝工具組

- Character: Normally, the removal of bearing is done by cutting, but it'll cause the damage of main shaft. Using this tool kit can make the removal of bearing done quickly, safely, and prevent the bearing from damage.
- Application: VOLVO (FM12) truck
- 說明：傳統使用切割的方式拔除培林，易損壞到主軸。使用此工具能快速、安全的拔除差速器的培林，並不會損壞培林。
- 適用車種：VOLVO (FM12) 卡車

VIDEO



Main shaft of the differential gear



23NUG09

Bearing no.: 243150



Extract the top bearing

H.C.B-A1609

VOLVO (FM/FH) MAIN SHAFT BEARING INSTALLER

VOLVO (FM/FH) 差速器主軸培林安裝工具

- Instruction: Put the tools on the top bearing. Use hydraulic press push the tool. Then you can finish installing the bearing.
- OEM no. ref.: 9996759
- Application: VOLVO FH/FM
- 說明：將工具放置培林上放後，利用油壓床將工具壓入，即可完成安裝動作
- 原廠料號：9996759
- 適用車種：VOLVO FH/FM

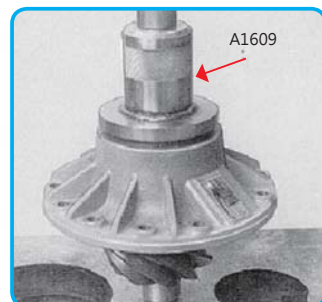

A1609

※Please use with hydraulic press.

H.C.B-A1423

VOLVO (FM12) HYDRAULIC LIFT CYLINDER REMOVAL/ INSTALLATION KIT

VOLVO (FM12) 舉升液壓缸拆裝工具

- This tool is designed for removing and installing the oil seal of hydraulic lift cylinder.
- Material: SCM 440
- Application: VOLVO (FM12) truck after 2005.

- 此工具設計用來拆裝液壓缸，來更換油封。
- 材質：SCM 440
- 適用車種：VOLVO (FM12) (2005 年之後的車)

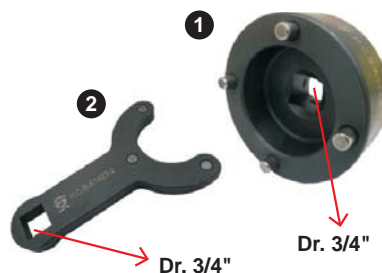

H.C.B-A1608

VOLVO (FM12/ FM/ FH) STRAIGHT LINK BALL JOINT REMOVER

VOLVO (FM12/ FM/ FH) 直拉桿球接頭拆卸工具

- Feature: This tool has a special design to apply the ball joint.
- Instruction: This tool is used to remove the end ball joint of the drag link of Volvo (FM12) (FM) (FH).
- Application: VOLVO (FM12) (FM) (FH) truck.
- OEM no. ref. : 9998758
- Operation: Put the tool to the ball joint, you can use air tool to turn the screw. Then the ball joint will be separated.

- 特色：此球接頭形狀特別，須有特殊工具才能拆卸此球接頭。
- 說明：此工具為拆卸 VOLVO 直拉桿後端球接頭。
- 操作：將工具放置欲拆除位置，可搭配氣動工具，轉動螺桿直至球接頭分離。



VIDEO

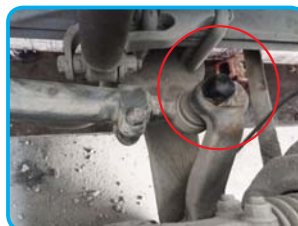

! Please remove the nut before you remove the ball joint.
放置工具前，請先拆除螺母！

H.C.B-A1614

VOLVO (FM12/ FM) FRONT/REAR STABILIZER BALL JOINT REMOVER (43 mm)

VOLVO (FM12/ FM)

前後平衡軸吊桿球接頭拆卸工具 (43 mm)

- Function: This remover is designed to remove the ball joints of front/rear stabilizer.
- Operation: Fit this remover on the ball joint, and turn the screw on the remover to push out the upper and lower ball joint.
- OEM no. ref. : 9990814
- Application: VOLVO (FM12)(FM)



VIDEO

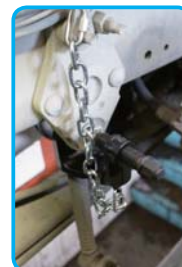

This remover allows the removal of both upper and lower ball joint of the stabilizer.



Removal of upper ball joint

Removal of upper ball joint

- 說明：此工具為拆卸前、後平衡軸吊桿的球接頭
- 操作：將工具放置球接頭位置後，轉動螺桿，即可拆卸上、下的球接頭
- 原廠號碼：9990814
- 適用車種：VOLVO (FM12) (FM)

H.C.B-A1615

VOLVO (FM) TRUCK ABS SENSOR WHEEL FITTING TOOL

VOLVO (FM) 卡車 ABS 齒環安裝工具

- Feature : This tool can install the ABS sensor with even force. Avoid bad installation.
- Instruction : This tool designed to install ABS sensor. Without tool, it may appears ABS fault light if you did a bad installation.
- Application : VOLVO truck
- OEM no. ref. : 9998558-3
- 特色：此工具在安裝 ABS 齒環時，齒環能平均受力，避免因施力不均導致安裝不良
- 使用說明：此工具用來安裝 ABS 感應器，若無使用此工具安裝，可能會造成汽車 ABS 故障燈亮起。
- 適用車種：VOLVO 卡車 ■ 原廠料號：9998558-3

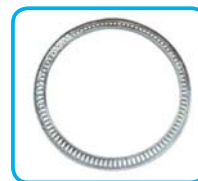
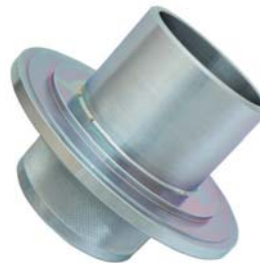

ABS sensor

H.C.B-A1616

VOLVO TRUCK FITTING TIMING GEAR COVER INSTALLER

VOLVO 卡車時規蓋安裝工具

- Feature : This tool is designed to fix gear cover. If you don't use this tools, it might cause gear cover leak oil.
- OEM no. ref. : 9998389, 9998601
- 使用說明：此工具是固定時規蓋時所需的工具。若無此工具，可能會導致時規蓋漏油。
- 原廠料號：9998389, 9998601

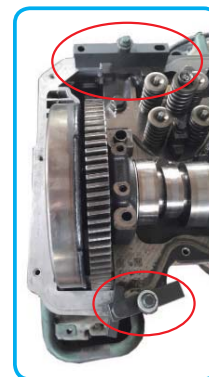

H.C.B-A1617

VOLVO TRUCK REMOVING AND FITTING TIMING GEAR PLATE TOOL

VOLVO 卡車正時齒輪板工具

- Instruction: The tools are used to replace or repair components.
- Application: VOLVO truck. Engine model: D12, D12A, D12B, D12C
- OEM no. ref.: 9998267
- 說明：此工具可用來更換或修理零組件。
- 適用車種：VOLVO 卡車
- 原廠料號：9998267

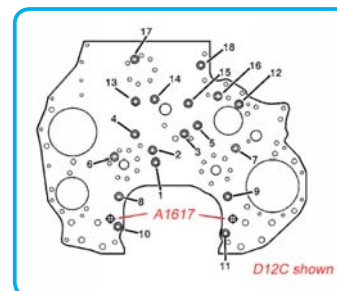

H.C.B-A1626

VOLVO (FM) TRUCK DISC BRAKE CALIPER FIXING SCREW WRENCH (Dr. 1")

VOLVO (FM) 卡車碟煞卡鉗固定螺絲扳手 (Dr. 1")

- Feature : This tool with different ends. One end is H27, it can work on the vehicle directly. The other end is Dr.1", you can lengthen it depending on the situation.
- Application : VOLVO (FM12) truck.
- OEM no. ref.: 9998573
- 特色：此工具設計有兩邊不同尺寸，一邊是 H27，可直接拆卸 / 安裝螺絲，另一邊為 Dr.1"，可視情況所需加長套筒。
- 適用車種：VOLVO (FM) 卡車
- 原廠料號：9998573



H.C.B-A1627

VOLVO (FM) TRUCK REAR WHEEL AXLE BEARING/ OIL SEAL INSTALLER

VOLVO(FM) 卡車後輪軸培林 / 油封安裝工具

- Instruction : This tool can help you install the bearing or oil seal with even force. Avoid bad installation.
- Application : VOLVO(FM) truck.
- OEM no. ref.: 88800173
- 說明：此工具用來安裝後輪軸培林及油封。在安裝培林或油封時，能平均受力，避免因施力不均，導致安裝不良。
- 適用車種：VOLVO(FM) 卡車
- 原廠料號：88800173



H.C.B-B1627

VOLVO (FM) TRUCK FRONT WHEEL AXLE BEARING/ OIL SEAL INSTALLER

VOLVO(FM) 卡車前輪軸培林 / 油封安裝工具

- Instruction : This tool can help you install the front axle bearing or oil seal with even force. Avoid bad installation.
- Application : VOLVO(FM) truck.
- OEM no. ref.: F-566426
- 說明：此工具用來安裝前輪軸培林及油封。在安裝培林或油封時，能平均受力，避免因施力不均，導致安裝不良。
- 適用車種：VOLVO(FM) 卡車
- 原廠料號：F-566426



H.C.B-C1627

VOLVO (FM) TRUCK FRONT WHEEL AXLE BEARING/ OIL SEAL INSTALLER

VOLVO (FM) 卡車舉升軸培林 / 油封安裝工具

- Instruction : This tool can help you install the bearing or oil seal with even force. Avoid bad installation.
- Application : VOLVO (FM) truck.
- OEM no. ref.: F-566427
- 說明：此工具用來安裝舉升輪軸培林及油封。在安裝培林或油封時，能平均受力，避免因施力不均，導致安裝不良。
- 適用車種：VOLVO (FM) 卡車
- 原廠料號：F-566427



H.C.B-A1646

VOLVO (FM/FH) (12 SPEED) TRANSMISSION MAINSHAFT BEARING/ GEAR REMOVAL TOOL

VOLVO (FM/FH) (12 速) 變速箱主軸培林 / 齒輪拆卸工具

- Instruction:
No.1 used to remove bearing of 12 speed transmission.
No.2 used to remove gear of 12 speed transmission.
- Clamp is required while removing.
- Application: VOLVO truck (12 Speed)
- OEM no. ref.:9998215

- 使用方法: 1 號工具用來拆卸 12 速變速箱的培林
2 號工具用來拆卸 12 速變速箱的齒輪
- 必須配合夾具使用
- 適用車種: VOLVO 卡車 12 速變速箱
- 原廠料號: 9998215

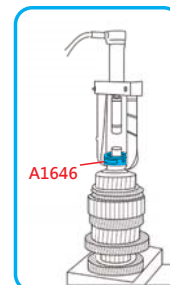

H.C.B-A1654

VOLVO (FM) OUTPUT SHAFT SEAL INSTALLER

VOLVO (FM) 變速箱後油封安裝工具

- Feature: Use this tool can install transmission rear oil seal easily and conveniently.
- Application: VOLVO (FM) truck
- OEM no. ref.: 9998575

- 特色: 此工具用來安裝變速箱後油封, 輕鬆、快速就可安裝完成
- 適用車種: VOLVO (FM) 卡車
- 原廠料號: 9998575

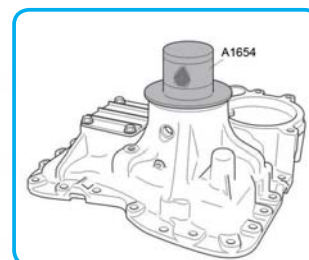

H.C.B-A1677

VOLVO TRUCK VALVE SUPPORT HANGER

VOLVO 卡車汽門支撐吊架

- Application: VOLVO D9/D11/D12/D13/D16
- Capacity: 100 KGS
- OEM no. ref.: 88800352

- 最大載重: 100 KGS
- 原廠編號: 88800352
- 適用車種: VOLVO D9/D11/D12/D13/D16

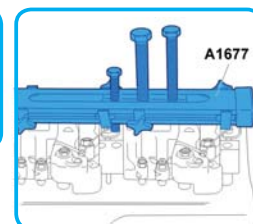

H.C.B-A1693

VOLVO TRUCK PISTON RING INSTALLATION SLEEVE

VOLVO 卡車汽缸套活塞安裝器

- Special design of cone tool makes piston ring into cylinder sleeve easily, save time and labor!
- Used to guide the piston into the cylinder sleeve during piston installation.
- OEM no. ref.: 9998006
- Application: TD122 engine
- 將此工具套在汽缸前端, 此工具的錐型設計使安裝時可順利讓活塞滑進, 節省時間與人力。
- 當安裝活塞時, 此工具用於引導所述活塞進入汽缸套。
- 原廠編號: 9998006
- 適用車種: TD122 引擎



H.C.B-B1693

VOLVO TRUCK PISTON RING INSTALLATION SLEEVE

VOLVO 卡車汽缸套活塞安裝器

- Special design of cone tool makes piston ring into cylinder sleeve easily, save time and labor!
- Used to guide the piston into the cylinder sleeve during piston installation.
- OEM no. ref. : 9996664
- Application: VOLVO TD102, TD103 engine
- 將此工具套在汽缸前端·此工具的錐型設計使安裝時可順利讓活塞滑進，節省時間與人力。
- 當安裝活塞時，此工具用於引導所述活塞進入汽缸套。
- 原廠編號 : 9996664
- 適用車種 : VOLVO TD102, TD103 引擎



H.C.B-C1693

VOLVO TRUCK PISTON RING INSTALLATION SLEEVE

VOLVO 卡車汽缸套活塞安裝器

- Special design of cone tool makes piston ring into cylinder sleeve easily, save time and labor!
- Used to guide the piston into the cylinder sleeve during piston installation.
- OEM no. ref. : 9996839
- Application: VOLVO TD71, TD73 engine
- 將此工具套在汽缸前端·此工具的錐型設計使安裝時可順利讓活塞滑進，節省時間與人力。
- 當安裝活塞時，此工具用於引導所述活塞進入汽缸套。
- 原廠編號 : 9996839
- 適用車種 : VOLVO TD71, TD73 引擎



H.C.B-D1693

NEW

VOLVO (FM 500) (EURO 5) TRUCK PISTON RING INSTALLATION SLEEVE

VOLVO (FM 500) (5 期) 卡車汽缸套活塞安裝器

- Special design of cone tool make piston ring into cylinder sleeve easily, save time and labor!
- Used to guide the piston into the cylinder sleeve during piston installation.
- Application: VOLVO (FM 500) (EURO 5) Truck
- 特殊的錐形設計讓活塞安裝更快速、省力！
- 此工具可將活塞導入汽缸套裡。
- 適用車種 : VOLVO (FM 500) (5 期) 卡車



H.C.B-A1697

VOLVO FM12 (420/430/440) TRUCK TIMING GEAR SOCKET

VOLVO FM12 (420/ 430/ 440) 卡車正時驅動齒輪套筒

- Instruction: This tool is used on timing gear.
- Application: FM12 (420/ 430/ 440)
- 說明 : 此工具用來正時齒輪
- 適用車種 : FM12 (420/ 430/ 440)



H.C.B-A1698

VOLVO FM12 (420/430/440) TRUCK CRANKSHAFT REAR OIL SEAL INSTALLATION TOOL

VOLVO FM12 (420/430/440) 卡車曲軸後油封安裝工具

- Instruction: This tool is used to prevent the crankshaft rear oil seal from damage when installing it. It is very easy to damage oil seal without using this tool.
- Application: FM12 (420.430.440)
- OEM no. ref. : 9990166, 8880013
- 說明：正確使用此工具可避免安裝後油封時損壞油封。
- 適用車種：FM12 (420.430.440)
- 原廠編號：9990166, 8880013

VIDEO

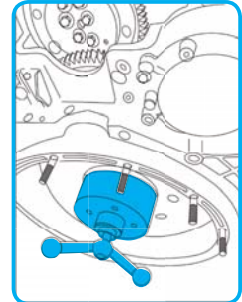

H.C.B-A1707

VOLVO (FM, FH 500P/ 540P) TRUCK CABIN SHOCK ABSORBER SPRING COMPRESSOR DE.PAT. 20 2017 101 722 TW PAT. M542590

VOLVO (FM, FH 500P/ 540P) 卡車車屋避震器壓縮工具

- Instruction: When the shock absorber leaks, you will need the tool to remove the spring compressor to change the the absorber. It can work with H.C.B-A1246.
- Application: VOLVO FM truck.
- 使用說明：當車屋前避震器減震筒漏油時，需更換減震筒。使用此工具可壓縮彈簧，輕鬆更換減震器。可配合 H.C.B-A1246 使用
- 適用車種：VOLVO FM 卡車

VIDEO



Optional: A1246
(選購)



H.C.B-B1320-052

NEW

VOLVO TRUCK SOCKET (Dr. 1", 6 POINTS, 52 mm)

VOLVO 卡車套筒 (Dr. 1", 6 角, 52 mm)

- Size: 6 points, 52 mm, Dr. 1"
- Application: VOLVO truck
- 尺寸：6 角, 52 mm, Dr. 1"
- 適用車種：VOLVO 卡車



H.C.B-B1675

NEW

VOLVO(FH/ FM/ NH)TRUCK OIL SEAL REMOVAL SLIDE HAMMER

VOLVO (FH/ FM/ NH) 卡車油封拆卸滑槌

- Remove the old seal by tapping in a puller inside the seal and pulling it out with a slide hammer
- Application: VOLVO TAD1343GE/ TAD1344GE/ TAD1345GE ENGINE
- Models: DAILY
- VOLVO OEM no.ref.:9996400, 9990192

- 使用 H.C.B-B1675 敲進舊油封，並利用滑槌將油封拉出。
- 適用車種：VOLVO TAD1343GE/ TAD1344GE/ TAD1345GE 引擎
- 型號：DAILY
- VOLVO 原廠號碼：9996400, 9990192

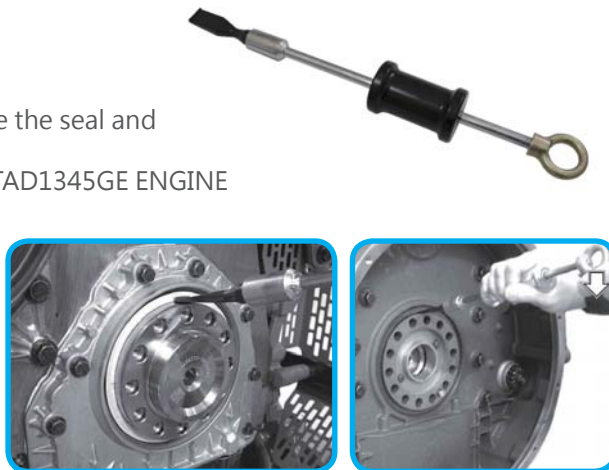

H.C.B-A1771

NEW

VOLVO (FM12) TRUCK WHEEL AXLE FRONT/ REAR (INNER, OUTER) OIL SEAL INSTALLER

VOLVO (FM 12) 卡車輪軸前 / 後 (內 / 外) 油封安裝工具

- To prevent the crankshaft rear oil seal from damaged when installing it.
- Outside oil seal genuine: 800792A
Oil seal dimension: $\text{Ø}125 \times 148 \times 9.7\text{L mm}$
- Inside oil seal genuine: 800792C
Oil seal dimension: $\text{Ø}125 \times 148.3 - \text{Ø}156.1 \times 9.3\text{L mm}$
- 若無使用特殊工具安裝油封，容易造成油封安裝不均，導致漏油，並再次重新拆卸零件，重新安裝。使用此工具可快速又準確的安裝好油封。
- 外油封料號：800792A
油封尺寸： $\text{Ø}125 \times 148 \times 9.7\text{L mm}$
- 內油封料號：800792C
油封尺寸： $\text{Ø}125 \times 148.3 - \text{Ø}156.1 \times 9.3\text{L mm}$



H.C.B-A1800

NEW

VOLVO TRUCK BEARING EXTRACTOR

VOLVO 卡車培林拆卸器

- Formerly, engineers extract the bearings by destroying the bearings. It might damage the part and the shaft. Use this tool can extract the bearing easily and won't damage the parts.
- Application: VOLVO truck
- Dimension: d: $\text{Ø}226\text{mm}$, D: $\text{Ø}249\text{mm}$

- 以往若無使用工具，會使用破壞性方法來拆卸培林，這樣容易損害到零件，使用此工具可以輕鬆拆培林，過程中不會損害到相關零件。
- 適用車種：VOLVO 卡車
- 尺寸：d: $\text{Ø}226\text{mm}$, D: $\text{Ø}249\text{mm}$

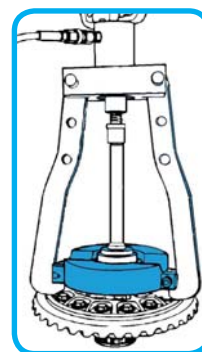

H.C.B-A1799

NEW

VOLVO TRUCK BEARING PULLER (18 TONS HYDRAULIC)

VOLVO 卡車培林拆卸器 (18 噸油壓缸)

- Formerly, engineers extract the bearings by destroying the bearings. It might damage the part and the shaft as well. Use this tool can extract the bearing easily and won't damage the parts.
- Capacity: 18 tons
- Stroke: 50 mm
- Application: Volvo FH12, FM12, FM9 truck
- Dimension of the removing ring:
d:Ø 195 mm x D:Ø 220 mm
- VOLVO OEM no. ref.: 9990074. 9809729. 9996499

- 以往若無使用工具，會使用破壞性方法來拆卸培林，這樣容易損害到零件，使用此工具可以輕鬆拆培林，過程中不會損害到相關零件。
- 油壓缸噸數：18 噸
- 行程：50 mm
- 適用車種：Volvo FH12, FM12, FM9
- 拆卸座尺寸：d：Ø 195 mm x D:Ø 220 mm
- VOLVO 原廠號碼：9990074. 9809729. 9996499

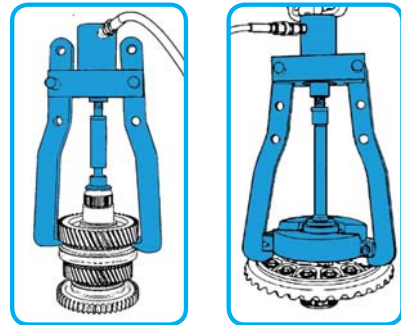

H.C.B-A1801

NEW

VOLVO TRUCK TRANSMISSION PTO REMOVER

VOLVO 卡車變速箱 PTO 拔卸器

- Special tool for removing the PTO of VLOVO truck transnission.
- Application: Volvo truck
- 在拆卸變速箱 PTO 的過程，若沒有特殊工具，過程耗時費力。
- 適用車種：Volvo 卡車



H.C.B-A1802

NEW

VOLVO TRUCK TRANSMISSION HIGH/ LOW GEAR ENGAGE TOOL

VOLVO 卡車變速箱高低檔齒合板工具

- This tool is designed to repair hight and low gear of transmission.
- Application: VOLVO truck
- 此工具用於維修變速箱高低檔齒合板
- 適用車種：VOLVO 卡車



H.C.B-A1803

NEW

VOLVO TRUCK BEARING PRESS

VOLVO 卡車培林安裝工具

- Tool for pressing the bearings onto the gear wheels.
- Application: VOLVO truck
- Volvo OEM number: 884168
- 使用 H.C.B-A1803 壓下培林，可快速將培林安裝到定位，避免相關零件損壞。
- 適用車種：VOLVO truck
- VOLVO 原廠號碼：884168

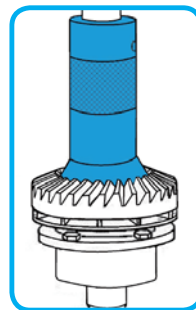

H.C.B-A1804

NEW

VOLVO TRUCK LIFTING EYE TOOL

VOLVO 卡車吊耳

- Install on the output shaft to separate the gearbox housing.
- Application: VOLVO truck
- 將此工具鎖入輸出軸的上方，即可輕鬆分離變速箱外蓋。
- 適用車種：VOLVO 卡車

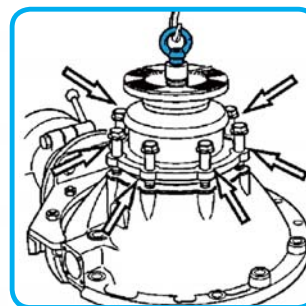

H.C.B-A1805

NEW

VOLVO TRUCK ENGINE HOUSING SEPARATOR

VOLVO 卡車引擎蓋分離器

- This tool is to split the main housing and range housing.
- Application: VOLVO FM AT2512C
- VOLVO OEM no. ref.: 9998051
- 此工具用於分離引擎外蓋，以便維修引擎內部
- 適用車種：VOLVO FM AT2512C
- VOLVO 原廠號碼：9998051

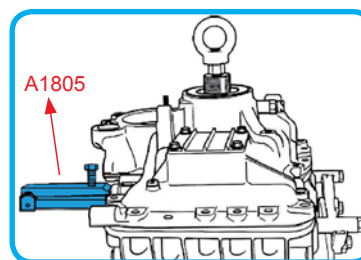

H.C.B-A1806

NEW

VOLVO TRUCK MAIN SHAFT/ COUNTER SHAFT REMOVAL/ INSTALLATION TOOL

VOLVO 卡車主 / 副軸拆裝工具

- Tool for assemble or disassemble the primary and secondary axis.
- Application: VOLVO B12, B12B, B12M, B7F, B7FA, B7L, B9M, B9F, B9S, B9F9, FH12, FM12, FM9
- VOLVO OEM no. ref.: 9996910
- 此工具用於拆卸及安裝主軸與副軸
- 適用車種：VOLVO B12, B12B, B12M, B7F, B7FA, B7L, B9M, B9F, B9S, B9F9, FH12, FM12, FM9
- VOLVO 原廠號碼：9996910

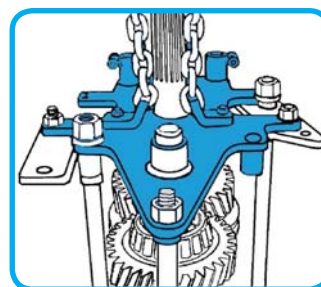

H.C.B-A1807

NEW

VOLVO TRUCK AUTOMATIC TRANSMISSION (MAIN SHAFT/COUNTER SHAFT) HIGH/ LOW GEAR ENGAGE TOOL

VOLVO 卡車自排變速箱 (主軸 / 副軸) 高低檔齒合板工具

- This tool is designed to repair high and low gear of gearbox.
- 當維修變速箱高低檔齒合板時使用此工具，可讓維修更快速簡單。



H.C.B-A1808

NEW

VOLVO TRUCK BEARING INSTALLER

VOLVO 卡車培林安裝工具

- This tool can help you install the bearing with even force. Avoid bad installation.
- Application: VOLVO truck
- 此工具用於安裝培林，可快速將培林安裝到定位，避免相關零件損壞。
- 適用車種：VOLVO 卡車



Item number 編號	d (內徑)	D (外徑)	Length (長)
A1808-1	Ø 85 mm	Ø 94.7 mm	296 mm
A1808-2	Ø 70.5 mm	Ø 88.6 mm	345 mm
A1808-3	Ø 85 mm	Ø 103.7 mm	225 mm
A1808-4	Ø 95.6 mm	Ø 113.5 mm	325 mm
A1808-5	Ø 80.8 mm	Ø 100 mm	200 mm
A1808-6	Ø 90.2 mm	Ø 109 mm	265 mm
A1808-7	Ø 66 mm	Ø 82 mm	145.5 mm
A1825	Ø 76 mm	Ø 94 mm	350 mm

H.C.B-A1810

NEW

VOLVO TRUCK THERMOSTAT SEAL INSTALLER

VOLVO 卡車節溫器油封安裝工具

- Tool for installing thermostat sealing ring on the D12C engine.
- Application: VOLVO D12C ENGINE
- VOLVO OEM no. ref.: 9998619
- 將油封安裝在其插座中，輕輕敲擊或用扳手按壓，直至油封安裝完成
- 適用車種：VOLVO D12C 引擎
- VOLVO 原廠號碼：9998619



H.C.B-A1823

NEW

BENZ ACTROS TRUCK CABIN SHOCK ABSORBER SPRING COMPRESSOR

BENZ ACTROS 卡車車屋避震器彈簧壓縮工具

- Instruction: When the shock absorber leaks, you will need this tool to remove the spring to service the shock absorber.
- Application: BENZ ACTROS truck
- 使用說明：當車屋前避震器減震筒漏油時，需更換減震筒。使用此工具可壓縮彈簧，輕鬆更換減震器。
- 適用車種：BENZ ACTROS 卡車



Part OEM number:A 943 890 03 19
零件原廠號碼 :A 943 890 03 19

H.C.B-A1824

NEW

VOLVO (FM 500) EURO 5 TRUCK BRAKE SHOES INSTALLATION TOOL

VOLVO (FM 500) 5 期卡車煞車片安裝工具

- It takes a lot of time and labor to install the brake shoes without this tool. Using A1824 to extend the brake shoes, fit the brake shoes to slave cylinder. It will help you work easily and fast!
- 在安裝煞車片時，若不使用工具，會耗費許多時間及人力，使用 A1824 可輕鬆撐開並安裝煞車片，過程快速又安全！



H.C.B-A1825

NEW

VOLVO (FM) TRUCK INPUT SHAFT BEARING INSTALLER

VOLVO (FM) 卡車輸入軸培林安裝工具

- This tool can help you install the bearing to input shaft with even force. Avoid incorrect installation.
- Application: VOLVO FM truck
- 此工具用於安裝培林，可快速將培林安裝到定位，避免相關零件損壞。
- 適用車種：VOLVO FM 卡車

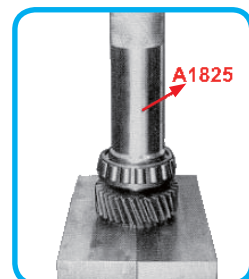

H.C.B-A1826

NEW

VOLVO (FM) TRUCK GEAR FIXING SCREW

VOLVO (FM) 卡車齒輪固定螺絲

- This tool can fix the gearwheel.
- Application: Volvo FM B12B B12M truck
- VOLVO OEM number: 9996917
- 此螺絲用於固定齒輪
- 適用車種：Volvo FM B12B B12M 卡車
- Volvo 原廠號碼：9996917

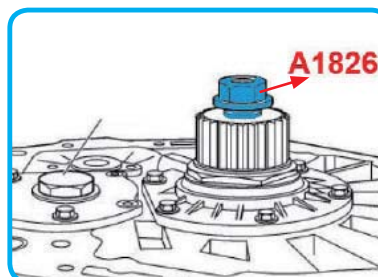

H.C.B-A1827

NEW

VOLVO (FM) TRUCK REAR AXLE BEARING INSTALLER

VOLVO (FM) 卡車後輪輪軸培林安裝工具

- This tool can help you install the rear axle bearing with even force. Avoid incorrect installation.
- Application: Volvo FM truck
- VOLVO OEM number: 9992633

- 使用 H.C.B-A1827 將培林安裝至輪軸
- 適用車種：VOLVO FM 卡車
- OEM number: 9992633

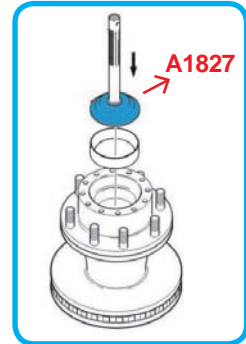

H.C.B-A1828

NEW

VOLVO (FM) TRUCK MAIN SHAFT BEARING REMOVER (18 TONS HYDRAULIC)

VOLVO (FM) 卡車主軸培林拆卸工具 (18 噸油壓缸)

- A hydraulic kit for quick and easy removal of main shaft bearing.
- Stroke: 53 mm, D: Ø 90mm, L: 175mm
- Application: Volvo FM truck
- VOLVO OEM number: 88800015/ 9998542

- 將培林固定住，即可快速將培林拆卸下
- 行程：53mm, D: Ø 90mm, 總長：175mm
- 適用車種：VOLVO FM 卡車
- Volvo 原廠號碼：88800015/ 9998542

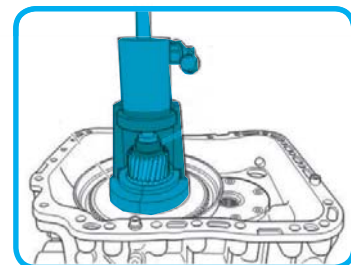
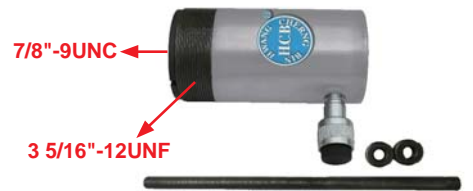

H.C.B-A1829

NEW

VOLVO INPUT SHAFT BEARING REMOVER

VOLVO 輸入軸軸承拆卸工具

- Instruction : This tool can help you install the bearing with even force. Avoid bad installation.
- Size of the bearing: 70x150x40
- OEM number: 1656129/ 722073010 ; SKF BT1B329012/Q ; FAG 574368 ; INA 722073010

- 說明：此工具用來安裝培林。安裝培林時，能平均受力，避免因施力不均，導致安裝不確實。
- 培林尺寸：70x150x40
- OEM 號碼：1656129/ 722073010 ; SKF BT1B329012/Q ; FAG 574368 ; INA 722073010



H.C.B-A1830

NEW

VOLVO (FM) TRUCK MAIN SHAFT BEARING INSTALLER

VOLVO (FM) 卡車主軸培林安裝工具

- This tool can help you install the bearing to main shaft with even force. Avoid incorrect installation.
- Application: VOLVO FM, FH12, FM10, FM12, FM7, FM9 truck.
- OEM number: 9992624

- 使用 H.C.B-A1830 可快速將培林安裝回主軸上
- 適用車種：VOLVO FM, FH12, FM10, FM12, FM7, FM9 卡車
- 原廠號碼：9992624



H.C.B-A1831

NEW

VOLVO (FM) TRUCK INPUT SHAFT BEARING REMOVER

VOLVO (FM) 卡車輸入軸培林拆卸工具

- Fixing H.C.B-A1831 onto the bearing, then use vise to resist A1831. Press the hydraulic press to press down the input shaft until the bearing is removed.
- Application: VOLVO FM, B12B, B12M, B7R, B9R
- OEM number: 9998022

- 將 H.C.B-A1831 固定在培林上後，使用老虎鉗抵住 A1831，利用壓床壓下輸入軸，即可將培林拆卸完成。
- 適用車種：VOLVO FM, B12B, B12M, B7R, B9R
- 原廠號碼：9998022



H.C.B-A1833

NEW

VOLVO (FM) TRUCK INPUT SHAFT BEARING REMOVER

VOLVO (FM) 卡車輸入軸培林拆卸座

- Fix H.C.B-A1833 onto the bearing, use the vise to resist A1833. Press down the tool. Then the bearing will be removed.
- Application: VOLVO F10, F12, FH12, FL10, FL12, FL7, FM10, FM12, FM7, NH12, NL10, NL12
- OEM number: 9998192.

- 將 H.C.B-A1833 固定在培林上後，使用老虎鉗抵住 A1833，利用壓床壓下輸入軸，即可將培林拆卸完成。
- Application: VOLVO F10, F12, FH12, FL10, FL12, FL7, FM10, FM12, FM7, NH12, NL10, NL12.
- 原廠號碼：9998192



H.C.B-B1838

NEW

VOLVO (FM 440/ 500/ FH 540) TRUCK AUTOMATIC TRANSMISSION REAR MAIN SHAFT GEAR REMOVER (18 TONS HYDRAULIC)

VOLVO (FM 440/500/ FH 540) 卡車
自排變速箱後主軸齒盤拆卸工具 (18 噸油壓式)

- Hook the tool onto the gear, install the ring to the main body. And drive the cylinder to pull out the gear. This tool designed for hydraulic. It make repair quickly and save time.
- Application: VOLVO (FM 440/ 500/ FH 540) truck, Renault 43 DXI
- 利用工具勾槽勾住齒盤，裝上固定環，使用油壓缸，即可將快速拆下齒盤。此工具為油壓設計，讓拆卸過程更方便、快速
- 適用車種：VOLVO (FM 440/500/ FH 540) 卡車自排變速箱，Renault 43 DXI



H.C.B-A1838

NEW

VOLVO (FM 440/ 500/ FH 540) TRUCK AUTOMATIC TRANSMISSION REAR MAIN SHAFT GEAR REMOVER

VOLVO (FM 440/500/ FH 540) 卡車自排變速箱後主軸齒盤拆卸工具

- Hook the tool onto the gear, install the ring to the main body. And turn the spindle to pull out the gear.
- Application: VOLVO (FM 440/ 500/ FH 540) truck, Renault 43 DXI
- 利用工具勾槽勾住齒盤，裝上固定環，轉動螺絲，即可將快速拆下齒盤。
- 適用車種：VOLVO (FM 440/500/ FH 540) 卡車自排變速箱，Renault 43 DXI



H.C.B-A1454

DAF CF85 43 TONS TRAILER DRIVE SHAFT SOCKET (EURO 4 & EURO 5) (Dr. 3/4")

DAF CF85 43 噸拖車頭傳動軸套筒
(四期、五期環保車) (Dr. 3/4")

- Use the torque wrench to control the nut to tightem or loosen bearing.
- Material: SCM440.
- Application: DAF TRUCK
- 使用扭力扳手來控制螺帽，以鎖緊或鬆開培林
- 材質：SCM440.
- 適用車種：DAF 卡車



Dr. 3/4"

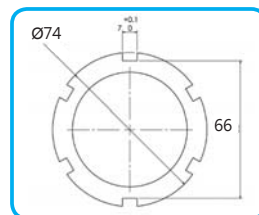

NUT SIZE

H.C.B-A1521

DAF (LF) 12/17 TONS OIL FILTER WRENCH (EURO 4/5) (Dr. 1/2", 10 FLUTES, 92 mm)

DAF (LF) 12/17 噸 (4/5 期) 機油芯扳手
(Dr. 1/2", 10 角, 92 mm)

- Size: 92 mm × 10 FLUTES × Dr. 1/2"
- Application: DAF (LF) 17 TONS OIL FILTER WRENCH (EURO 4/5)
- 尺寸: 92 mm x 10 角 x Dr. 1/2"
- 適用車種: DAF (LF) 17 TONS (EURO 4/5 期)
- 原廠料號: 1399494

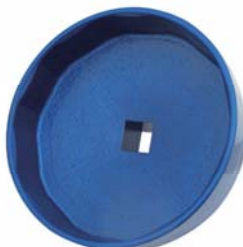

H.C.B-A1190

DAF STEERING LINKAGE FIXING BASE SOCKET (Dr. 1/2")

DAF 卡車方向機連桿固定座
拆裝套筒 (Dr. 1/2")

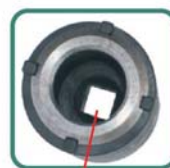

Dr. 1/2

NUT SIZE

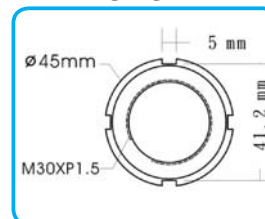

H.C.B-B1663

DAF (CF) TRUCK 35 TONS DIFFERENTIAL MAINSHAFT BEARING REMOVAL/ INSTALLATION TOOL KIT

DAF (CF) 卡車 35 噸差速器主軸培林拆裝工具組

- Instruction: This tool kit is to remove and install the main shaft bearing of DAF (CF) 35 tons truck differential.
- Application: DAF (CF) 35 tons truck.
- 說明: 此工具可拆裝 DAF (CF) 35 噸卡車差速器主軸培林
- 適用車種: DAF (CF) 35 噸卡車



Remove the big bearing
of mainshaft:
拆除主軸大培林:

Remove the big bearing
of mainshaft:
拆除主軸大培林:

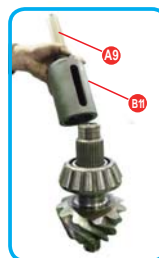

H.C.B-C1663

DAF (CF) TRUCK 35 TONS DIFFERENTIAL FRONT/ REAR, MAINSHAFT BEARING REMOVAL/ INSTALLATION TOOL KIT

DAF (CF) 卡車 35 噸差速器前 / 後, 主軸培林拆裝工具組

- Instruction: This tool kit is to remove / install the main shaft bearing and remove / install the front / rear bearing of DAF (CF) 35 tons truck differential.
- Application: DAF (CF) 35 tons truck
- 說明：此工具可拆裝 DAF (CF) 35 噸的差速器前、後培林與主軸培林
- 適用車種：DAF (CF) 35 噸卡車



Remove the differential front bearing:
拆卸差速器前培林

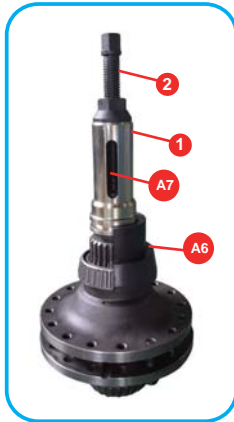

Remove the differential rear bearing:
拆卸差速器後培林

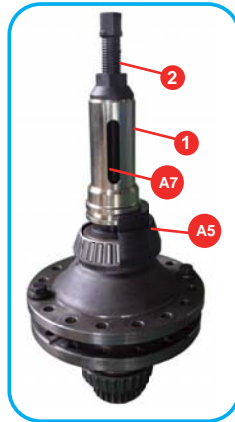

Install the differential front bearing:
安裝差速器前培林

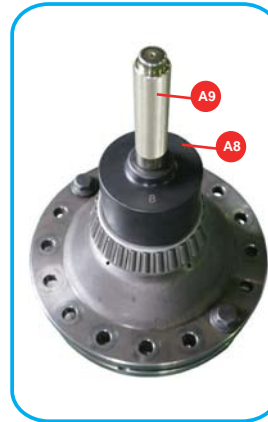

Install the differential rear bearing:
安裝差速器後培林

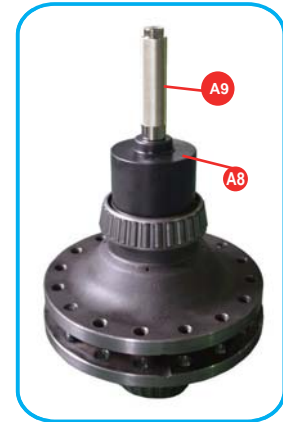

Remove the big bearing of mainshaft:
拆除主軸大培林:



Remove the inner sleeve of mainshaft:
拆除主軸培林內套管:



Install the big bearing of mainshaft:
安裝主軸大培林:



Install the inner sleeve of mainshaft:
安裝主軸培林內套管:



H.C.B-A1663

DAF (CF) TRUCK 35 TONS DIFFERENTIAL FRONT/ REAR BEARINGS REMOVAL/ INSTALLATION TOOL

DAF (CF) 卡車 35 噸差速器前後培林拆裝工具組

- Instruction: This tool is to remove and install the front/ rear bearing of DAF (CF) 35 tons truck differential.
- 說明：此工具可拆裝 DAF (CF) 35 噸差速器的前後培林
- 適用車種：DAF (CF) 35 噸卡車



Removal

Installation



H.C.B-B1465

DAF PISTON RING INSTALLATION SLEEVE (460 P) (EURO 4/5)

DAF 汽缸套活塞安裝器 (460P) (4/5 期)

- Special design of cone tool make piston ring into cylinder sleeve easily, save time and labor!
- Used to guide the piston into the cylinder sleeve during piston installation.
- Application: DAF (460 P) (EURO 4/5)
- 將此工具套在汽缸前端，此工具的錐型設計使安裝時可順利讓活塞滑進，節省時間與人力。
- 當安裝活塞時，此工具用於引導所述活塞進入汽缸套。
- 適用車種：DAF (460 P) (4/5 期)



H.C.B-A1465

DAF PISTON RING INSTALLATION SLEEVE

DAF 汽缸套活塞安裝器

- Special design of cone tool make piston ring into cylinder sleeve easily, save time and labor!
- Used to guide the piston into the cylinder sleeve during piston installation.
- 將此工具套在汽缸前端，此工具的錐型設計使安裝時可順利讓活塞滑進，節省時間與人力。
- 當安裝活塞時，此工具用於引導所述活塞進入汽缸套。



H.C.B-A1244

DAF TRUCK FLYWHEEL ROTATOR (35-42 TONS) (EURO 3)

DAF 卡車曲軸飛輪轉動器 (35-42 噸) (三期環保)

- The tool is designed for rotating crankshaft for timing.
- Application: DAF (35-42TONS) (Euro 3) truck.

- 此工具用來轉動曲軸飛輪校正正時
- 適用車種：DAF 35-42 噸卡車



H.C.B-A1716

ZF TRANSMISSION LOCATING PINS PULLER

ZF 變速箱固定銷拉拔器

- Instructions: The locating pin is in a concealed position. When you disassemble the transmission, you need to pull out the location pin first. With this tool, maintenance procedure is accelerated without damaging related parts.
- Application: ZF (12/16 speed) transmission

- 使用說明：此固定銷隱藏在隱密的位置，當維修分解變速箱時，需先將固定銷拔出。使用此工具，可加快維修速度，且不傷害到相關零件。
- 適用車種：ZF (12/16 速) 變速箱



H.C.B-A1398

DAF TRUCK FLYWHEEL ROTATOR (35-42 TONS) (EURO 4)

DAF 卡車曲軸飛輪轉動器 (35-42 噸) (四期環保)

- The tool is designed for rotating crankshaft for timing.
- Application : DAF (35-42 TONS)(Euro 4)

XF 105 (Euro 5) truck

- 此工具用來校正正時。
- 適用車種：DAF 35~42 噸 (四期環保)
XF105(五期環保) 的卡車

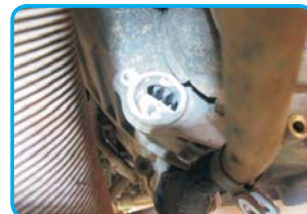

H.C.B-A1271

DAF 卡車變速箱拆裝吊具 (ZF 16 速)

- Application: European truck---DAF
Japanese truck---HINO
- 適用車種：歐系 ---DAF
日系 ---HINO

H.C.B-A1271-A

DAF TRUCK TRANSMISSION ASSEMBLY
REMOVAL/INSTALLATION TOOL KIT (ZF 16S)

DAF 卡車變速箱拆裝吊具 (ZF 16 速)

- Assists to take transmission main shaft, counter shaft and gear shift lever apart all together.
- 可將變速箱主軸、副軸和齒輪軸桿一起吊出。

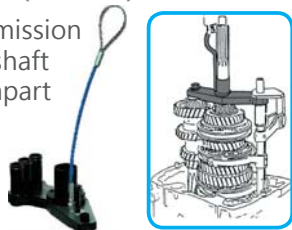

DAF TRUCK TRANSMISSION ASSEMBLY
REMOVAL/INSTALLATION TOOL KIT (ZF 16S)



H.C.B-A1271-B

DAF TRUCK TRANSMISSION MAINSHAFT
AND COUNTER SHAFT FIXED SEAT (ZF 16S)

DAF 卡車變速箱主副軸固定座 (ZF 16 速)

- Put main shaft, counter shaft and gear shift lever on this fixation to prevent damage.
- 將變速箱主軸、副軸和齒輪軸桿放在本固定座上，以避免損壞。



H.C.B-A1271-E

DAF TRUCK TRANSMISSION PLANETARY
GEAR RETAINING BOLT (ZF 16S)

DAF 卡車變速箱主軸撥叉螺栓 (ZF 16 速)

- This tool helps to install and extract transmission main shaft smoothly.
- 用來協助順利拆裝變速箱主軸。



H.C.B-A1271-C

DAF TRUCK PLANETARY GEAR GROUP
SUPPORTING PLATE (ZF 16S)

DAF 卡車變速箱缸體支撐板 (ZF 16 速)

- Before assembling the planetary gear train, use this tool to test if the block leakage or not while the piston acting.
- 在組裝行星齒輪前，用本工具測試活塞動作時，有沒有漏氣的狀況。

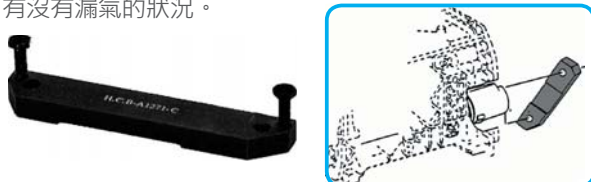

H.C.B-A1271-F

DAF TRUCK TRANSMISSION MAINSHAFT
BEARING INSTALLER (ZF 16S)

DAF 卡車變速箱主軸培林安裝器 (ZF 16 速)



Ø102x96x274 mm(L)

H.C.B-A1271-G

DAF TRUCK TRANSMISSION MAINSHAFT
BEARING INSTALLER (ZF 16S)

DAF 卡車變速箱主軸培林安裝器 (ZF 16 速)



Ø96 x 90 x 204 mm(L)

H.C.B-A1271-D

DAF TRUCK TRANSMISSION PLANETARY
GEAR ASSEMBLY SLING (ZF 16S)

DAF 卡車變速箱行星齒輪總成吊具 (ZF 16 速)

- This tool is designed for helping lift the transmission planetary gear.
- 用本工具來協助抬起行星齒輪。



H.C.B-A1271-H

DAF TRUCK TRANSMISSION MAINSHAFT
BEARING INSTALLER (ZF 16S)

DAF 卡車變速箱主軸培林安裝器 (ZF 16 速)

- H.C.B-A1271-F&G&H: assists to push the bearing into main shaft.
- H.C.B-A1271-F&G&H 可將培林壓入主軸內。



Ø93x 77 x 194 mm (L)

H.C.B-B1271

TRUCK TRANSMISSION / BEARING / SHAFT SLEEVE / GEAR PULLER SET (ZF16S)

卡車變速箱 / 培林 / 軸套 / 齒輪拆卸工具組 (ZF 16 速)

■ Features:

The best tool for removing ZF16S transmission, bearing, shaftsleeve and gear and won't damage the bearing, shaft sleeve, gear and related parts.

Easy to use. Save time and money!

■ Technical information:

Choose appropriate accessory before operation.

Put accessory puller into right place of bearing, shaft sleeve or gear, then slip fix ring on main body, and then fix screw on double ends, finally take out spare part by rotating central bolt.

■ Application: European truck-DAF, Japanese truck-HINO ZF 16S151-16S181

■ 特性：

移除 ZF16 速變速箱、培林、軸套、齒輪的最佳工具，不會損壞培林、軸套、齒輪及相關零件。方便使用！省時及省錢。

■ 使用方法：

操作前請選擇合適的配件。

拆卸時將拆卸塊放置於培林、軸套或齒輪的正確位置，再將本體套上固定環，兩端螺絲旋緊，之後轉動中心螺桿就可取出。

■ 適用車種：歐系 -DAF, 日系 -HINO ZF 16S151-16S181



Bearing stock number: FAG 575194



Bearing stock number: SKF 4395/2/QL7C VQ492

H.C.B-C1271

TRUCK TRANSMISSION / BEARING / SHAFT SLEEVE / GEAR PULLER KIT (ZF16S221-16S251)

卡車變速箱 / 培林 / 軸套 / 齒輪拆卸工具組 (ZF16S221-16S251)

■ Feature:

This tool is used to divide the transmission main shaft, bearing sleeve and gear of ZF 16 speed.

When the bearing or gear is damaged, you can use this tool to divide them from the shaft. It can help you work efficiency and save time.

■ 說明：

此工具是用來分解 ZF16 速變速箱主軸、培林軸套、齒輪

當變速箱主軸上，有培林、齒輪損壞時，就可用此套工具來拆卸，省時，有效率



VIDEO



H.C.B-A1432

DAF TRANSMISSION NEUTRAL POSITION ADJUSTMENT TOOL

DAF 變速箱空檔位置校正器

- Used to adjust the neutral position of transmission.
- H.C.B-A1432-1 is for adjusting the control-rods in the upper part of transmission.
- H.C.B-A1432-2 is for adjusting the selector shafts of transmission.
- Application: DAF Tiptronic truck (EURO 3.4.5)
- 此工具用來調整變速箱空檔位置。
- H.C.B-A1432-1 用來校正變速箱上蓋的推桿
- H.C.B-A1432-2 調整變速箱本體檔位
- 適用車種：DAF(三、四、五期環保)手自排卡車

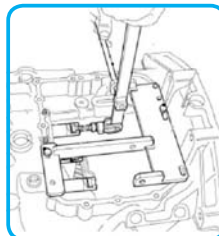

H.C.B-A1718

ZF STEP ENTRANCE BUS HUB REMOVAL/ INSTALLATION TOOL KIT

ZF 低底盤巴士輪軸拆裝工具組

- This tool kit can disassemble the hub, wheel axle, nut..., etc for all the process of regular service and maintenance.
- 說明：日常維護和保養時，可使用此工具套組來進行整個保養流程。此工具組可分解輪軸，拆卸輪軸、螺母...等工作。



H.C.B-A1572

DAF (CF) DRIVE AXLE NUT SOCKET(EURO 5) (Dr. 1", 6 POINTS, 120 mm)

DAF (CF) 5 期環保帶動軸螺帽套筒 (Dr. 1", 6 角, 120 mm)

- To remove the drive axle nut.
- Application: DAF EURO 5
- Size: Dr. 1", 6 POINTS, 120 mm
- 使用此工具來移除帶動軸螺母。
- 適用車種：DAF EURO 5
- 尺寸：Dr. 1", 6 角, 120 mm

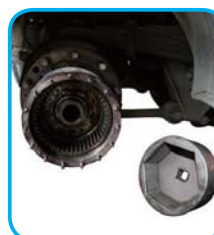
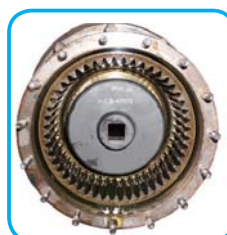
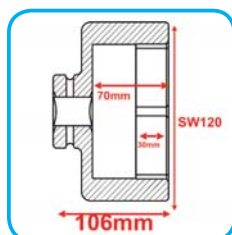
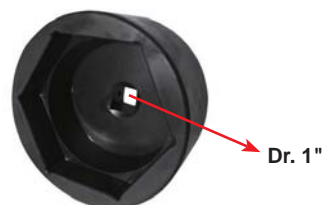

H.C.B-A1602

DAF TRUCK DIFFERENTIAL V TORSION BAR BUSH REMOVAL / INSTALLATION TOOL KIT (70 mm)

DAF 卡車差速器 V 型扭力桿鐵套拆裝工具組 (70 mm)

■ Feature:

This tool kit allows the removal and installation of the center/end bushings of DAF truck differential V type torsion rod.

※Require hydraulic system when removing/installing.

■ 說明：此工具用於拆卸及安裝 DAF 卡車差速器 V 型扭力桿之中心及兩端鐵套

※ 須使用油壓工具進行拆裝

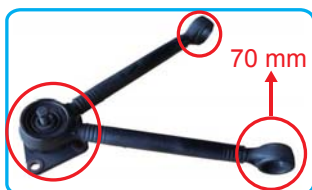

VIDEO



Part no: 1861038

Part no: 1676776



H.C.B-B1602

DAF TRUCK DIFFERENTIAL V TORSION BAR BUSH REMOVAL / INSTALLATION TOOL KIT (75 mm)

DAF 卡車差速器 V 型扭力桿鐵套拆裝工具組 (75 mm)

■ Feature:

This tool kit allows the removal and installation of the center/end bushings of DAF truck differential V type torsion rod.

※Require hydraulic system when removing/installing.

■ 說明：此工具用於拆卸及安裝 DAF 卡車差速器 V 型扭力桿中心及兩端 75 mm 鐵套

※ 須使用油壓工具進行拆裝



H.C.B-A1409

DAF XLR (EURO 4) PROPELLER SHAFT CENTER BEARING NUT SOCKET

DAF 四期 XLR 傳動軸中間軸承固定套筒

- To remove and install the nut of propeller shaft center bearing when bearing is broken.
- The robust socket is manufactured from a piece of material.
- Material : SCM440, Net Weight: 0.786 kgs
- It can be used with torque wrench for installing and removing about 350 N.m.
- Application: DAF XLR (Euro 4) Truck

- 當培林損壞時，用來拆除及安裝傳動軸中間軸承螺帽。
- 採一體成型的設計
- 材質：SCM440 重量：0.786 kgs
- 搭配扭力扳手使用，約 350 N.m
- 適用車種：DAF 四期環保 XLR 卡車

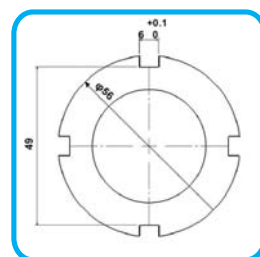

H.C.B-A1636

DAF (CF 85) CRANKSHAFT FRONT OIL SEAL INSTALLER (35-43 TONS) (EURO 4/5)

DAF (CF 85) 曲軸前油封安裝器 (35-43 噸) (4/5 期環保)

- Oil seal OEM no. ref. : 1684105=1876189
- Application: DAF(CF 85) 35-43 tons (Euro 4/5) truck. (360/ 410 /460)
- Oil seal size: 134x161x16 mm

- 油封料號：1684105=1876189
- 適用車種：DAF (CF 85) 35-43 噸 (4/5 期環保) 卡車，360/ 410 /460
- 油封尺寸：134x161x16 mm



油封號碼：
1684105=1876189



Part no:1684105



H.C.B-B1636

DAF (CF 85) TRUCK CRANKSHAFT REAR OIL SEAL INSTALLER (35-43 TONS) (EURO 4/5)

DAF (CF 85) 卡車曲軸後油封安裝器 (35-43 噸) (4/5 期環保)

- To prevent the crankshaft rear oil seal from damaged while installing it.
- Application: DAF (CF85) (35-43 tons) 360/ 410/ 460
- Oil seal genuine no.: 1876190=1684106
- Oil seal size: 16 × 166 × 191 mm

■ 說明：若無使用特殊工具安裝油封，容易造成油封安裝不均，因而導致漏油，需要再次拆卸及安裝油封。使用此工具可快速且準確的安裝好油封。

■ 適用車種：DAF (CF85) (35-43 噸) 360/ 410/ 460

■ 油封料號：1876190=1684106

■ 油封尺寸：16 × 166 × 191 mm



油封號碼：
1684106=1876190



H.C.B-A1678

DAF 12 TONS (LF45) TRUCK REAR AXLE NUT SOCKET

DAF 12 噸 (LF45) 卡車後輪輪軸螺帽套筒

- Fix bearing while removing or installing the truck nut.
- Use the air wrench or rod to control the nut to tighten or loosen bearing.
- Application: DAF (LF 45) 12 tons

■ 說明：更換培林時，需使用本工具鬆開輪軸螺帽。

■ 使用氣動扳手或扳桿來控制螺帽，以鎖緊或鬆開培林。

■ 適用車種：DAF (LF 45) 12 噸

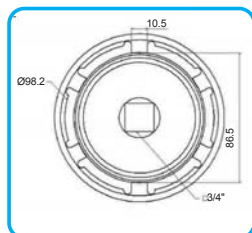

H.C.B-A1679

DAF 17 TONS (LF55/ CF65) TRUCK TRANSMISSION INPUT SHAFT OIL SEAL INSTALLER

DAF 17 噸 (LF55/ CF65) 卡車變速箱輸入軸油封安裝工具

- Instructions: Due to the convex of front gear of input shaft, it won't be possible to install the new oil seal if this tool is unavailable. This tool is designed to pass the front gear for installing the oil seal accurately back to its place.
- Application: DAF 17 tons (LF55), DAF 17 tons (CF65)

■ 說明：因輸入軸前齒輪凸出，若沒有使用工具，將無法安裝油封。

■ 此工具經設計，可避過前齒輪，將油封平整安裝至定位。

■ 適用車種：DAF 17 噸 (LF55), DAF 17 噸 (CF65)



H.C.B-A1682

DAF 17 TONS (LF55/ CF65) TRUCK CRANKSHAFT FRONT OIL SEAL INSTALLER

DAF 17 噸 (LF55/ CF65)
卡車曲軸前油封安裝工具

VIDEO



- To prevent the crankshaft front oil seal from damaged while installing it.
- Application: DAF 17 TONS (LF55)
DAF 17 TONS (CF65)
- Oil seal size: L12 × Ø70 × Ø100 mm
- Oil seal no. ref.: 4890832
- 說明: 若無使用此特殊工具安裝油封, 容易造成油封安裝不均, 若導致漏油, 則需要再次拆卸及安裝油封。使用此工具可快速又準確的安裝好油封。
- 適用車種: DAF 17 TONS (LF55)
DAF 17 TONS (CF65)
- 油封尺寸: L12 × Ø70 × Ø100 mm
- 油封料號: 4890832

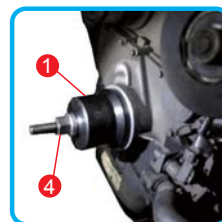

Oil seal no. ref.: 4890832

H.C.B-A1685

DAF (CF) (17/ 35/ 43TONS) DRIVE SHAFT BEARING INSTALLER

DAF (CF) (17/ 35/ 43 噸) 帶動軸培林安裝工具

- Instruction: This tool can help you install the bearing with even force to avoid uneven force causing improper installation.
- Bearing no.: F-566283.01-H195 L.100-184255 L.101-053736
- 說明: 此工具用來安裝培林。安裝培林時, 能平均施力, 以避免因施力不均, 而導致安裝不確實。
- 培林編號: F-566283.01-H195 L.100-184255 L.101-053736



H.C.B-B1685

DAF (CF) (26 TONS) FRONT AXLE BEARING INSTALLER

DAF (CF) (26 噸) 前輪軸培林安裝工具

- Instruction: This tool can help you install the bearing with even force. Avoid improper installation.
- Bearing no.: F-566193-H195
- 說明: 此工具用來安裝培林。安裝培林時, 能平均施力, 以避免因施力不均, 而導致安裝不確實。
- 培林編號: F-566193-H195



H.C.B-C1685

DAF (CF) (17/ 35/ 43 TONS) FRONT AXLE / LIFT AXLE BEARING INSTALLER

DAF (CF) (17/ 35/ 43 噸) 前輪軸 / 舉升軸培林安裝工具

- Instruction: This tool can help you install the bearing with even force. Avoid improper installation.
- Bearing number: F-566074-H195/ L.071-174110
/L.072-031741
- 說明: 此工具用來安裝培林。安裝培林時, 能平均受力, 避免因施力不均, 導致安裝不確實。
- 培林編號: F-566074-H195/ L.071-174110
/L.072-031741



H.C.B-C1402

DAF (CF85) VALVE SPRING COMPRESSOR TOOL KIT (EURO 4/5)

DAF (CF85) 汽門彈簧壓縮工具組 (4/5 期)

- Application: DAF (CF 85)(Euro 4/5)
- Engine: 410/ 460
- Injector genuine no.: 1905001
- 適用車種 : DAF (CF 85)(4/5 期)
- 引擎型號 : 410/460
- 噴油嘴料號 : 1905001

Notice: Place valves and springs in a marked rack to facilitate reinstallation at the same place in the cylinder head.

注意：在氣門彈簧原本的位置做上記號，以便能將氣門彈簧安裝回相同位置。

Screw the top nut on the injector.
Latch it on the hammer. Strike it until the injector removed.

使用方法：將工具本體前端螺絲鎖在噴油嘴，接上滑鎚，撞擊即可將噴油嘴取出

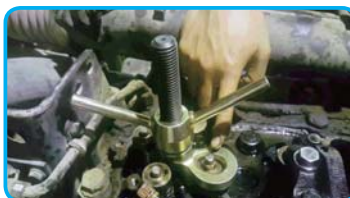

H.C.B-A1562

DAF(CF 85) COMPRESSOR REAR SEAT BEARING FIX BOLT SOCKET (11 RIBS)

DAF(CF 85) 空壓機後座培林固定螺絲套筒 (11 齒)

- Use for remove the bolt of compressor rear seat bearing.
- Application: DAF (CF) 85
- Size: Dr. 1/2", 65 mm(L), 11 ribs
- 用於拆除空壓機後座培林固定螺絲
- 適用車種 : DAF (CF) 85
- 尺寸 : Dr. 1/2", 65 mm (L), 11 齒



H.C.B-A1753

NEW

DAF 12 TONS (LF45) FRONT AXLE NUT SOCKET (Dr. 1")

DAF 12 噸 (LF 45) 前輪軸螺帽套筒 (Dr. 1")

- Instruction: When you change the bearing, you need this tool to loosen the nut of axle.
- Work with air wrench/ wrench to loosen or tighten the bearing.
- Application: DAF (LF 45) 12 tons
- 說明：更換培林時，需使用本工具鬆開輪軸螺帽。
- 使用氣動扳手或扳桿來控制螺帽，以鎖緊或鬆開培林。
- 適用車種 : DAF (LF 45) 12 噸

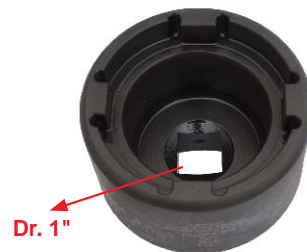

H.C.B-A1242

BENZ ACTROS PITMAN ARM PULLER (Dr. 3/4", 42 mm)

BENZ ACTROS 卡車方向機搖臂拆卸器 (Dr. 3/4", 42 mm)

6 / 27 / 28 / 1.32'

- Save time and labor.
- No need to destroy the pitman arm.
- Application: Benz Actros & MAN 414

- 省時省力。
- 不需破壞方向機搖臂。
- 適用車種：Benz 卡車 Actros & MAN 414 球接頭



H.C.B-A1263

TRUCK POSITION SENSOR SOCKET (Dr. 1/2", 8 POINTS, 27 mm)

卡車位置感應器套筒 (Dr. 1/2", 8 角, 27 mm)

- For removing / replacing truck position sensor.
- Material: SCM440, HRC: 30°~35°
- Length: 60 mm
- The tool is not allowed to work with air wrench.
- Application: Mercedes-Benz commercial vehicles SK series, Actros, MAN commercial vehicles, SCANIA, ZF 16 speeds gear box.

- 可用來移除 / 更換卡車位置感應器
- 材質：SCM440 · 硬度：30°~35°
- 長度：60 mm
- 本工具不可與氣動扳手一起使用。
- 適用車種：Mercedes-Benz 卡車 SK 系列 · Actros · MAN 商務車 · SCANIA, ZF 16 速卡車。



H.C.B-A1314

BENZ & MAN TRUCK FRONT AXLE NUT SOCKET (Dr. 3/4", SW 60 mm, 76 mm)

BENZ & MAN 卡車前輪軸螺帽套筒
(Dr. 3/4", SW 60 mm, 76 mm)

- Specifications: Dr. 3/4" x SW 60 mm x 76 mm
- Application:
MAN and BENZ 9 tons strengthen front axle VL5, Benz SK front axle VL5/1 D-9, VL5/2 D-9, series 2629/6x4, 2635 K/6x4, 3535 K8/x4/4, such as Benz Actros with disc brake and FAUST 9 tons front axle.

- 規格：Dr.3/4" x SW 60 mm x 76 mm
- 適用車種：
MAN 和 Benz 9 噸卡車的強化前軸 VL5
Benz SK 前軸 VL5/1 D-9, VL5/2 D-9, 2629/6x4, 2635 K/6x4, 3535 K8/x4/4 系列。
如：配備碟剎的 Benz Actros 及 FAUST 9 噸的前軸。



H.C.B-B1314

BENZ & MAN TRUCK FRONT AXLE NUT SOCKET (Dr. 3/4", SW 56 mm, 71 mm)

BENZ & MAN 卡車前輪軸螺帽套筒
(Dr. 3/4", SW 56 mm, 71 mm)

- Specification: Dr. 3/4" x SW 56 mm x 71 mm
- Application:
DAF, BENZ trucks (axles VL 3/8, 13, VO 3/10, VL 4/7, 9, 10, VD 4/14, VO 4/11, 13, 18, VL4/15, 16, 19 and VD 4/20 in type 363, 385, 387, 389, 391, 393, 395, 617, 620, 621, 622, 623, 625 and 649 (ex: BENZ ACTROS with drum brake tightening nut no. 652 330 00 88) BENZ buses (axles VO 3/10, 4/11, 4/13 and 4/19 in type 0303, 0305-G and 0307) MAN trucks (with clamping nut no. 81.92901-0066) KASSBOHRER / SETRA (front axle 6,5 + 7,5 in types S210 and 215, SG 219-221 and non-driven rear axle types S216 HDS and S228 DT)

- 規格 : Dr. 3/4" x SW 56 mm x 71 mm
- 適用車種 :

DAF, BENZ 卡車 (系列 363, 385, 387, 389, 391, 393, 395, 617, 620, 621, 622, 623, 625 和 649 的車軸 VL 3/8, 13, VO 3/10, VL 4/7, 9, 10, VD 4/14, VO 4/11, 13, 18, VL 4/15, 16, 19 and VD 4/20 (如 :BENZ 的 ACTROS 鼓煞鎖定螺帽編號 652 330 00 88) BENZ 遊覽車 (系列 0303, 0305-G 和 0307 的車軸 VO 3/10,4/11, 4/13 和 4/19) MAN 卡車 (鎖定螺帽編號 81.92901-0066) KASSBOHRER / SETRA 系列 (S210 和 S215, SG 219-221 的前軸 6,5 和 7,5 · S 216 HDS 和 S 228 DT 的非帶動後軸



H.C.B-A1384

BENZ TRUCK TRANSMISSION OIL LEVEL GAUGE

BENZ 卡車變速箱機油尺

- For measuring the oil level of transmission.
- Application: BENZ truck
- 可用來測量變速箱的油量
- 適用車種 : BENZ 卡車



H.C.B-A1832

NEW

BENZ (2845/ 2846/ 2858) TRUCK AUTOMATIC TRANSMISSION ADJUSTER

BENZ (2845/ 2846/ 2858) 自排變速箱調整器工具

- Designed to maintain BENZ (2845/ 2846/ 2858) truck automatic transmission.
- 特殊設計用於維修 BENZ (2845/ 2846/2848) 的自排變速箱



H.C.B-A1441

BENZ TRUCK (2640) DRIVE AXLE NUT SOCKET (Dr. 3/4", 6 TEETH)

BENZ 卡車 (2640) 帶動軸螺帽套筒 (Dr. 3/4", 6 齒)

- The unique design and profile of the socket make it perfectly flush in position and prevent the damage of axle nut.
- Fix bearing while removing or installing the truck nut.
- Use the torque wrench to control the nut to tighten or loosen bearing.
- Material:SCM440.
- Application:BENZ TRUCK (2640) DRIVE AXLE.

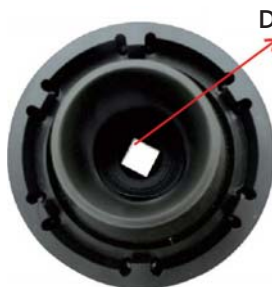

Dr.3/4"

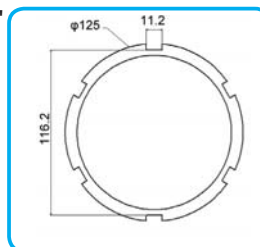

NUT SIZE

- 特殊的設計使套筒能精準卡住輪軸螺帽，避免輪軸螺帽的損壞。
- 移除或安裝卡車帶動軸螺帽時，需使用本工具來固定培林。
- 使用扭力扳手來控制螺帽，以鎖緊或鬆開培林。
- 材質：SCM440
- 適用車種：賓士卡車 (2640) 帶動軸



H.C.B-A1442

BENZ TRUCK (2640) LIFT AXLE NUT SOCKET (Dr. 3/4", 6 TEETH)

BENZ 卡車 (2640) 舉升軸螺帽套筒 (Dr. 3/4", 6 齒)

- The unique design and profile of the socket make it perfectly flush in position and prevent the damage of axle nut.
- Fix bearing while removing or installing the truck nut.
- Use the torque wrench to control the nut to tighten or loosen bearing.
- Material:SCM440.
- Application:BENZ TRUCK (2640) LIFT AXLE.



Dr.3/4"

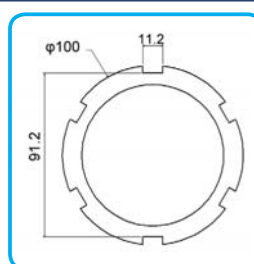

NUT SIZE

- 特殊的設計使套筒能精準卡住輪軸螺帽，避免輪軸螺帽的損壞。
- 移除或安裝卡車舉升軸螺帽時，需使用本工具來固定培林。
- 使用扭力扳手來控制螺帽，以鎖緊或鬆開培林。
- 材質：SCM440
- 適用車種：賓士卡車 (2640) 舉升軸



H.C.B-A1443

BENZ TRUCK WHEEL AXLE NUT SOCKET (Dr. 1")

BENZ 卡車輪軸螺帽套筒 (Dr. 1")

- Used to removing or installing
- Application: BENZ truck
- 用來拆裝卡車輪軸螺帽
- 適用車種：BEZN truck



Dr.1"

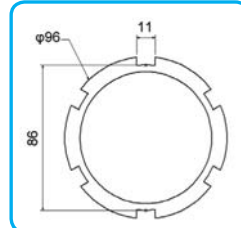

NUT SIZE

H.C.B-A1387

BENZ AXLE NUT SOCKET (H36, 12 POINTS, 95 mm)

BENZ 輪軸螺帽套筒 (H36, 12 角, 95mm)

6 / 19.4 / 20 / 1.41'

- The size of drive nut is 6 points, 36 mm.
- Suited to male nut in the axle.
- It can be used with impact wrench or torque wrench.
- Size: H36, 12 points, 95 mm
- Application: BENZ Trailer

- 套筒上帶動螺帽的尺寸為外 6 角 · 36 mm.
- 可拆卸輪軸上的螺帽。
- 可搭配衝擊扳手或扭力扳手一起使用。
- 尺寸：H36, 12 角, 95mm
- 適用車種：Benz 拖車



H.C.B-B1387

IVECO AXLE NUT SOCKET (H36, 12 POINTS, 110 mm)

IVECO 輪軸螺帽套筒 (H36, 12 角, 110mm)

6 / 18 / 18.5 / 1.41'

- The size of drive nut is 6 points, 36 mm.
- Suited to male nut in the axle.
- It can be used with impact wrench or torque wrench.
- Size: H36, 12 points, 110 mm
- Application: IVECO Eurotech-Cursor

- 套筒上帶動螺帽的尺寸為外 6 角 · 36 mm.
- 可拆卸輪軸上的螺帽。
- 可搭配衝擊扳手或扭力扳手一起使用。
- 尺寸：H36, 12 角, 110mm
- 適用車種：IVECO Eurotech-Cursor

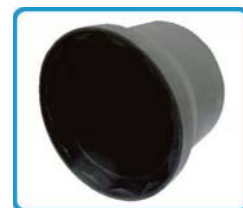

SWmm	Hex	Ø mm	H
110	36	133	116

H.C.B-C1387

IVECO AXLE NUT SOCKET (H36, 12 POINTS, 105 mm)

IVECO 輪軸螺帽套筒 (H36, 12 角, 105 mm)

- The size of drive nut is 6 points, 36 mm.
- Suited to male nut in the axle.
- It can be used with impact wrench or torque wrench.
- Size: H36, 12 points, 105 mm
- Application: IVECO Eurotech-Cursor lorries

- 可搭配氣動扳手與扭力扳手使用
- 尺寸：H36, 12 角, 105 mm
- 適用車種：IVECO Eurotech-Cursor lorries



H.C.B-A1411-95

BENZ AXLE NUT SOCKET (H36, 6 POINTS, 95 mm)

BENZ 輪軸螺帽套筒 (H36, 6 角, 95 mm)

6 / 18 / 19 / 1.27'

- The unique design and profile of the socket make it perfectly flush in position and prevent the damage of axle nut
- The robust socket is manufactured from a piece of material.
- It can be used with impact wrench or torque wrench for installing and removing.
- Material: SCM440.
- Size: H36, 6POINTS, 95 mm, L: 157 mm
- Application: Mercedes Benz axle trailers.

- 特殊的設計使套筒能精準卡住輪軸螺帽，避免輪軸螺帽損壞。
- 此套筒採一體成型的設計。
- 可搭配衝擊扳手或扭力扳手一起使用。
- 材質：SCM440
- 尺寸：H36, 6 角, 95 mm, 長度：157 mm
- 適用車種：Mercedes Benz axle trailers.



H.C.B-A1411-98

IVECO AXLE NUT SOCKET (H36, 6 POINTS, 98 mm, Dr. 3/4")

IVECO 輪軸螺帽套筒 (H36, 6 角, 98 mm, Dr. 3/4")

6 / 18 / 19 / 1.27'

- The unique design and profile of the socket make it perfectly flush in position and prevent the damage of axle nut
- The robust socket is manufactured from a piece of material.
- It can be used with impact wrench or torque wrench for installing and removing.
- Material: SCM440.
- Size: H36, 6 POINTS, 98 mm, L: 115 mm, Dr. 3/4"
- Application: IVECO Euro Cargo etc...

ISUZU 15 Tons Truck (263) rear wheel axle nut.

- 特殊的設計使套筒能精準卡住輪軸螺帽，避免輪軸螺帽損壞。
- 此套筒採一體成型的設計。
- 可搭配衝擊扳手或扭力扳手一起使用。
- 材質：SCM440
- 尺寸：H36, 6 角, 98 mm, 長度：115 mm, Dr. 3/4"
- 適用車種：IVECO Euro Cargo etc...

ISUZU 15 噸卡車 (263) 後輪輪軸螺帽



Dr. 3/4"

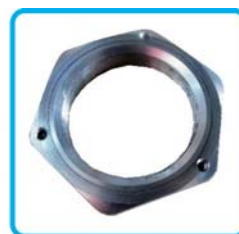

ISUZU 15 TONS TRUCK (263)

H.C.B-A1601

IVECO 3.5/7 TONS OIL FILTER WRENCH (Dr. 1/2", 10 FLUTES, 94.5 mm)

IVECO 3.5/7 噸機油芯扳手 (Dr. 1/2", 10 角, 94.5 mm)

6 / 18 / 19 / 1.27'

- Size: 94.5 mm × 10 FLUTES × 1/2" DRIVE
- Application: IVECO 3.5 tons and 7 tons
- 尺寸：94.5 mm × 10 FLUTES × 1/2" DRIVE
- 適用車種：IVECO 3.5 噸和 7 噸



H.C.B-A1561

IVECO WHEEL NUT SOCKET (Dr. 1", 12 POINT, 85 mm)

IVECO 輪軸螺帽套筒 (Dr. 1", 12 角, 85 mm)

- Polygonal wrench for hubs- IVECO.
 - Axle nut disassembly
 - Polygon 85 mm
 - Inner Ø 83 mm - Square 1"
 - Application: IVECO
-
- 尺寸: 12 角, 85 mm, Dr. 1, 內徑 Ø 83 mm
 - 適用車種: IVECO

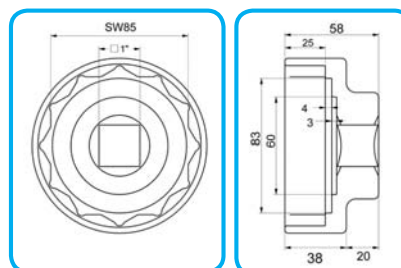

H.C.B-A1603

IVECO 3.5/ 7 TONS TIRE NUT CROSS WRENCH (27 mm)

IVECO 3.5/7 噸輪胎螺絲十字扳手 (27 mm)

- Feature: This tool is used to remove/ install the rear/ front tire nuts of IVECO 3.5 tons and 7 tons truck.
 - Application: IVECO 3.5 tons and 7 tons truck
-
- 說明: 此工具可拆 / 裝 IVECO 3.5 噸和 7 噸前、後輪胎螺絲
 - 適用車種: IVECO 3.5 噸和 7 噸卡車



H.C.B-A1740

IVECO (12/17 TONS) STEERING MECHANISM NUT WRENCH

IVECO (12/17 噸) 方向機螺帽扳手

- During the service procedure, if the removal of steering column is required, this wrench can directly remove the nut of steering column in narrow space without the need of disassembling the other parts to access the nut which significantly simplify the sophisticated process of removal of steering column.



- 在維修過程中，若需要拆卸方向機，使用此扳手，讓你能在狹小的空間內將方向機螺母拆卸下，而不需要將周邊的零件，省去複雜的過程，即可將方向機拆卸完成。

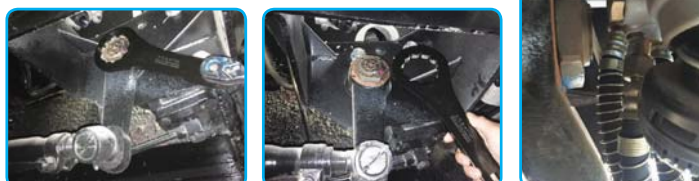

H.C.B-A1618

IVECO DUAL GEAR ENGINE FLYWHEEL ROTATOR (WITH 2 GEARS)

IVECO DUAL 齒輪引擎飛輪轉動器 (2 齒)

- Designed for dual gear engine flywheel rotation for timing .
- Suitable for IVECO models
- Engine models: 8360.46 / F3A / F3B
- Application: Euro Cargo / Cargo 150E27R PR / FPR 320E27T / PT Eurotech / Eurostar models
- 此工具設計用於轉動引擎飛輪以利正時。
- 引擎代號：8360.46 / F3A / F3B
- 適用車種：IVECO Euro Cargo / Cargo 150E27R PR / FPR 320E27T / PT Eurotech / Eurostar models



H.C.B-A1634

RENAULT MAGNUM TRUCK/ CAT ENGINE BARRING ENGINE FLYWHEEL ROTATOR (Dr.1/2")

RENAULT MAGNUM/ CAT 卡車引擎飛輪轉動器 (Dr.1/2")

- Tool for engine flywheel rotation during the tappets adjustment
- Application: RENAULT MAGNUM/CAT
- 此工具用來校正曲軸正時
- 適用車種：RENAULT MAGNUM/CAT



H.C.B-A1280

YORK REAR WHEEL NUT SOCKET (8 POINTS, 95 mm)

YORK 後輪螺帽拆裝套筒 (8 角, 95 mm)

- Fix bearing while removing or installing the truck nut.
- Use the air wrench or rod to control the nut to tighten or loose bearing
- 在拆卸或安裝卡車螺帽時，用來固定培林。
- 以氣動扳手或扳桿調整螺帽，以控制培林的鬆緊度。



H.C.B-A1422

BENZ TRUCK FILTER WRENCH (46 mm)

BENZ 卡車機油芯套筒 (46 mm)

- To remove the oil filter of BENZ truck.
- The robust socket is manufactured from a piece of material.
- It can be used with torque wrench for installing and removing.
- Size: 6 points, 46 mm Dr. 3/8"
- Material: SCM440
- Application: BENZ TRUCK ACTROS, ATEGO, AXOR AND ECONIC....



- 用來拆裝 BENZ 卡車機油芯
- 套筒採一體成型的設計
- 可搭配扭力扳手一起使用
- 尺寸：6 角，46 mm, Dr. 3/8"
- 材質：SCM440
- 適用車種：BENZ 卡車 ACTROS, ATEGO, AXOR AND ECONIC....

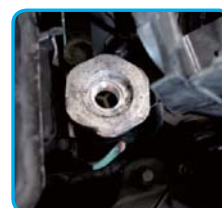

H.C.B-A1282

YORK ROTATING AXLE SHAFT TIE ROD BUSH REMOVAL / INSTALLATION TOOL KIT

YORK 自動軸橫拉桿鐵套拆裝工具組

- Safe removal/ replacement of YORK rotating axle shaft tie rod bush.
- The kit can be easily operated with H.C.B-B3036(Air Pump).
- 使用本工具組安全拆卸 / 更換 YORK 自轉軸鐵套。
- 可搭配 H.C.B-B3036(氣動幫浦) 一起使用。



Bush



Extraction



Installation

H.C.B-A1283

FUWA WHEEL SHAFT COVER SOCKET (Dr.1", 8 POINTS, 123 mm)

福華板車輪軸蓋拆裝套筒 (Dr. 1", 8 角, 123 mm)

- The socket for extracting / installing wheel shaft cover.
- Application: FUWA
- 可拆卸及安裝板車輪軸蓋。
- 適用車種：FUWA



Dr. 1"



H.C.B-A2178

TRUCK INJECTION NOZZLE SOCKET

卡車噴油嘴拆裝套筒

- This tool is for removing and installing diesel injection nozzle.
- Loosen nut of injection nozzle by A2178-1, tighten the center bolt by using A2178-2 and then remove nozzle.
- Application: Man (422.403), Benz Truck, Scania
- 可拆卸及安裝柴油噴油嘴
- 使用 A2178-1 轉開噴油嘴螺帽, 再以 A2178-2 鎖緊噴油嘴中心螺絲, 拉出噴油嘴。
- 適用車種：Man(422.403), Benz Truck, Scania



H.C.B-A2212

TRUCK INJECTOR SOCKET KIT (4 PCS)

卡車噴油嘴套筒組 (4 PCS)

- For removing and installing the injector of truck.
- 使用本工具組移除及安裝卡車的噴油嘴。
- Specification:

	A2212-1	A2212-2	A2212-3 (A2178)	A2212-4 (A1071)
	H32	Dr. 1/2"	H32 & H24	Dr. 1/2"
Inner Ø (mm) 內徑	22.5	23	22	22.2
Outer Ø (mm) 外徑	28.5	30	28.5	28.5
Long (mm) 長度	122	122	84.5	72
Weight (g) 重量	260	168	164	280
Teeth 齒數	4	3	4	4
Material 材質	S45C	SCM 440	S45C	SCM 400
Applicable 適用車種	Benz Euro 2 engine, MAN Benz 二期環保引擎, MAN	Benz, Man	Benz, MAN (403, 422) and Scania	Benz, MAN (403, 422) and Scania
Description 說明	<ul style="list-style-type: none"> Open and Permeable type To extract the cable from the needle motion sensors 開口、可穿過式 可移除針狀動做感應器的電線 		<ul style="list-style-type: none"> For diesel engine. Thread size of H24: M14xP1.5 適用於柴油引擎 H24 尺寸: M14xp1.5 	<ul style="list-style-type: none"> For diesel engine. 適用於柴油引擎



H.C.B-A2222

DIESEL INJECTOR SOCKET KIT (4 PCS)

柴油噴油嘴套筒組 (4 PCS)

10 / 11.4 / 12.4 / 0.8'

Item No. 編號	Description 規格	Diameter 直徑	Length 長度
A2222-1	12 points socket 12 角套筒	28 mm	78 mm
A2222-2	12 points socket 12 角套筒	27 mm	78 mm
A2222-3	12 points socket 12 角套筒	22 mm	80 mm
A2222-4	6 points socket 6 角套筒	22 mm	110mm

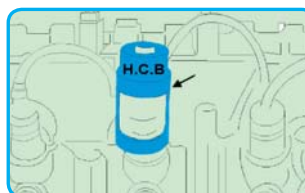

- Four Chrome Vanadium open-sided Dr. 1/2" sockets for diesel injector removal and installation.
- Application: Alfa Romeo, Chrysler, BMW, Ford, VW, Mercedes-Benz, AUDI, OPEL, Vauxhall, Seat, VOLVO, ROVER, MAN 2.5TD, SCANIA HGVS and Peugeot
- 四支 Dr. 1/2" 鉻鈦鋼材質開口套筒，可用來移除和安裝柴油噴油嘴。
- 適用車種：Alfa Romeo, Chrysler, BMW, Ford, VW, Mercedes-Benz, AUDI, OPEL, Vauxhall, Seat, VOLVO, ROVER, MAN 2.5TD, SCANIA HGVS 和 Peugeot

H.C.B-A1390

EUROPEAN TRUCK DISC BRAKE CALIPER SOCKET (Dr. 3/8", 11 TEETH)

歐系卡車碟煞卡鉗套筒 (Dr. 3/8", 11 齒)

- For removing / installing disc brake caliper of European trucks.
- Size: Dr. 3/8", 11 teeth, 26 mm/L
- Application: European trucks, such as VOLVO, RENAULT, SCANIA, DAF

- 用來拆裝歐系卡車的碟煞卡鉗。
- 尺寸：Dr. 3/8" · 11 齒 · 26 mm/ 長
- 適用車種：歐系卡車。如：VOLVO, RENAULT, SCANIA, DAF



H.C.B-A1403

BPW (12 TONS) TRAILER OIL SEAL INSTALLER

BPW 12 噸板車輪軸油封安裝器

- To prevent the oil seal from damage when installing. It is very easy to damage oil seal without using this tool.
- Due to the special smooth surface design, the force on oil seal can be average when installing.
- Application: BPW 12 TONS TRAILER
- Oil Seal Genuine no.: MOAY 134.94 159.55 12.7

- 正確使用此工具可避免安裝時損壞油封。
- 如果未使用此工具，在更換時容易損壞到油封。
- 此工具特殊平滑的設計，使在安裝油封時能平均受力。
- 適用車種：BPW 12 噸板車
- 油封料號：MOAY 134.94 159.55 12.7

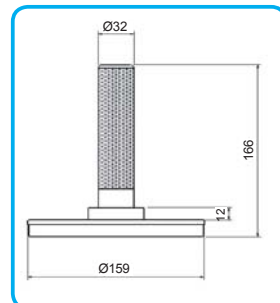

OIL SEAL : MOAY 134.94 159.55 12.7
油封料號 : MOAY 134.94 159.55 12.7

H.C.B-A1434

LIEBHERR CRANE WHEEL SOCKET (Dr. 1")

LIEBHERR 吊車輪軸蓋套筒 (Dr. 1")

- For removing and installing the wheel cover.
- Material: SCM440
- Application: LIEBHERR CRANE

- 用來拆裝輪軸蓋的套筒
- 材質：SCM440
- 適用車種：
LIEBHERR 吊車



H.C.B-A1404

ROR TRAILER REAR WHEEL NUT SOCKET (Dr. 1" , 8 POINT, 83 mm, 3 1/4") (DRUM BRAKE)

ROR 板車輪軸螺帽套筒 (鼓式剎車)(Dr. 1" , 8 角 , 83 mm,3 1/4")

- Remove the rear wheel nut of ROR trailer to change the bearing.
- The robust socket is manufactured from a piece of material.
- It can be used with torque wrench for installing and removing.
- Material: SCM440
- Size: Dr. 1" , 8 POINTS, 3 1/4" , 83 mm
- Application: ROR TM series Trailer wheel nut.
- 用來拆裝 ROR 板車輪軸螺帽 · 來更換培林
- 此套筒採一體成型的設計
- 可搭配扭力扳手一起使用
- 材質 : SCM440
- 尺寸 : Dr. 1" , 8 角 , 3 1/4" , 83 mm
- 適用車種 : ROR TM 系列板車輪軸

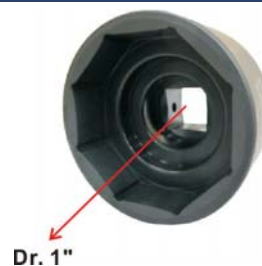

Dr. 1"

H.C.B-B1488-120

ROR REAR WHEEL HUB NUT SOCKET (DISC BRAKE) (Dr. 1" , 8 POINT, 120 mm)

ROR 板車輪軸螺帽套筒 (碟式煞車)(Dr. 1" , 8 角 , 120 mm)

- For removing the rear wheel nut of ROR trailer to change the bearing.
- Size: Dr. 1" , 8 POINTS, 120 mm
- Application: ROR TM series Trailer rear wheel nut.
- 用來拆裝 ROR 板車輪軸螺帽 · 來更換培林
- 尺寸 : Dr. 1" , 8 角 , 120 mm
- 適用車種 : ROR TM 系列板車輪軸



Dr. 1"

Item	Dr.	SW	Item	Dr.	SW	Application
A1488-70	3/4"	70mm	B1488-70	1"	70mm	
A1488-75	3/4"	75mm	B1488-75	1"	75mm	
A1488-80 (B1125)	3/4"	80mm	B1488-80 (C1125)	1"	80mm	SCANIA FRONT WHEEL
A1488-85	3/4"	85mm	B1488-85	1"	85mm	TOYOTA TRUCK UNDER 8.5 TONS(REAR WHEEL)
A1488-90	3/4"	90mm	B1488-90	1"	90mm	
A1488-95	3/4"	95mm	B1488-95	1"	95mm	HINO 10.4-11TON
A1488-100 (B1126)	3/4"	100mm	B1488-100 (C1126)	1"	100mm	SCANIA REAR WHEEL
A1488-105	3/4"	105mm	B1488-105	1"	105mm	
A1488-110	3/4"	110mm	B1488-110	1"	110mm	
A1488-115	3/4"	115mm	B1488-115	1"	115mm	
A1488-120	3/4"	120mm	B1488-120	1"	120mm	HINO,FUSO REAR WHEEL HINO 17,21,25,35,42 TON
A1488-125	3/4"	125mm	B1488-125	1"	125mm	
A1488-130	3/4"	130mm	B1488-130	1"	130mm	
A1488-135	3/4"	135mm	B1488-135	1"	135mm	
A1488-140	3/4"	140mm	B1488-140	1"	140mm	
A1488-145	3/4"	145mm	B1488-145	1"	145mm	
A1488-150	3/4"	150mm	B1488-150	1"	150mm	
A1488-155	3/4"	155mm	B1488-155	1"	155mm	
A1488-160	3/4"	160mm	B1488-160	1"	160mm	
A1488-165	3/4"	165mm	B1488-165	1"	165mm	
A1488-170	3/4"	170mm	B1488-170	1"	170mm	
A1488-175	3/4"	175mm	B1488-175	1"	175mm	
A1488-180	3/4"	180mm	B1488-180	1"	180mm	
A1488-185	3/4"	185mm	B1488-185	1"	185mm	
A1488-190	3/4"	190mm	B1488-190	1"	190mm	
A1488-195	3/4"	195mm	B1488-195	1"	195mm	
A1488-200	3/4"	200mm	B1488-200	1"	200mm	



ROR WHEEL HUB NUT

H.C.B-A1482

BENZ REAR AXLE NUT SOCKET (Dr. 3/4", 105-125 mm)

BENZ 後輪軸螺帽套筒 (Dr. 3/4", 105-125 mm)

- Fix bearing while removing and installing rear axle nut.
- It can be used with torque wrench for installing and removing.
- Material: SCM440.
- Application: Mercedes Benz Actros Rear axle HL/HL 8 (Hypoid).

■ 當拆裝後輪軸螺帽時用來固定培林

■ 拆和裝時候 · 可使用扭力扳手

■ 材質 : SCM440

■ 適用車種 : Mercedes Benz Actros Rear axle HL/HL 8 (Hypoid).



ITEM	Inner Ømm	Outer Ømm	H mm	Stud Ømm	Stud width mm
A1482	105	125	180	116	10

H.C.B-A1483

BENZ&MAN REAR AXLE NUT SOCKET (Dr. 3/4", 80-95 mm)

BENZ&MAN 後輪軸螺帽套筒 (Dr. 3/4", 80-95 mm)

- Rigid locating tube.
- Optional with expander sleeve(bayonet locking).
- It can be used with torque wrench for installing and removing.
- Application: Mercedes Benz Atego Rear axle, Vitaro 814, MAN, etc

■ 堅固定位管

■ 可選擇的擴展套 (缺口鎖定)

■ 可以搭配扭力扳手使用

■ 適用車種 : Mercedes Benz Atego Rear axle, Vitaro 814, MAN, etc



ITEM	Inner Ømm	Outer Ømm	Locating tube Ømm	H mm	Stud Ømm	Stud width mm
A1483	80	95	49	175	87	10

H.C.B-A1922

NEW

BENZ REAR AXLE NUT SOCKET (Dr.3/4",101.5mm,12 POINTS)

BENZ 後輪軸螺帽套筒 (Dr.3/4", 101.5mm, 12 角)

- Fix bearing while removing and installing rear axle nut.
- It can be used with torque wrench for installing and removing.
- Material: SCM440.
- Size: Inner 101.5 mm, Outer 110mm
- Application: BENZ Truck
- BENZ OEM no.ref.: 740589000700

■ 此工具可在拆裝後輪軸螺帽時固定培林

■ 可搭配扭力扳手一起使用來進行拆裝

■ 材質 : SCM440.

■ 尺寸 : 內徑 101.5 mm, 外徑 110mm

■ 適用車種 : BENZ Truck

■ 原廠編號 : 740589000700



H.C.B-A1448

SAF BUSH REMOVAL/ INSTALLATION TOOL KIT

SAF 鐵套拆裝工具組

- Use this tool can remove and install the bush with less labor and time.

⚠ DO NOT use an impact wrench to turn the pivot bushing replacement tool.

- 使用此工具能輕鬆拆裝 SAF 鐵套，節省許多人力與時間
- 注意：請勿使用氣動工具



H.C.B-A1466

SAF WHEEL SHAFT COVER SOCKET (Dr. 1", 8 POINTS, 130 mm)

SAF 輪軸蓋拆裝套筒 (Dr. 1", 8 角, 130 mm)

- For extracting the wheel cover.
- Applicator: SAF
- 用來拆除輪軸蓋
- 適用車種：SAF

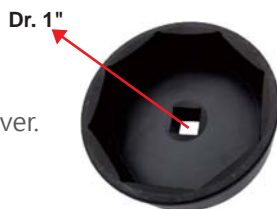

H.C.B-A1868

NEW

SAF AXLE BRAKE DISC NUT SOCKET (Dr. 1/2", 12 POINTS, 13 mm)

SAF 輪軸碟盤螺帽套筒 (Dr. 1/2", 12 角, 13 mm)

- Designed for loosening and tightening the brake disc nuts on SAF axles.
- Size: Dr. 1/2", 12 points, 13 mm, Length: 38 mm
- Application: HGVs with SAF axle.

- 此套筒用於拆裝 SAF 輪軸上的碟盤螺帽
- 尺寸：Dr. 1/2", 12 角, 13 mm, 長度：38 mm
- 適用車種：HGVs 搭載 SAF 輪軸。



H.C.B-A1492

BENZ & MAN FLYWHEEL ROTATING TOOL (WITH 2 GEARS) (Dr. 1/2")

BENZ & MAN 卡車飛輪轉動工具 (2 齒) (Dr. 1/2")

- Flywheel rotating tool with 2 gear wheels. H: 90 mm Dr. 1/2"
- This tool is used to allow precise positioning of the crankshaft for timing purposes.
- It can be operated with socket wrenches, open or ring wrenches.
- Application range:
Mercedes Benz 6-/8-and 10-cylinder engines.
Used on Mercedes trucks models 400 e.g. engines OM 401, 402, 403, 407, ACTROS, as well as for all MAN 12-cylinder engines.

- 尺寸：飛輪轉動正時工具 (2 齒輪) H：90 mm, Dr. 1/2"
- 此工具用來校正曲軸正時。
- 可搭配套筒，扳手使用。
- 適用範圍：

賓士 6-/8- 及 10 汽缸引擎

使用於賓士卡車 400 例如引擎 OM 401,402,403,407,ACTROS 及 MAN 12 汽缸引擎



H.C.B-A1493

BENZ & MAN FLYWHEEL ROTATING TOOL (WITH 3 GEARS) (Dr. 1/2")

BENZ & MAN 卡車飛輪轉動工具 (3 齒) (Dr. 1/2")

- Flywheel rotating tool with 3 gear wheels. Size: H : 120 mm, Dr. 1/2"
- This tool is used to allow precise positioning of the crankshaft for timing purposes.
- It can be operated with socket wrenches, open or ring wrenches.
- Application :
Used on Mercedes trucks models 900 e.g. engines 904 and 906 ACTROS and ATEGO, as well as for all MAN engines. MAN number 80-99626-6006 (Not for 12-cylinder engines.) MAN 5-/6- and 8-cylinder engines - D25/28..., etc.



- 飛輪轉動正時工具 (3 齒輪), 尺寸 : H: 120 mm, Dr. 1/2"
- 此工具用來校正曲軸正時。
- 可搭配套筒、扳手使用。
- 適用車種 :
賓士卡車型號 900 · 例如 : 引擎 904 及 906 ACTROS 和 ATEGO ·
也適用於所有 MAN 引擎。MAN 編號 80-99626-6006 (不適用 12 汽缸引擎。)
MAN 5-/6- 和 8 汽缸引擎 -D25-D28... 等。

H.C.B-A1494

MAN FLYWHEEL ROTATING TOOL (WITH 1 GEARS) (Dr. 1/2")

MAN 飛輪轉動工具 (1 齒) (Dr. 1/2")

- Flywheel rotating tool with 1 gear wheels.
- With this tool you can rotate the engine precise when doing valve timing or other operations
- Application range: MAN engines D20.../D25.../D26.../D28...
Flywheel rotating tool with 1 gear wheels.



- 飛輪轉動器 (1 齒) (Dr. 1/2")
- 此工具用來校正曲軸正時
- 適用範圍 : MAN 引擎 D20.../D25.../D26.../D28...

H.C.B-A1557-50

BENZ ACTROS AXLE BOLT SOCKET (32 EPL, L: 50 mm)

BENZ ACTROS 輪軸螺絲套筒 (32 EPL, L: 50 mm)

- For removing the mounting bolts of the axle on the Mercedes Benz Actros.
- Drive: 3/4", 32 EPL, L: 50 mm
- Impact resistant
- Application: MB Actros

Dr. 3/4"



Star-EP

- 適用於拆除輪軸螺絲
- 尺寸 : Drive 3/4", 32 EPL, L: 50 mm
- 可與扭力扳手一起使用
- 適用車種 : MB Actros

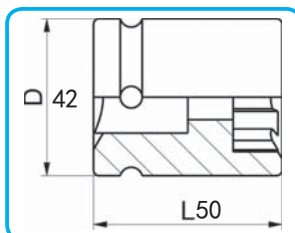

H.C.B-A1557-90

BENZ ACTROS AXLE BOLT SOCKET(32 EPL, L: 90 mm)

BENZ ACTROS 輪軸螺絲套筒 (32 EPL, L: 90 mm)

- For removing the mounting bolts of the axle on Mercedes Benz Actros.
- Drive: 3/4", 32 EPL, L: 90 mm
- Impact resistant
- Application: MB Actros
- 適用於拆除輪軸螺絲
- 尺寸：Drive 3/4", 32 EPL, L: 90 mm
- 可與扭力扳手一起使用
- 適用車種：MB Actros

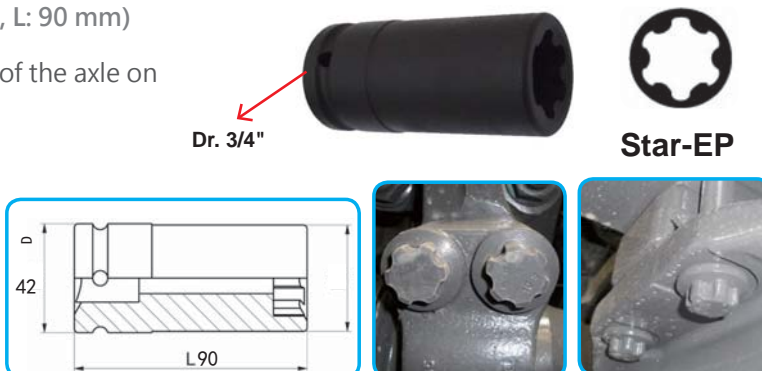

H.C.B-A2018-26

BENZ/ HINO TRUCK/ HYUNDAI UNIVERSE OIL MIST SEPARATOR WRENCH (Dr. 1/2", 12 RIBS, 96 mm)

BENZ/HINO 卡車 /HYUNDAI 巴士 油水分離器扳手
(Dr. 1/2", 12 齒 · 96 mm)

- Oil Filter no. :23414-E0020.
- Application: BENZ/HINO TRUCK
- Size: Dr. 1/2", 12 RIBS · 96 mm
- 機油芯料號：23414-E0020
- 適用車種：BENZ/HINO 卡車
- 尺寸：Dr. 1/2", 12 齒 · 96 mm



H.C.B-A1667

BENZ TRUCK LIFT SHAFT WRENCH (360 / 410 / 440 / 460 / 480 / 550)

BENZ 卡車舉升車頭扳手 (360 / 410 / 440 / 460 / 480 / 550)

- Introduction: When you service engine, you will need these tools to lift the truck head.
- Application: BENZ truck (360 / 410 / 440 / 460 / 480 / 550)
- 說明：當引擎需要維修時，需要此工具將車頭舉升，以便操作維修事項。
- 適用車種：BENZ 卡車 (360 / 410 / 440 / 460 / 480 / 550)



H.C.B-A1871-60

NEW

BENZ TRUCK FRAME RAIL NUT SOCKET (Dr. 3/4", E30, 60 mm)

BENZ 卡車車道螺帽套筒 (Dr. 3/4", E30, 60 mm)

- Special E-TORX socket for lightweight E30 nuts which can be found in the chassis area of Benz truck.
- Drive: Dr. 3/4", Head Ø 40 mm, Total length: 60 mm, E-TORX E30.
- Application: BENZ EURO 6 Truck/Mercedes Bus (405), Unimog(437), Econic (956), Actros (963), Arocs(964), Atego(967), Zetros(949).
- 特殊的 E-TORX 套筒用於賓士卡車底盤上的 E30 螺母
- 尺寸 : Dr. 3/4", Head Ø 40 mm, 總長 : 60 mm, E-TORX E30.
- 適用車種 : BENZ 六期卡車 / 賓士 巴士 (405), Unimog(437), Econic (956), Actros (963), Arocs(964), Atego(967), Zetros(949).



H.C.B-A1871-90

NEW

BENZ TRUCK FRAME RAIL NUT SOCKET (Dr. 3/4", E30, 90 mm)

BENZ 卡車車道螺帽套筒 (Dr. 3/4", E30, 90 mm)

- Special E-TORX socket for lightweight E30 nuts which can be found in the chassis area of Benz truck.
- Drive: Dr. 3/4", Head Ø 40 mm, Total length: 90 mm, E-TORX E30.
- Application: BENZ EURO 6 Truck.
- 特殊的 E-TORX 套筒用於賓士卡車底盤上的 E30 螺母
- 尺寸 : Dr. 3/4", Head Ø 40 mm, 總長 : 90 mm, E-TORX E30.
- 適用車種 : BENZ 六期卡車 .



H.C.B-A1661

BENZ TRUCK 2636 REAR WHEEL AXLE NUT SOCKET (Dr. 3/4")

BENZ 卡車 2636 後輪雙軸螺母套筒 (Dr. 3/4")

- To remove the rear wheel axle nuts.
- Application: BENZ truck 2636, 2640, 414
- Year: 2006-2016
- 此工具用來移除後輪帶動軸螺母
- 適用車種 : BENZ 卡車 2636, 2640, 414
- 年份 : 2006-2016



H.C.B-A1709

BENZ (2640/ 2644/ 2648) TRUCK TRAILER HEAD LIFTING AXLE NUT SOCKET (Dr. 3/4", 100 mm, 6 TEETH)

BENZ (2640/ 2644/ 2648) 拖車頭舉升輪軸螺帽套筒 (Dr. 3/4", 100 mm, 6 齒)

- Instruction: Socket for lift axle nut.
- Grooved lock nut.
- Application: BENZ trailer axle TZ5/2, TE5/2 with conventional bearing
- 說明 : 此工具用來拆裝舉升軸軸承螺帽
- 適用車種 : BENZ (2640/ 2644/ 2648) 拖車頭

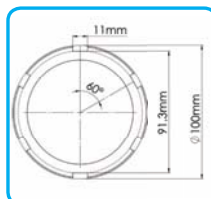

螺帽料號 :
A 976 356 00

H.C.B-A1736

BENZ DIFFERENTIAL NUT SOCKET (72 mm)

BENZ 差速器螺帽套筒 (72 mm)

- For removal and installation of differential nuts.
- With hexagon drive SW 32.
- High accuracy of fit.
- Robust execution.
- Suitable for high tightening and loosening torque.
- Application range: Mercedes Benz Citaro, Evo Bus (ZF axle 132)
- Dimension:
Inner: 72mm
Outer: 84mm
High: 60.5mm
Stud length: 12mm
Stud Width: 6mm

- 此套筒用來拆裝差速器螺母
- 六角 Drive: SW 32
- 套筒可完美貼合螺帽
- 可以高扭力進行鬆緊螺帽
- 適用範圍: Mercedes Benz Citaro, Evo Bus (ZF axle 132)

- 尺寸:
內徑: 72mm
外徑: 84mm
高度: 60.5mm
套筒腳長度: 12mm
套筒腳厚度: 6mm

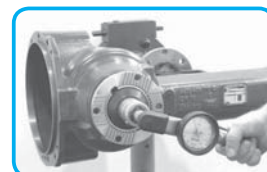

H.C.B-A1581

VOLVO (FM) CRANKSHAFT REAR OIL SEAL INSTALLER

VOLVO (FM) 曲軸後油封安裝器

- To prevent the crankshaft rear oil seal from damage when installing it. It is very easy to damage oil seal without using this tool.
- Application: VOLVO truck FM Year 00-07
- 正確使用此工具可避免安裝時損壞油封。如果未使用此工具，在更換時容易損壞到油封。
- 適用車種: VOLVO 卡車 FM 年份 00-07
- 油封料號: 85108352



Oil Seal Genuine
no.: 85108352

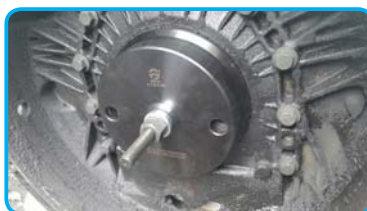

H.C.B-A1582

VOLVO (FM12) TRANSMISSION OIL TUBE NUT WRENCH (74 mm)

VOLVO (FM12) 變速箱油管螺帽扳手 (74 mm)

- Application: VOLVO FM12
- Size: Dr. 1/2", 6 Points, 74 mm
- 適用車種: VOLVO FM12
- 尺寸: Dr. 1/2" · 6 角 · 74 mm



H.C.B-A1610

VOLVO (FM) CRANKSHAFT FRONT OIL SEAL INSTALLER

VOLVO(FM) 曲軸前油封安裝工具

- If you don't use special tool to install oil seal. It might causing oil seal bad installation and leak oil. Then you will need to extract and install the part again. This tool can make installing quickly and easily.
- Instruction: Put the tool on the crankshaft, hit the handle until finish installing.
- VOLVO OEM no. ref.: 88800021, 9992000
- 若無使用特殊工具安裝油封，容易造成油封安裝不均，導致漏油，並再次重新拆卸零件，重新安裝。使用此工具可快速又準確的安裝好油封。
- 將油封放上曲軸後裝上 A1610，敲擊把柄部分，即可完成油封安裝動作
- 原廠料號：88800021, 9992000

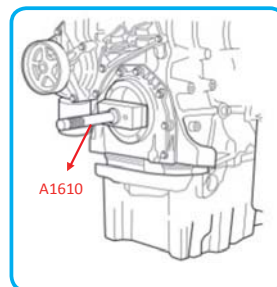

H.C.B-A1177

TOYOTA ZACE/ DAF BALL JOINT EXTRACTOR (32 mm)

TOYOTA 瑞獅 / DAF 方向機主機球頭拆卸器 (32 mm)

- Pay attention to propeller shaft removal and installation. No impact, crack, and damage are allowed. No crack or damage on propeller shaft cover is permitted.
- This is powerful while break-up the ball-joint from the tie-rod end. The nut and bolt must have at least 4 to 5 teeth installed, otherwise bolt and nut might get tighten the bolt with a wrench.
- Application: TOYOTA ZACE and DAF commercial wagon, for removal of the track rod end from the drag link.
- 拆裝傳動軸時務必注意及小心，不可使用氣動扳手、或是敲擊，避免工具損壞。
- 因為從橫拉桿接頭拆除球接頭的力道強大，所以螺母螺絲至少要 4~5 齒安裝。另外要用扳手把螺絲螺母拴緊。
- 適用車種：TOYOTA ZACE 和 DAF 商用貨車，用於拆除牽桿上的橫拉桿接頭。



DAF

H.C.B-A1675

VOLVO TRUCK CAMSHAFT LIFTING TOOL

VOLVO 卡車凸輪軸吊起工具

- Instructions: While servicing a damaged engine, use this lifting tool with a lifting device to hang the camshaft up to avoid collision. Make marks before removing the camshaft for quick and precise installation.
- OEM no. ref. : 9998264
- Application: All VOLVO (Ex: D12, D13 engine)
- ※Load capacity: 40KG. For lifting the camshaft only.
NOT suitable for other purposes.
- 說明：當引擎損壞需要維修時，使用此工具配合升降機，吊起凸輪軸，可避免人為碰撞到其他零件。拆解凸輪軸前可先做上記號，以便安裝時快速又準確。
- 原廠料號：9998264
- 適用車種：VOLVO 全車系 (例如：D12, D13 引擎)
- ※此工具負重：40KG 只適用吊起凸輪軸，請勿做其他用途使用。

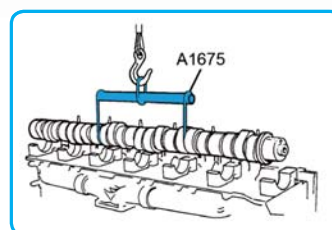

H.C.B-A1600

KENWORTH LEAF SPRING PIN & BUSHING PULLER/INSTALLATION TOOL KIT US 9505112B1 PAT. M508410

KENWORTH 彈簧插銷 & 鐵套拆裝工具組

- You can remove/ install the MR862, MR894 and MR902 bushes easily.

※Please note, MR862 and MR894 bush, they share with the same cover ring when you remove and install.

- 此工具可輕鬆拆卸 KENWORTH 的 3 種鐵套：MR862、MR894 與 MR902

※ 請注意，MR862 與 MR894 鐵套共用一個固定環。



VIDEO



H.C.B-B1773

NEW

TRAILER BUCKET STAND

板車車斗固定架

- The trailer bucket must be raised up while repairing the chassis or wiring. Use H.C.B-B1773 to hold the bucket can avoid the risk of falling bucket due to the abrupt hydraulic system failure, and provide mechanics a safer working environment.

- Base length: 800 mm, Steel thickness: 12 mm

- 說明：在維修底盤或線路時，需要將車斗抬起，進行維修。使用 H.C.B-B1773 固定車斗，可避免液壓系統故障、車斗下墜的風險，給予維修人員安全的工作環境。

- 尺寸：底座長：800mm，鋼板厚度：12mm。

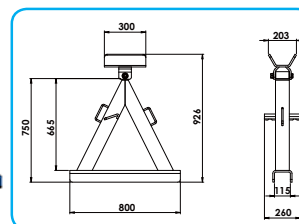

H.C.B-A1773

NEW

BPW TRAILER BUCKET STAND

BPW 板車車斗固定架

- The trailer bucket must be raised up while repairing the chassis or wiring. Use H.C.B-A1773 to hold the bucket can avoid the risk of falling bucket due to the abrupt hydraulic system failure, and provide mechanics a safer working environment.

- Base length: 800 mm, Steel thickness: 12 mm, Capacity: 5-7 TONS

- 說明：在維修底盤或線路時，需要將車斗抬起，進行維修。使用 H.C.B-A1773 固定車斗，可避免液壓系統故障、車斗下墜的風險，給予維修人員安全的工作環境。

- 尺寸：底座長：700mm，鋼板厚度：12mm，可承受約 5-7 噸

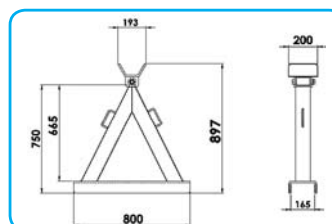

H.C.B-A1669

UNIVERSAL TRUCK REAR WHEEL HUB PULLER

萬用卡車後輪軸拔卸器

- When the axle bearing of truck is stuck due to overheating, use this tool with an air impact wrench to remove the axle easily.
- Application: Scania, DAF (CF), Volvo (FM), Japaneses truck
- 當卡車輪軸軸承過熱咬死，使用此工具搭配氣動扳手，可輕鬆將輪軸拆卸。
- 適用車種：Scania, DAF (CF), Volvo (FM), 日系卡車



H.C.B-A1789

NEW

BENZ TRUCK (DD13/ DD15) DIESEL ENGINE FRONT CRANKSHAFT OIL SEAL REMOVER / INSTALLER

BENZ 卡車 (DD13/ DD15) 柴油引擎前曲軸油封拆裝工具

- To prevent the crankshaft front oil seal from damaged when installing it.
- Application engine: DD 13 and DD15
- OEM No.: W 541 589 02 33 00
- 若無使用特殊工具安裝油封，容易造成油封安裝不均，導致漏油。使用此工具可快速又準確的安裝好油封。
- 適用引擎：DD 13 和 DD15
- OEM 號碼：W 541 589 02 33 00

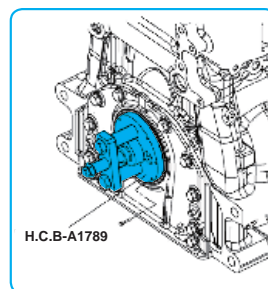

H.C.B-A1789

H.C.B-A1788

NEW

BENZ TRUCK (OM401/ OM403/ OM421 ~ OM423/ OM441 ~ OM444/ OM447/ OM457/ OM458/ OM541/ OM542/ OM941/ OM942) DIESEL ENGINE FRONT CRANKSHAFT OIL SEAL REMOVER

BENZ 卡車 (OM401/ OM403/ OM421 ~ OM423/ OM441 ~ OM444/ OM447/ OM457/ OM458/ OM541/ OM542/ OM941/ OM942) 柴油引擎前曲軸油封拆卸工具

- While replacing the oil seal, the oil seal must be removed first. The related parts might be damaged without using H.C.B-A1788.
- Application: OM401, OM403, OM421, OM422, OM423, OM441, OM442, OM443, OM444, OM447, OM457, OM458, OM541, OM542, OM941, OM942,
- OEM no.: 442 589 00 33 00
- 在更換油封時，需先將老舊的油封拆卸下來，若無使用特殊工具，在拆卸過程中，極有可能傷害到周邊的零件。H.C.B-A1788 在拆卸過程中，可避免傷害到零件的風險，快速且確保零件安全不損壞。
- 適用車種：OM401, OM403, OM421, OM422, OM423, OM441, OM442, OM443, OM444, OM447, OM457, OM458, OM541, OM542, OM941, OM942,
- OEM 號碼：442 589 00 33 00



H.C.B-A1569

SCANIA LIFT AXLE LUG PIN REMOVAL TOOL KIT (W/HYDRAULIC CYLINDER)

SCANIA 舉升軸吊耳插銷拆卸工具組 (油壓)

- This tool is designed to remove SCANIA lift axle lug pin.
- The purpose is to change the bearing.
- The tool is hydraulic content, it can use with H.C.B-B1129-Hydraulic hand pump or H.C.B-A3036-Air pump.
- It will make removal of bearing convenient and save your time.

- 此工具用來拆卸 SCANIA 舉升軸吊耳、插銷。
- 目的為更換培林，此工具為油壓設計，可搭配 H.C.B-B1129 手動幫浦 (3/8" 接頭) 或 H.C.B-A3036 (1600 c.c.) 氣動幫浦 (3/8" 接頭) 一起使用，讓拆卸變得更快速、省力。



No.	品名	尺寸	Parts No.	Description	Dimension
1	油壓缸導管	D: Ø67x145L,d:Ø48,M57x14W	1	Hydraulic cylinder guide	D: Ø67x145L,d:Ø48,M57x14W
2	連接螺絲	H17x55L, M16xP2.0,M16xP1.5	2	Connect screw	H17x55L, M16xP2.0,M16xP1.5
3	拆卸螺帽	D:Ø45x40L,d:M35xP1.5,H22	3	Removing nut	D:Ø45x40L,d:M35xP1.5,H22
4	拆卸座	D:Ø88x85L, d:Ø48	4	Removing plate	D:Ø88x85L, d:Ø48
5	油壓缸本體	8 Tons, D: M57x14W	5	Hydraulic cylinder	8 Tons, D: M57x14W

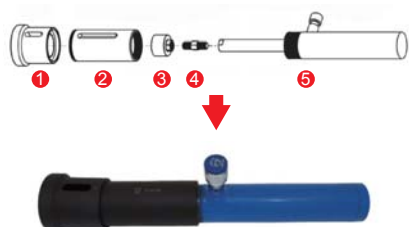

Step 1.
Take no.2 screw into No.5 hydraulic cylinder.
Connect No.3, than screw No.1 guide. Finally,
connect No.4.
步驟 1.
將 2 號連接螺絲鎖入 5 號油壓缸前端，接上 3 號拆卸螺帽，再轉入 1 號油壓缸導管，接上 4 號拆卸座

Step 2.
Because the place is narrow,
you need to screw the tool in to
plug pin first, then connect the
hand pump or air pump.
步驟 2
由於空間狹小，先將此工具套入
吊耳插銷，再裝上 H.C.B-B1129
手動或 H.C.B-A3036 氣動幫浦

Step 3.
Use the pump to remove
the plug pin from the lift
axle.
步驟 3
做動幫浦拆卸吊耳插銷

Step 4.
Finish the removing plug
pin!
步驟 4.
吊耳插銷拆卸完成！

Optional Tools 選購配件：



H.C.B-B1129
Hydraulic hand pump
(Optional)
手動幫浦 (選購配件)



H.C.B-A3036
Air pump (1600 c.c.)
(Optional)
氣動幫浦 (選購配件)

OPTIONAL:H.C.B-A3036

H.C.B-A1931

NEW

BENZ TRUCK ACTROS/ATEGO OIL SEAL INSTALLER

BENZ ACTROS/ATEGO 卡車油封安裝器

- Designed for rear axle oil seals installation.
- Ring size with thickness: 7.5/17.5/20/36mm, suitable for double seals of 746.21, 748.59....
- Applicable: BENZ ACTROS/ATEGO.
- BENZ TRUCK OEM no.ref.: 748589041500, 748589006300

- 特殊設計可快速安裝後輪軸油封
- 環的尺寸與厚度：7.5/ 17.5/ 20/ 36mm，適用在雙油封如 746.21, 748.59....
- 適用車種：BENZ ACTROS/ATEGO.
- 原廠號碼：748589041500, 748589006300



H.C.B-A1794

NEW

RENAULT TRUCK HUB SOCKET (Dr. 1", 6 POINTS, 77 mm)

RENAULT 卡車輪殼套筒 (Dr. 1", 6 角, 77 mm)

- Socket for HUB of Renault trucks.
- Size: Dr. 1", 6 POINTS, 77 mm
- Application: Renault

- 此套筒用於雷諾卡車輪殼
- 尺寸：Dr. 1", 6 角, 77 mm
- 適用車種：Renault 卡車

Dr. 1"



H.C.B-A1797

NEW

IVECO DUAL GEAR ENGINE FLYWHEEL ROTATOR (WITH 2 GEARS)

IVECO 卡車引擎飛輪轉動器 (2 齒)

- Designed for dual gear engine flywheel rotation for timing .
- Application: Euro Cargo / Cargo Eurotech / Heavyon / Off Road / Bus models.
- Engine models: 8040-25-45 / 8060-25-45 / 8460 / 8260 / 8280 / 8210.42 / 190.38 / 190.42

- 此工具設計用於轉動引擎飛輪以利正時。
- 適用車種：Euro Cargo / Cargo Eurotech / Heavyon / Off Road / Bus models.
- 引擎代號：8040-25-45 / 8060-25-45 / 8460 / 8260 / 8280 / 8210.42 / 190.38 / 190.42

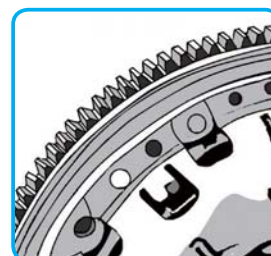

H.C.B-A1836

NEW

DAF 12-SPEED TRANSMISSION DISASSEMBLE BASE

DAF 12 速變速箱分解底座

- Use H.C.B-A1836 to disassemble the transmission will save time and labor.
- Application: DAF 12-speed transmission
- 使用此工具可輕鬆快速分解變速箱底座
- 適用車種：DAF 12 速變速箱



H.C.B-A1845

NEW

FORD TRANSIT REAR HUB NUT SOCKET

FORD TRANSIT 後載螺帽套筒

- Heavy-duty 4-point specialized impact socket for removing the rear hub nut on RWD Ford Transit.
- Alignment shaft allows accurate location onto castellated nut.
- Application: Ford Transit 2014>
- OEM no. ref.: 205-1007
- 4 點經特殊加強設計的可用來拆卸 Ford Transit RWD 後輪載。
- 適用車種：Ford Transit 2014>
- 原廠號碼：205-1007



H.C.B-A1924

NEW

DAF TRUCK FLYWHEEL ROTATOR (EURO 5&6)

DAF 卡車曲軸飛輪轉動器 (EURO 5&6)

- Application:
DAF lorries equipped with a 6-cylinder (EURO 5&6) engine.
DAF XF 105 (EURO 5)
Engine code: MX300/MX 340/MX375
- 適用車種：
DAF lorries 搭載 6- 氣缸引擎 (EURO 5&6).
DAF XF 105 (EURO 5)
引擎代號：MX300/MX 340/MX375



H.C.B-A1947

NEW

IVECO/ IRIS BUS SPECIAL SOCKET (Dr.1", 12 POINTS ,105 mm)

IVECO/ IRIS 巴士 特殊套筒 (Dr. 1", 12 角 ,105 mm)

- Size: Dr. 1", 12 POINTS ,105 mm
- Application: IVECO/ IRIS bus
- 尺寸：Dr.1", 12 角 ,105 mm
- 適用車種：IVECO/ IRIS 巴士



H.C.B-A1948

NEW

HGV BRAKE CALIPER SLOGGING WRENCH KIT (E18/ E20/ E24/ M24/ M26, Dr. 3/4")

HGV 煞車卡鉗衝擊扳手 (E18/ E20/ E24/ M24/ M26, Dr. 3/4")

- Size: E18/E20/E24/M24/M26 Dr. 3/4"
- Designed for assembly and removal of the brake caliper screw connections on commercial vehicles
- Dr. 3/4" x Torx® E18, E20, E24, and Spline M24, M26
- Torx® Applications: E18 - Man TGL/TGM, E20 - Man TGL/TGM, E24 - Man TGA/TGS/TGX
- Spline (12pt) Applications: M24 -SAF, M26 - DAF XF/XF95/ XF105/XF106

- 尺寸 : E18/ E20/ E24/ M24/ M26, Dr. 3/4"
- 設計於拆裝商用車輛上的卡鉗螺絲
- Dr. 3/4" Torx®E18 · E20 · E24 和 Spline M24 · M26
- Torx® 適用 : E18- Man TGL / TGM · E20- Man TGL / TGM · E24- Man TGA / TGS / TGX
- Spline(12 角) 適用 : M24 -SAF · M26-DAF XF / XF95 / XF105 / XF106



H.C.B-A1923

NEW

VOLVO (FM12) SERPENTINE BELT ADJUST TOOL

VOLVO (FM12) 惰輪皮帶調整扳手

- It was designed for use on remove and install fan belt when release serpentine.
- Application: VOLVO (FM12) 380/420/430.
- 此工具特別設計拆卸及安裝風扇皮帶
- 適用車種 : VOLVO (FM12) 380/ 420/ 430.





SINCE 1990

HWANG CHERNG BIN
Specialty Tools Inc.



IVECO 卡車修護工具

IVECO TRUCK REPAIR TOOL



H.C.B-IV1001

IVECO/ FUSO CRANKSHAFT FRONT OIL SEAL REMOVAL TOOL

IVECO/ FUSO 前曲軸油封拆卸工具

- Tool to remove crankshaft front oil seal.
- Application: IVECO F1C ENGINE / FUSO LIFT CARS (EURO 5)
- Models: DAILY
- For oil seal installer please refer to H.C.B-A1676
- IVECO OEM no.ref.: 99340059
- FUSO OEM no.ref.: MH063989

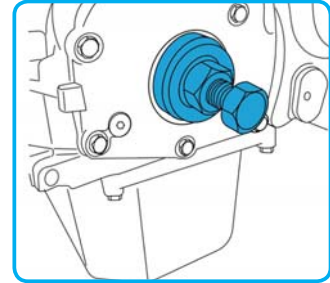

- 此工具用來拆卸前曲軸油封，使用此工具可避免在拆卸過程損害到相關零件。
- 適用車種：IVECO F1C ENGINE / FUSO LIFT CARS (EURO 5)
- 型號：DAILY
- 安裝油封請使用 H.C.B-A1676
- IVECO 原廠號碼：99340059 ■ FUSO 原廠號碼：MH063989

H.C.B-A1676

IVECO/ FUSO (3.5 TONS)TRUCK CRANKSHAFT FRONT OIL SEAL INSTALLATION TOOL

IVECO/ FUSO (3.5 噸) 卡車曲軸前油封安裝工具

- Instructions:
Installing oil seal without this tool will cause uneven installation easily which may cause oil leak, and reinstallation of oil seal will be required.
- Application: Fuso 3.5 tons (1996-2016)
- Oil genuine No: BH5679E
- Engine code: 4M40



Front oil seal genuine
No.: BH5679E
前油封原廠料號 BH5679E

- 說明：
若無使用特殊工具安裝油封，容易造成油封安裝不均，導致漏油，並需重新安裝。
使用此工具可快速又準確的安裝油封。
- 適用車種：Fuso 3.5 噸 (1996-2016 年)
- 油封料號：BH5679E ■ 引擎代號：4M40

H.C.B-IV1002

IVECO/ FUSO CRANKSHAFT REAR OIL SEAL REMOVAL TOOL

IVECO/ FUSO 後曲軸油封拆卸工具

- Tool to remove crankshaft rear oil seal.
- Application: IVECO F1C ENGINE / FUSO LIFT CARS (EURO 5)
- Models: DAILY
- For oil seal installer please refer to H.C.B-B676.
- IVECO OEM no.ref.: 99340060
- FUSO OEM no.ref.: MH063961

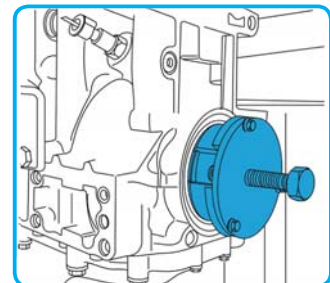

- 此工具用來拆卸後曲軸油封，使用此工具可避免在拆卸過程損害到相關零件。
- 適用車種：IVECO F1C 引擎 / FUSO LIFT CARS (EURO 5)
- 型號：DAILY
- 安裝油封請使用 H.C.B-B676
- IVECO 原廠號碼：99340060
- FUSO 原廠號碼：MH063961

H.C.B-B1676

IVECO/ FUSO(3.5 TONS) TRUCK CRANKSHAFT REAR OIL SEAL INSTALLATION TOOL

IVECO/ FUSO(3.5 噸) 卡車曲軸後油封安裝工具

■ Instructions:

Use this tool can make installation fast and precise.

- Application: FUSO 3.5 tons (1996-2016)
- Oil genuine No.: BH6237E
- Engine code: 4M40

■ 說明:

若無使用特殊工具安裝油封，容易造成油封安裝不均，導致漏油，並需重新安裝。使用此工具可快速又準確的安裝油封。

- 適用車種: FUSO 3.5 噸 (1996-2016 年)
- 油封料號: BH6237E
- 引擎代號: 4M40



Rear oil seal genuine
No.: BH6237E

H.C.B-IV1003

IVECO/ FUSO INJECTOR REMOVER

IVECO/ FUSO 噴油嘴拆卸工具

- This tool is designed for removing the injector.
- Application: IVECO DAILY F1C ENGINE (EURO 5) / FUSO LIFT CARS (EURO 5)
- Models: DAILY M.Y.2009
- IVECO OEM no.ref.: 99342156
- FUSO OEM no.ref.: MH064377

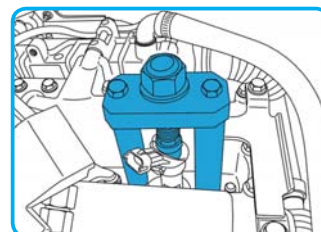

- 此工具是用來拆卸噴油嘴
- 適用車種: IVECO DAILY F1C ENGINE (EURO 5) / FUSO LIFT CARS (EURO 5)
- 型號: DAILY M.Y.2009
- IVECO 原廠號碼: 99342156
- FUSO 原廠號碼: MH064377

H.C.B-IV1004

IVECO EXTRACTOR REACTION BLOCK

IVECO 變速箱拉拔器頭

- The transmission reaction block puller.
- Application: IVECO ENGINE
- IVECO OEM no.ref.: 99345054

- 此工具為變速箱拉拔器
- 適用車種: IVECO 引擎
- IVECO 原廠號碼: 99345054



H.C.B-IV1006**IVECO/ FUSO TIMING GEAR COVER CENTERING RING**

IVECO/ FUSO 正時外蓋定位工具

- Centring ring for timing gear cover.
- Application: IVECO F1C ENGINE / FUSO LIFT CARS(EURO 5)
- Models: DAILY
- IVECO OEM no.ref.: 99396039
- FUSO OEM no.ref.: MH063979

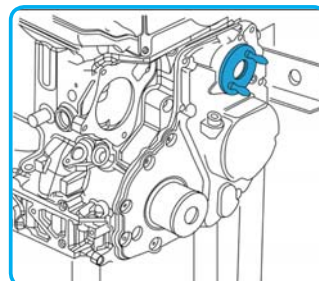

- 此工具為正時外蓋定位工具
- 適用車種：IVECO F1C 引擎 / FUSO LIFT CARS(EURO 5)
- 型號：DAILY
- IVECO 原廠號碼：99396039
- FUSO 原廠號碼：MH063979

H.C.B-IV1008**IVECO LOWER SWINGING ARM BALL JOINT REMOVER**

IVECO 大王銷拆卸工具

- Tool for removing lower swinging arm ball joint.
- Models: DAILY - TurboDaily
- IVECO OEM no.ref.: 99347060

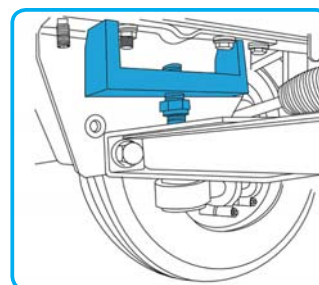

- 此工具可用來分離球接頭
- 型號：DAILY - TurboDaily
- IVECO 原廠號碼：99347060

H.C.B-IV1009**IVECO STERRING TIE ROD END/ SUSPENSION ARM BALL JOINT SEPARATOR(25.5 mm)**

IVECO 橫直拉桿球頭拉拔器 (25.5mm)

- Tool for separating suspension arm ball joint.
- Application: AXLE 5817 ,IVECO ENGINE
- IVECO OEM no.ref.: 99347074

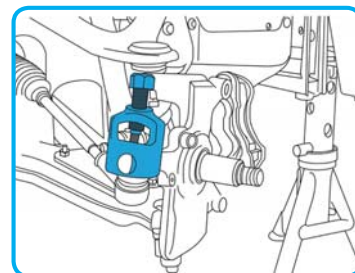

- 此工具可用來分離橫直拉桿球接頭
- 適用車種：AXLE 5817 ,IVECO 引擎
- IVECO 原廠號碼：99347074

H.C.B-IV1010

IVECO/ FUSO INJECTOR PIPES WRENCH (17 mm)

IVECO/ FUSO 噴油嘴油管套筒 (17 mm)

- Wrench (17 mm) for tightening injector pipes to torque.
- Application: IVECO F1C ENGINE / FUSO LIFT CARS (EURO 5)
- Models: Daily M.Y. 2009
- IVECO OEM no. ref.: 99352115
- 特殊 17mm 套筒設計，可快速方便的鬆緊螺母
- 適用車種：IVECO F1C 引擎 / FUSO LIFT CARS (EURO 5)
- 型號：Daily M.Y. 2009
- IVECO 原廠號碼：99352115

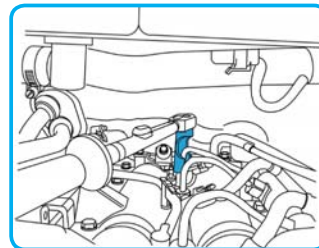

H.C.B-IV1011

IVECO KING PIN LOCK RING WRENCH

IVECO 大王銷固定環套筒

- Socket for king pin lock ring.
- Application: Daily 2006 (E4)
- IVECO OEM no. ref.: 99357151
- 此套筒可用來拆卸或安裝大王銷環
- 適用車種：Daily 2006 (E4)
- IVECO 原廠號碼：99357151

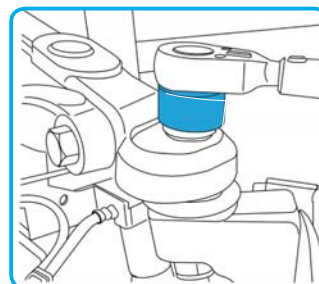
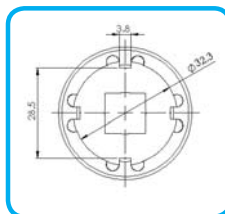
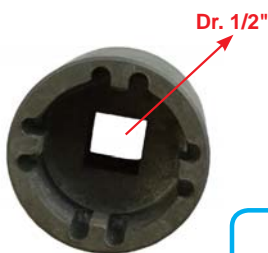

H.C.B-IV1012

IVECO/ FUSO DRIVE SHAFT VALVE RETAINING TOOL

IVECO/ FUSO 轉向閥固定支架

- Oil pump drive shaft retaining tool.
- Application: IVECO F1C-F1D ENGINE/ FUSO LIFT CARS (EURO 5)
- Models: DAILY
- IVECO OEM no. ref.: 99360187
- FUSO OEM no. ref.: MH063965
- 此工具可用來固定轉向泵，以利進行其他維修工作
- 適用車種：IVECO F1C-F1D 引擎 / FUSO LIFT CARS (EURO 5)
- 型號：DAILY
- IVECO 原廠號碼：99360187
- FUSO 原廠號碼：MH063965

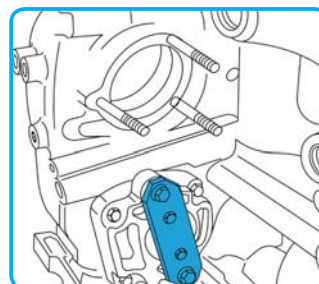

H.C.B-IV1013**IVECO/ FUSO ENGINE VALVE REMOVER/ INSTALLER**

IVECO/ FUSO 引擎汽門拆裝工具

- Engine valves spring remover/ installer.
- Application: IVECO F1A-F1C ENGINE/ FUSO LIFT CARS(EURO 5)
- Models: DAILY-DUCATO
- IVECO OEM no. ref.: 99360260
- FUSO OEM no. ref.: MH063966

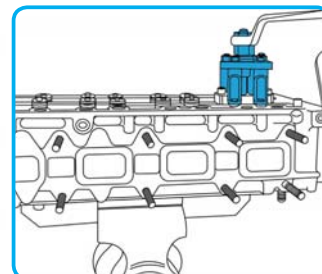

- 此工具可輕鬆、快速的拆卸及安裝引擎汽門
- 適用車種：IVECO F1A-F1C 引擎 / FUSO LIFT CARS(EURO 5)
- 型號：DAILY-DUCATO
- IVECO 原廠號碼：99360260
- FUSO 原廠號碼：MH063966

H.C.B-IV1014**IVECO/ FUSO FLYWHEEL COUNTER HOLDING TOOL**

IVECO/ FUSO 飛輪支擋工具

- For counter holding the flywheel.
- Application: IVECO F1A-F1C ENGINE/ FUSO LIFT CARS (EURO 5)
- Models: DAILY
- IVECO OEM no. ref.: 99360306
- FUSO OEM no. ref.: MH063967

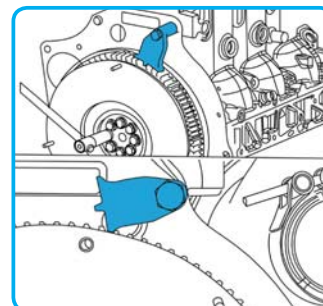

- 此工具可用來固定飛輪
- 適用車種：IVECO F1A-F1C 引擎 / FUSO LIFT CARS (EURO 5)
- 型號：DAILY
- IVECO 原廠號碼：99360306
- FUSO 原廠號碼：MH063967

H.C.B-IV1015**IVECO/ FUSO CAMSHAFT TIMING TOOL**

IVECO/ FUSO 凸輪軸正時工具

- Tool for camshaft timing.
- Application: IVECO F1A ENGINE/ FUSO LIFT CARS (EURO 5)
- Models: DAILY - DUCATO
- IVECO OEM no. ref.: 99360614
- FUSO OEM no. ref.: MH063968

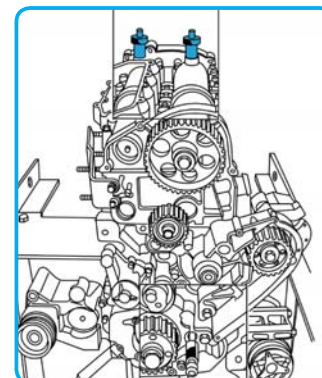

- 此工具用於調整凸輪軸正時
- 適用車種：IVECO F1A 引擎 / FUSO LIFT CARS (EURO 5)
- 型號：DAILY - DUCATO
- IVECO 原廠號碼：99360614
- FUSO 原廠號碼：MH063968

H.C.B-IV1016

IVECO/ FUSO CRANKSHAFT TIMING TOOL

IVECO/FUSO 曲軸正時工具

- Tool for crankshaft timing.
- Application: IVECO F1A ENGINE/ FUSO LIFT CARS (EURO 5)
- Models: DAILY - DUCATO
- IVECO OEM no. ref.: 99360615
- FUSO OEM no. ref.: MH063969

- 此為曲軸正時工具
- 適用車種：IVECO F1A 引擎 / FUSO LIFT CARS(EURO 5)
- 型號：DAILY - DUCATO
- IVECO 原廠號碼：99360615
- FUSO 原廠號碼：MH063969

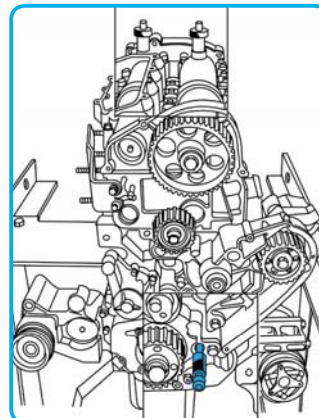

H.C.B-IV1017

IVECO GEARBOX OUTPUT SHAFT BEARING/ FLANGE INSTALLER

IVECO 變速箱輸出軸培林 / 凸緣盤安裝工具

- Tool to install bearing and flange on output side of gearbox main shaft.
- Application: Gearbox ZF: S5-200, S6-300
- Models: Daily/ TurboDaily 29-35-50
- IVECO OEM no. ref.: 99370234

- 此為安裝培林與凸緣盤至變速箱主軸的輸出軸上
- 適用車種：ZF 變速箱：S5-200, S6-300
- 型號：Daily/ TurboDaily 29-35-50
- IVECO 原廠號碼：99370234

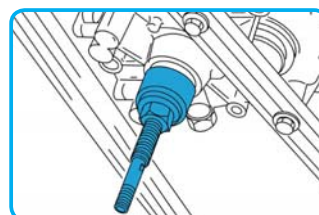

H.C.B-IV1018

IVECO DIFFERENTIAL LOCATING PIN

IVECO 差速器定位銷

- Gauge, bevel pinion shim.
- Application: Rear axle NDA
- Models: Daily Restyling 2006
- IVECO OEM no. ref.: 99370239

- 此為差速器定位工具
- 適用車種：Rear axle NDA
- 型號：Daily Restyling 2006
- IVECO 原廠號碼：99370239

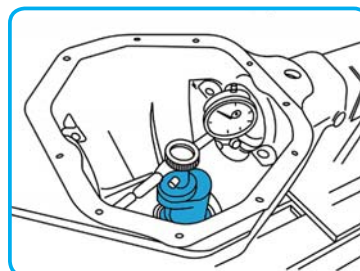

H.C.B-IV1019

IVECO TRANSMISSION OUTPUT SHAFT LOCKING TOOL

IVECO 變速箱輸出軸固定工具

- Reaction lever with extension for flanges retaining.
- Application: IVECO ENGINE
- IVECO OEM no. ref.: 99370317

- 此工具可用來固定變速箱輸出軸，以利其他維修工作
- 適用車種：IVECO 引擎
- IVECO 原廠號碼：99370317

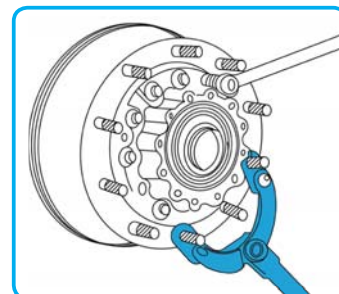

H.C.B-IV1020

IVECO WHEEL HUB BEARING INSTALLER

IVECO 輪轂培林安裝工具

- Tool for driving bearing and phonic wheel over the wheel hub.
- Application: Rear axle 4511
- Models: Daily - TurboDaily (Range 96)
- IVECO OEM no. ref.: 99370498

- 此工具用於安裝培林與感應環至輪轂上
- 適用車種：Rear axle 4511
- 適用型號：Daily - TurboDaily (Range 96)
- IVECO 原廠號碼：99370498

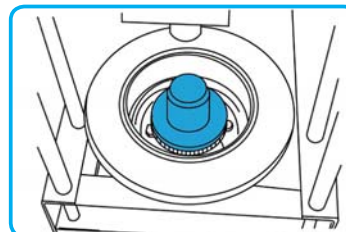
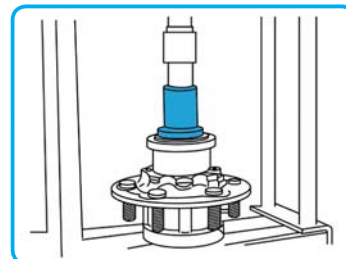

H.C.B-IV1021

IVECO TRANSMISSION REAR COVER OIL SEAL INSTALLER

IVECO 變速箱後油封安裝工具

- Installer, rear cover seal.
- Application: Gerbox ZF S6-300
- Models: TurboDaily 35 (C13-S13)- 50C (11-13)
- IVECO OEM no. ref.: 99374454

- 此工具用來安裝變速箱後油封。使用此工具安裝能平均受力，避免因施力不均，導致安裝不準確
- 適用車種：ZF 變速箱 S6-300
- 適用型號：TurboDaily 35 (C13-S13)- 50C (11-13)
- IVECO 原廠號碼：99374454

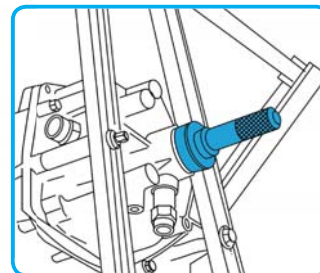

H.C.B-IV1022

IVECO TRANSMISSION FRONT COVER OIL SEAL INSATALLER

IVECO 變速箱前油封安裝工具

- For installing the oil seal of transmission front cover.
- Application: Gearbox ZF S6-300
- Models: TurboDaily 35 (C13-S13)- 50C (11-13)
- IVECO OEM no. ref.: 99374455

- 此工具可準確的安裝變速箱前油封，避免相關零件受損
- 適用車種：ZF 變速箱 S6-300
- 適用型號：TurboDaily 35 (C13-S13)- 50C (11-13)
- IVECO 原廠號碼：99374455

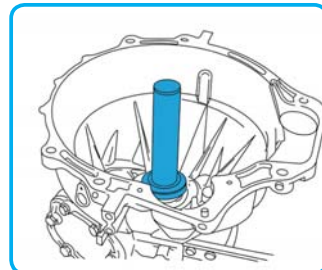

H.C.B-IV1023

IVECO DIFFERENTIAL BEVEL PINION GASKET INSTALLER

IVECO 差速器盆型齒輪安裝工具

- To install differential bevel pinion gasket.
- Application: IVECO ENGINE
- IVECO OEM no. ref.: 99374462
- 用於安裝差速器盆型齒輪油封。
- 適用車種：IVECO 引擎
- IVECO 原廠號碼：99374462



H.C.B-IV1024

IVECO/ FUSO ALTERNATOR PULLEY WRENCH

IVECO/ FUSO 發電機皮帶盤拆裝工具

- Wrench to remove and refit alternator pulley.
- Application: IVECO F1C ENGINE/ FUSO LIFT CARS (EURO 5)
- Models: DAILY
- IVECO OEM no. ref.: 99358026
- 此套筒為拆裝發電機的皮帶盤工具
- 適用車種：IVECO F1C 引擎 / FUSO LIFT CARS (EURO 5)
- 適用型號：DAILY
- IVECO 原廠號碼：99358026

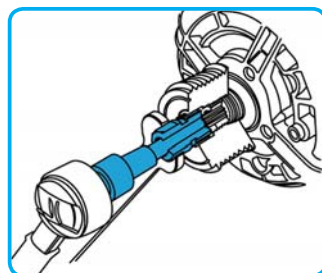

H.C.B-IV1025

IVECO/ FUSO FLEXIBLE BELT INSTALLER

IVECO/ FUSO 皮帶安裝工具

- Guide for flexible belt.
- Application: IVECO F1C ENGINE/ FUSO LIFT CARS (EURO 5)
- Models: DAILY
- IVECO OEM no. ref.: 99360186
- 此工具用於安裝普利盤皮帶。
- 適用車種：IVECO F1C ENGINE/ FUSO LIFT CARS (EURO 5)
- 適用型號：DAILY
- IVECO 原廠號碼：99360186

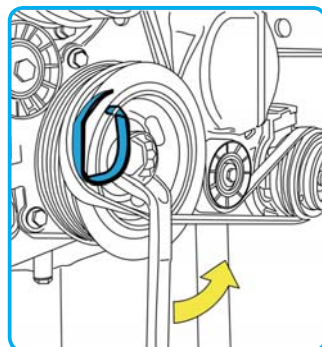

H.C.B-IV1026

IVECO TRANSMISSION MAIN SHAFT/ COUNTER SHAFT/ FORK ASSEMBLY REMOVER/ INSTALLER

IVECO 變速箱主軸 / 副軸 / 撥叉總成拆裝工具

- Tool to pull out and fit main shaft, secondary shaft and fork assembly.
- Application: Gearbox ZF S6-300
- Models: TurboDaily 35 (C13-S13) - 50C (11-13)
- IVECO OEM no. ref.: 99360522

- 此工具為變速箱主軸 / 副軸 / 撥叉總成的拆裝工具
- 適用車種 : Gearbox ZF S6-300
- 適用型號 : TurboDaily 35 (C13-S13) - 50C (11-13)
- IVECO 原廠號碼 : 99360522

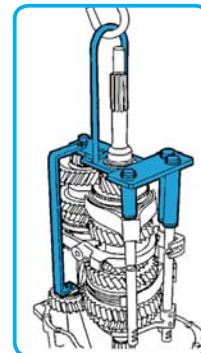

H.C.B-IV1027

IVECO TRANSMISSION (INPUT SHFAT) FRONT CASING EXTRACTOR

IVECO 變速箱 (輸入軸) 前蓋拉拔器

- Extractor for gearbox front half-casing.
- Application: Gearbox ZF S5-200- ZF S6-300
- Models: Daily/ TurboDaily 2000
- IVECO OEM no. ref.: 99345003

- 用於拆卸差速器前蓋。
- 適用車種 : Gearbox ZF S5-200- ZF S6-300
- 適用型號 : Daily/ TurboDaily 2000
- IVECO 原廠號碼 : 99345003

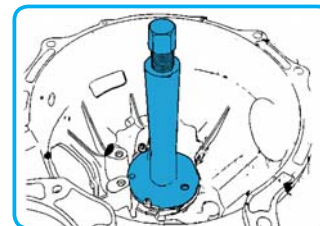

H.C.B-IV1028

IVECO WHEEL HUB NUT SOCKET (Dr. 3/4", 12 POINTS, 65 mm)

IVECO 輪轂螺帽套筒 (Dr. 3/4", 12 角 · 65 mm)

- Wrench 12-point (65 mm) for nut wheel hub.
- Application: Rear axle 4511
- Models: Daily-TurboDaily (Range 96)
- IVECO OEM no. ref.: 99355087

- 特殊 12 角, 65 mm 套筒用來拆裝輪轂
- 適用車種 : Rear axle 4511
- 適用型號 : Daily-TurboDaily (Range 96)
- IVECO 原廠號碼 : 99355087

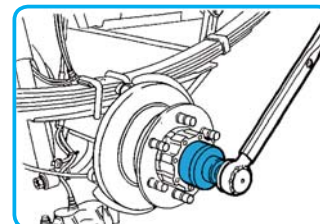

H.C.B-IV1029

IVECO WHEEL HUB BEARING NUT SOCKET (Dr. 3/4", 6 POINTS, 91.5 mm)

IVECO 輪轂培林螺帽套筒 (Dr. 3/4", 6 角 · 91.5 mm)

- Socket (91.5mm) for adjusting wheel hub bearings nut.
- Application: Rear axle- R0537 (4517)-R0753 (F125E)-R0653 (F120E)-4536HR
- Models: 59.12-80.13A/ AH-80.16A-90.13A/ AH-95.14 EuroCargo/ Cargo (60E10-60E12-60E14-65E10-65E12-65E14-75E12-75E14-75E15-100E15-100E18-100E21)
- IVECO OEM no. ref.: 99357080

- 此套筒 (91.5mm) 用於拆卸及安裝輪轂培林螺帽。
- 適用車種: Rear axle- R0537 (4517)-R0753 (F125E)-R0653 (F120E)-4536HR
- 適用型號: 59.12-80.13A/ AH-80.16A-90.13A/ AH-95.14 EuroCargo/ Cargo (60E10-60E12-60E14-65E10-65E12-65E14-75E12-75E14-75E15-100E15-100E18-100E21)
- IVECO 原廠號碼: 99357080

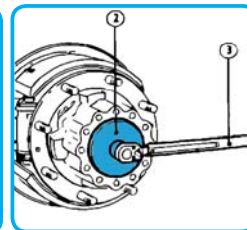
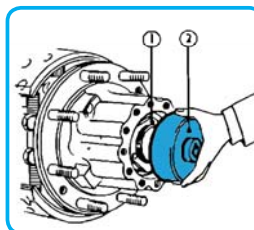

H.C.B-IV1030

IVECO ABS SENSOR MOUNT POSITIONING TOOL

IVECO ABS 感應器位置測量器

- Gauge for ABS sensor mount positioning.
- Application: Rear axle 4517/ 2 (2010)
- Models: DAILY M.Y. 2009
- IVECO OEM no. ref.: 99395030

- 此工具可測量感應器位置是否正確
- 適用車種: Rear axle 4517/ 2 (2010)
- 型號: DAILY M.Y. 2009
- IVECO 原廠號碼: 99395030

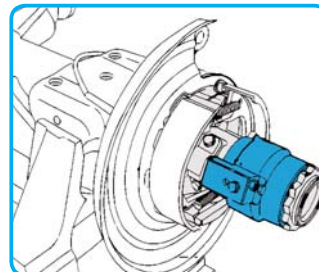

H.C.B-IV1031

IVECO FRONT SUSPENSION SPRING SLEEVE REMOVER

IVECO 前懸吊鐵套拆卸工具

- Tool for disassembling front suspension spring sleeves.
- Application: Axle 5823
- Models: Daily City Camion (65C14)
- IVECO OEM no. ref.: 99347027

- 此工具可快速將前懸吊上的鐵套拆卸下，省下許多時間及人力
- 適用車種: Axle 5823
- 型號: Daily City Camion (65C14)
- IVECO 原廠號碼: 99347027

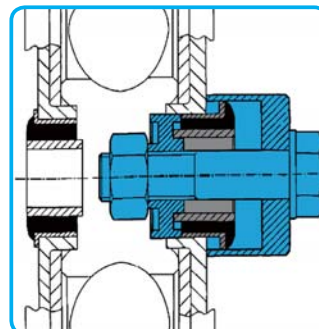

H.C.B-IV1032

IVECO FRONT SUSPENSION SPRING SLEEVE INSTALLER

IVECO 前懸吊鐵套安裝工具

- Tool for assembling front suspension spring sleeves.
- Application: Axle 5823
- Models: Daily City Camion 65C14
- IVECO OEM no. ref.: 99374166
- 此工具可快速將鐵套安裝至前懸吊，省下許多時間及人力
- 適用車種：Axle 5823
- 型號：Daily City Camion 65C14
- IVECO 原廠號碼：99374166

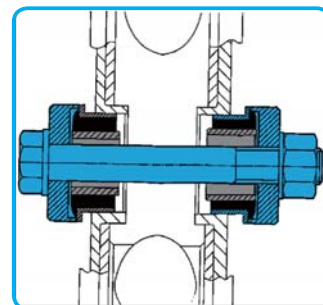

H.C.B-IV1033

PISTON RING COMPRESSOR

活塞安裝工具

- Used to guide the piston into the cylinder sleeve during piston installation.
- 當安裝活塞時，此工具用於壓縮活塞環並導入汽缸套。

Item number 編號	Range 範圍	Height 高度
IV1033-A	57-125 mm	100 mm
IV1033-B	38-83 mm	50 mm
IV1033-C	57-125 mm	80 mm
IV1033-D	90-175 mm	80 mm
IV1033-E	90-175 mm	80 mm
IV1033-F	90-175 mm	165 mm

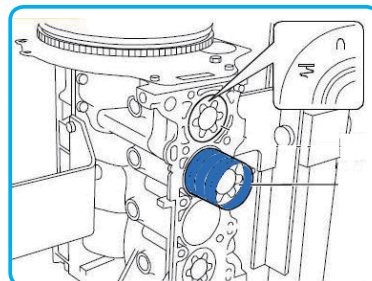

H.C.B-A1915

NEW

IVECO BRAKE CALIPER WIND BACK KIT

IVECO 煞車分泵調整組

- Note: Take great care at all times not to damage or snag the brake hose as this may subsequently make the vehicle unsafe.
- DO NOT allow the calliper to hang free by its flexible hose.
- 注意：請務必注意維修過程中不要損壞或阻塞剎車油管，如此可能會導致車輛剎車失靈，造成行車上的危險。
- 請勿使用剎車油管吊掛卡鉗，讓卡鉗懸掛在半空中。
- 注意：有些卡鉗需要在有壓力的情況下，才可推回活塞。為此，請使用擋片（圖 1）。使用前請滴幾滴潤滑油來潤滑螺桿。





SINCE 1990

HWANG CHERNG BIN
Specialty Tools Inc.



日系卡車修護工具

JAPANESE TRUCK REPAIR TOOL

H.C.B-A1127

FUSO REAR WHEEL NUT SOCKET (8 POINTS, 120 mm)

FUSO 卡車後輪螺帽拆裝套筒 (8 角, 120 mm)

2 / 17.1 / 19 / 1.26'

- Fixing bearing in the right position while removing / installing the truck nut.
- Adjusting the nut with slide rod to adjust the tightness of bearing.

- 在拆卸或安裝卡車螺帽時，用來固定培林。
- 以滑桿調整螺帽，以控制培林的鬆緊度。



H.C.B-A1184

HINO CRANKSHAFT REAR OIL SEAL INSTALLER (JO8C/ JO8E)

HINO 卡車曲軸後油封安裝器 (JO8C/ JO8E)

- This tool is designed for preventing oil seal from damage when installing it.
- Application: HINO 10.5/15/17 TONS;(JO8C/JO8E)
- Oil seal no.: AZ 4079-F, AZ 4079-G

- 本工具經過特殊設計，可在安裝過程避免損傷油封。
- 適用車種：HINO 10.5 噸 / 15 噸 / 17 噸 (JO8C/JO8E) 卡車。
- 油封料號：AZ 4079-F, AZ 4079-G

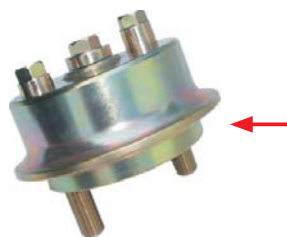

H.C.B-B1184

HINO CRANKSHAFT FRONT OIL SEAL INSTALLER

HINO 卡車曲軸前油封安裝器

- This tool is designed for preventing the HINO crankshaft front oil seal from damage when installing it.
- Application: HINO truck and 35 TONS ; PROFIA K13C-TE 350P、700 series E13C 420P
- Oil seal genuine no.:AH3618-M, BZ5376E
- Tools genuine no:09407-1190

- 本工具經過特殊設計，在安裝 HINO 曲軸前油封時，可避免損傷油封。
- 適用車種：HINO 卡車及 35 噸、大將 K13C-TE 350P、700 系列 E13C 420P。
- 油封料號：AH3618-M、BZ5376E
- 工具料號：09407-1190



H.C.B-C1184

HINO CRANKSHAFT FRONT OIL SEAL INSTALLER (JO8C/ JO8E)

HINO 卡車曲軸前油封安裝器 (JO8C/ JO8E)

- This tool is designed for preventing oil seal from damage while installing.
- Save time and labor.
- Application: HINO 10.5, 15, 17TONS,(JO8C/JO8E) EURO 3/5.
- Oil seal genuine no.: BZ4820E
- 使用方法：本工具經過特殊設計，可在安裝過程避免損傷油封，精確將油封裝入到適當的位置，省時又好用。
- 適用車種：HINO 10.5, 15, 17 噸 ,(JO8C/JO8E) EURO 3/5.
- 油封料號：BZ4820E



H.C.B-A1178

FUSO/HINO PROFIA 700 STEERING MECHANISMOIL SEAL SOCKET (Dr. 1/2")

FUSO/HINO 大將 700 卡車方向機油封套筒 (Dr. 1/2")

12 / 13.8 / 15 / 1.04'

- While replacing steering mechanism oil seal, this tool is to regulate the nut and prevent nut from damage.
- Application: Most of Japanese truck. (ex. FUSO/HINO PROFIA 700/HINO 17 TONS)
- 在更換方向機油封時，用本工具來調整螺帽，可避免螺帽損壞。
- 適用車種：大部份日系卡車的方向機。例如：FUSO/HINO 大將 700/HINO 17 噸

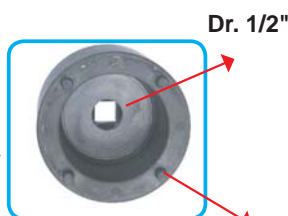

PCD 70 mm x Ø6 x 4 POINTS

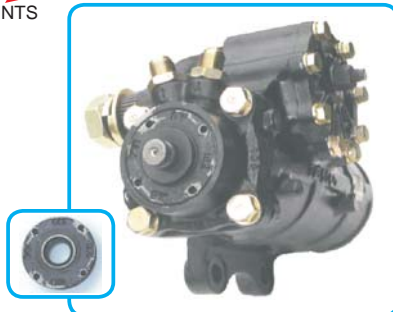

H.C.B-B1178

FUSO STEERING MECHANISM OIL SEAL SOCKET(Dr. 1/2") (UNDER 15 TONS)

FUSO 方向機油封套筒 (Dr. 1/2") (15 噸以下)

- While replacing steering mechanism oil seal, this tool is to regulate the nut and prevent nut from damage.
- Application: Most of Japanese truck. (ex. FUSO under 15 TONS/3.5 TONS (Euro 4))
- 在更換方向機油封時，用此工具來調整螺帽，可避免螺帽損壞。
- 適用車種：大部份日系卡車的方向機。例如：FUSO 15 噸以下 /3.5 噸 (4 期))



Dr. 1/2"

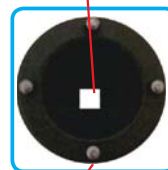

PCD 53 mm x Ø5.5 x 4 POINTS



H.C.B-C1178

FUSO CANTER (3.5 TONS) STEERING GEAR OIL SEAL SOCKET (Dr. 1/2") (EURO 4)

FUSO 堅達 (3.5 噸) 方向機主機油封螺母套筒 (Dr. 1/2") (四期環保)

- While replacing steering mechanism oil seal, this tool is to regulate the nut and prevent nut from damaged.
- Application: FUSO Canter 3.5 tons. (Euro 4)
- 在更換方向機油封時，用此套筒來調整螺帽，可避免螺帽的損壞
- 適用車種：FUSO 堅達 3.5 噸 (4 期)



H.C.B-A1683

FUSO (3.5/6.5~7.7 TONS)/ ISUZU 7.5 TONS TRUCK REAR AXLE NUT SOCKET

FUSO (3.5/6.5~7.7 噸) / ISUZU 7.5 噸卡車後輪軸螺帽套筒

- Remove the rear wheel axle nut of ISUZU or FUSO.
- It can be used with torque wrench for installing and removing. Changeable pins can be used on different kind of trucks.
- Application: FUSO (3.5/6.5~7.7 TONS)/ ISUZU 7.5 TONS truck.
- PCD: 74 mm, 80mm

- 說明：此工具用來拆卸後輪軸螺帽，前端插銷為特殊設計，可依照不同車型做更換。
- 適用車種：FUSO (3.5/6.5~7.7 噸) / ISUZU 7.5 噸卡車
- PCD: 74 mm, 80 mm



Changeable pins
可更換式插銷



H.C.B-A1691

FUSO AIR HOSE REMOVER (6 PCS)

FUSO 氣管快拆扳手組 (6 PCS)

- Instruction: This tool makes removal of hose easier and quicker.
- Size: 6, 8, 10, 12, 15, 16 mm
- Material: Stainless steel
- Application: FUSO Trailer head, tour bus, HINO truck

- 說明：使用此工具可快速拆卸氣管
- 尺寸：6, 8, 10, 12, 15, 16 mm
- 材質：不鏽鋼
- 適用車種：FUSO 拖車頭，遊覽車，HINO 卡車

※The air must be exhausted before removing the hose, otherwise the hose will be unremovable due to the air pressure.

※ 拆除氣管前，要先行把全車空氣漏光，避免因空氣壓力而無法拔除氣管。



H.C.B-A1270

HINO STEERING MECHANISM OIL SEAL SOCKET (Dr. 1/2")

HINO 方向機油封套筒 (Dr. 1/2")

- This socket is to loosen/tighten the nut when replacing steering mechanism oil seal. It could cause damage without using this tool while replacing oil seal.
- Application: For HINO truck use only. (After 1994, 21~35 tons truck.)
- 更換方向機油封之前，必須先用本工具拆下螺帽。待更換完畢後，再用本工具將螺帽裝回。若未使用工具進行拆裝，則易傷及零件。
- 適用範圍：HINO 卡車 (1994 年以後車種，21 噸 ~35 噸) 專用，方向機油封更換拆裝。

Dr. 1/2"

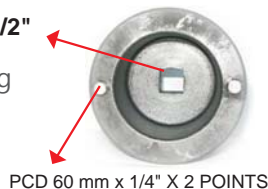

H.C.B-A1210

MITSUBISHI CANTER/ FUSO AXLE BALL JOINT PULLER

三菱堅達 / FUSO 仰角球接頭拆卸器

- Special design. Easy to use. The hooks are adjustable, suitable to different ball joints.
- For Mitsubishi Canter front wheel axle ball joint.
- Application: Mitsubishi Canter 3.5 tons, 4.4 tons and Fuso Rosa.
- 特殊設計、方便使用。可調式雙爪，適用於各種尺寸的球接頭。
- 可用於 Mitsubishi Canter 前輪軸球接頭。
- 適用車種：Mitsubishi 堅達 3.5 噸、4.4 噸和 Fuso Rosa



Illustration for use



Auto part



Genuine stock No.:
Mc819642

H.C.B-A1248

MITSUBISHI DELICA 2500 c.c. WHEEL NUT SOCKET (Dr. 1/2")

得利卡 2500 c.c. 輪軸螺帽套筒 (Dr. 1/2")

- Socket for the wheel nut.
- Application: Mitsubishi DELICA 2500 c.c.
- 可用來拔卸輪軸螺帽。
- 適用車種：Mitsubishi 得利卡 2500 c.c.



Dr. 1/2"

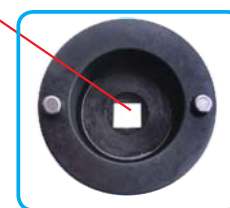

P.C.D. 60mm x Ø 8 x 2

H.C.B-A1275

HINO/ ISUZU/ FUSO/ UD ANCHOR PIN REMOVER (HYDRAULIC)

HINO/ ISUZU/ FUSO/ UD 剎車來令片插銷拔卸器 (油壓)

- Application: HINO/ ISUZU/ FUSO/ UD truck.
- 適用車種：HINO/ ISUZU/ FUSO/ UD 卡車

No.	Component Name	Descriptions	Q'ty
1	Cylinder	6 Tons	1
2	Cylinder Fixation	∅ 67 x 48 x 145L	1
3	Cylinder Prolongation	∅ 74 x 32 x 53L	1
4	M16 x P1.5 Anchor Pin Extractor	M16 x P2.0 x H17 x M16 x P1.5	1
5	M14 x P1.5 Anchor Pin Extractor	M16 x P2.0 x H17 x M14 x P1.5	1
6	M12 x P1.25 Anchor Pin Extractor	M16 x P2.0 x H17 x M12 x P1.25	1
7	M12 x P1.0 Anchor Pin Extractor	M16 x P2.0 x H17 x M12 x P1.0	1
8	M16 x P1.5 Tap	M16 x P1.5 (SKS)	1
9	M14 x P1.5 Tap	M14 x P1.5 (SKS)	1
10	M12 x P1.25 Tap	M12 x P1.25 (SKS)	1
11	M12 x P1.0 Tap	M12 x P1.0 (SKS)	1



VIDEO



H.C.B-B1129
Hydraulic Hand Pump
(Optional accessory)



1. Connect anchor pin extractor with anchor pin and cylinder fixation.
把來令片插銷、油壓缸固定座和來令片插銷拔卸器連結。



2. To remove anchor pin from brake by hydraulic hand pump.
以手動幫浦施力，將插銷由來令片中拔出。



3. Take off anchor pin.
取下來令片插銷。



4. Anchor pin and anchor pin extractor.
來令片插銷和拔卸器示意圖。

H.C.B-B1275

NEW

HINO/ ISUZU/ FUSO/ UD TRUCK ANCHOR PIN REMOVER (12 TONS HYDRAULIC)

HINO / ISUZU / FUSO / UD 卡車剎車來令片插銷拔卸器 (12 噸油壓)

- Feature: It is a hard work to remove the pin from the drum brake. You will waste lot of time removing it. With B1275, the anchor pin will be removed easily.
- Application: HINO/ ISUZU/ FUSO/ UD truck.
- 特色：要將插銷從卡車上的剎車片拔出是非常困難的工作，傳統方式將會需要花費許多人力與時間。使用 B1275，一個人即可在幾分鐘之內完成原本耗時、耗力的工作
- 適用車種：HINO/ ISUZU/ FUSO/ UD 卡車

No.	Component Name	Descriptions	Q'ty
1	Hydraulic Cylinder	12 Tons	1
2	Cylinder Fixation	∅ 67 x 48 x 150L	1
3	Cylinder Prolongation	∅ 74 x 38 x 53L	1
4	M16 x P1.5 Anchor Pin Extractor	M16 x P2.0 x H17 x M16 x P1.5	1
5	M14 x P1.5 Anchor Pin Extractor	M16 x P2.0 x H17 x M14 x P1.5	1
6	M12 x P1.25 Anchor Pin Extractor	M16 x P2.0 x H17 x M12 x P1.25	1
7	M12 x P1.0 Anchor Pin Extractor	M16 x P2.0 x H17 x M12 x P1.0	1
8	M16 x P1.5 Tap	M16 x P1.5 (SKS)	1
9	M14 x P1.5 Tap	M14 x P1.5 (SKS)	1
10	M12 x P1.25 Tap	M12 x P1.25 (SKS)	1
11	M12 x P1.0 Tap	M12 x P1.0 (SKS)	1



H.C.B-A3036
AIR PUMP(1600C.C.)
(Dr. 3/8" ADAPTOR)
(Optional accessory)
選購配件

H.C.B-A1286

HINO 11.9 TONS REAR WHEEL AXLE NUT SOCKET (Dr. 3/4", 8 POINTS, 105 mm)

HINO 11.9 噸後輪軸螺帽套筒 (Dr. 3/4", 8 角, 105 mm)

- Apply to HINO 11.9 tons truck rear wheel axle nut removal / installation.
- Size: Dr. 3/4", 8 points, 105 mm
- 拆裝 HINO 11.9 噸卡車後輪軸螺帽用。
- 尺寸：Dr. 3/4", 8 角, 105mm

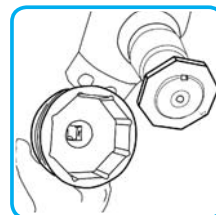
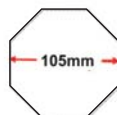
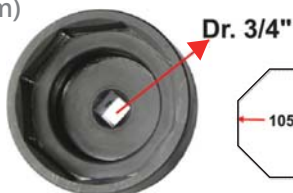

H.C.B-B1056

ISUZU 3.5 TONS/ FUSO CANTER 3.5 TONS REAR WHEEL AXLE NUT SOCKET

ISUZU 3.5 噸 / FUSO CANTER 3.5 噸後輪軸螺帽套筒

- Socket for the rear wheel axle nut of ISUZU.
- It can be used with torque wrench for installing and removing.
- Material: S45C.
- Application: ISUZU 130 HP, 150 HP CANTER Series 4/ Series 5

- 此工具用來拆卸 ISUZU 後輪軸螺帽
- 可以配合使用扭力扳手拆裝
- 材質：S45C
- 適用車種：ISUZU 130 HP, 150 HP CANTER 四期 / 五期



H.C.B-A1122

ISUZU CRANKSHAFT OIL SEAL REPLACER

ISUZU 曲軸油封更換器

1 / 18.6 / 19.4 / 0.85'

- The best tool for replacing crankshaft oil seal.
- No damage to oil seal and related parts.
- Easy to use. Help to install the oil seals accurately. Save time and money.
- Application: ISUZU truck. Engine model: 4HE1, 4HF1, 4HG1, 6HH1, 6HK1.
- Oil seal genuine no.: Front oil seal BZ4219E Rear oil seal BZ4365E
- 更換曲軸油封的最佳工具。
- 不會損傷油封及相關零件。
- 操作簡便，可正確安裝油封。
- 適用車種：ISUZU 卡車
- 引擎型號：4HE1, 4HF1, 4HG1, 6HH1, 6HK1
- 油封料號：前油封 BZ 4219 E、後油封 BZ 4365 E

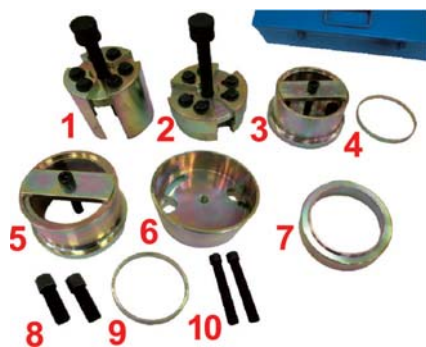

Front oil seal: BZ4219E
Size: 10x109x137



Rear oil seal: BZ4365E
Size: 10x104x139



H.C.B-A1261

ISUZU CRANKSHAFT REAR OIL SEAL INSTALLER (3.5 TONS)

ISUZU 曲軸後油封安裝器 (3.5 噸)

- This tool is specially designed for preventing the oil seal from damage when installing it.
- Oil seal genuine no.: BZ4962-E, 3-97071561
- Application: ISUZU 3.5 tons (4JB1, 4JG2) (130 HP/ 150 HP) (4JG1) (4JH1)
- 經過特殊設計，可在安裝過程避免損傷油封。
- 油封料號：BZ4962-E · 3-97071561
- 適用車種：ISUZU 3.5 噸卡車。
(4JB1, 4JG2) (130 HP/ 150 HP) (4JG1) (4JH1)



H.C.B-B1261

ISUZU CRANKSHAFT FRONT OIL SEAL INSTALLER (3.5 TONS)

ISUZU 曲軸前油封安裝器 (3.5 噸)

- This tool is specially designed for preventing the oil seal from damage when installing it.
- Oil seal genuine no.: BZ 4961E
- Application: ISUZU 3.5 tons (4JB1, 4JG2) (130 HP/ 150 HP) (4JG1) (4JH1)
- 經過特殊設計，可在安裝過程避免損傷油封。
- 油封料號：BZ 4961E
- 適用車種：ISUZU 3.5 噸卡車。
(4JB1, 4JG2) (130 HP/ 150 HP) (4JG1) (4JH1)



H.C.B-A1849

NEW

ISUZU (6UZ1) TRUCK CRANKSHAFT FRONT/REAR OIL SEAL INSTALLER

ISUZU (6UZ1) 卡車曲軸前 / 後油封安裝器 (3.5 噸)

- Oil seal installer for precise installation of crankshaft front/rear oil seal of Isuzu truck with 6UZ1 engine.
- Applicable engine : ISUZU 6UZ1 engine
- ISUZU OEM no. ref.: 109625-5403 (Front), 109625-5412 (Rear)
- 若無使用特殊工具安裝油封，容易造成油封安裝不均，導致漏油，使用此工具可快速又準確的安裝好油封。
- 適用車種：ISUZU 6UZ1 引擎
- ISUZU OEM 號碼：109625-5403 (前), 109625-5412 (後)



Backside

H.C.B-A1351

UD 350 (CK450) / UD 380 (CK451) TRUCK CRANKSHAFT REAR OIL SEAL INSTALLER

UD 350 (CK450)/ UD 380 (CK451) 卡車曲軸後油封安裝器

- To prevent the crankshaft rear oil seal from damaged when installing it.
- Application: UD 350 (CK450) over 20 tons ,UD 380 (CK451)
- Oil seal genuine no.: BZ5967E
- 正確使用本工具可避免安裝時損壞油封。
- 適用車種：UD350 (CK450) · 20 噸以上
UD380 (CK451)
- 油封料號：BZ5967E

VIDEO



H.C.B-B1351

UD 17 TONS TRUCK CRANKSHAFT REAR OIL SEAL INSTALLATION TOOL KIT

UD 17 噸曲軸後油封安裝工具組

- To prevent the crankshaft rear oil seal from damaged when installing it.
- Application: UD truck 17 TONS (1996-2011), FE6TB, FE6TC
- Oil seal genuine no.:BZ6273E
- 使用此工具在安裝時可避免損壞後油封。
- 適用車種：UD 17 噸卡車 (1996-2011), FE6TB, FE6TC
- 油封料號：BZ6273E

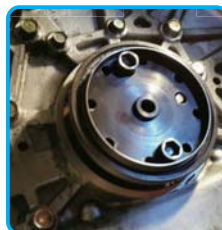

BZ6273E

H.C.B-A1066-5

UNIVERSAL AXLE EXTRACTOR (FOR TRUCKS ONLY)

萬用輪軸拔卸器 (卡車專用)

- Specification: Ø259 x 32 mm
- Screw specification: Ø30 x 6W
- Application: Japanese truck only. Ex:HINO, UD truck 180 pulley.
- 規格：Ø259 x 32 mm
- 螺絲規格：Ø30 x 6W
- 適用所有日系卡車前後輪軸拆卸，及 UD 卡車 180 皮帶盤



H.C.B-A1397

UD TRUCK (CW520, CW530) CRANKSHAFT REAR OIL SEAL INSTALLER

UD 卡車 (CW520, CW530) 曲軸後油封安裝器

- To prevent the crankshaft rear oil seal from damage when installing it. It is very easy to damage oil seal without using this tools.
- Application : UD TRUCK CW520 and CW530
- Oil Seal Genuine no.: BZ5333E → CW520 · BZ4938E → CW530



VIDEO



- 正確使用此工具可避免安裝時損壞油封。如果未使用此工具，在更換時容易損壞到油封。
- 適用車種：UD 卡車 CW520 及 CW530
- 油封料號：BZ5333E → CW520 · BZ4938E → CW530

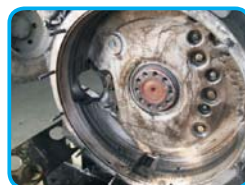

BZ 4938E



BZ 5333E

H.C.B-C1102

JAPANESE TRUCK BALL JOINT REMOVER (39 mm) PAT.M 362085

日系卡車球接頭拆卸器 (39 mm)

- On car maintenance.
- The best tool for removing truck ball joint which is in tie rod end, drag link and relay rod..etc.
- No damage to ball joint and related parts.
- Application: Over 4 tons Japanese trucks and most of heavy duty trucks.

- 可在車上維修。
- 可拆卸卡車橫拉桿和轉向拉桿上的球接頭。
- 不會損壞球接頭和相關零件。
- 適用車種：4 噸以上日系卡車，以及大部份重型卡車

※ Note:

- Make sure the dimension or specification of ball joint is matching before installing.
- Please lubricate the central bolt before using.
- The central bolt is consumable. Please replace it when losing the thread.
- The power is very strong when ball joint departs from related parts. To prevent the parts from falling down suddenly, please loose lock nut till its surface equal to the parts instead of to take it off.
- Please wear goggles while using this tool.



※ 注意事項：

- 連結球接頭拆卸器前，請先確認球接頭的尺寸或規格相符。
- 使用前請先潤滑中心螺絲。
- 中心螺絲是消耗品。當螺牙磨損時，請更換中心螺絲。
- 當球接頭拔出時的瞬間力道很大。為避免相關零件掉落，請先鬆開固定螺帽直到和零件表面一樣高、而不要完全取下。
- 使用本工具時，請戴護目鏡。

H.C.B-A1179

PITMAN ARM PULLER (Dr. 3/4", 62 mm)

方向機搖臂拔卸器 (Dr. 3/4", 62 mm)

5 / 22.5 / 23 / 0.74'

- Put it on steering mechanism pitman arm, then take pitman arm apart.
- It is time and labor saver which is different from traditional puller. It can also prevent pitman arm from damage.
- Application: 15 tons~35 tons of HINO, ISUZU, UD, FUSO truck and bus VOLVO (FM12)
- 將本工具放置到方向機搖臂上，然後取下搖臂。
- 省時、省力。和傳統式的拔卸器不同，不會損壞搖臂。
- 適用車種：15~35 噸的 HINO, ISUZU, UD, FUSO 卡車和遊覽車、VOLVO (FM12)



H.C.B-A1180

PITMAN ARM PULLER (Dr. 3/4", 47 mm)

方向機搖臂拔卸器 (Dr. 3/4", 47 mm)

6 / 23 / 23.5 / 0.72'

- Application: HINO, ISUZU, UD, FUSO, 8.8~10.5 tons truck
- It's time and labor saver which is different from traditional puller. It can also prevent pitman arm from damage.
- 適用車種：HINO, ISUZU, UD, FUSO, 8.8~10.5 噸的卡車
- 省時、省力。和傳統式的拔卸器不同，不會損壞搖臂。



H.C.B-B1181

ISUZU, FUSO, TOYOTA SPRING PIN METAL BUSH REMOVAL/INSTALLATION TOOL KIT (HYDRAULIC)

ISUZU, FUSO, TOYOTA 卡車彈簧銷拆裝工具組 (油壓式)

- To replace spring pin easily.
- Money and labor saver.
- Application: ISUZU, FUSO, TOYOTA medium-sized wagon and pickup

- 可輕易地更換卡車彈簧銷。
- 省錢、省力。
- 適用車種：ISUZU, FUSO, TOYOTA 中型貨車和小卡車

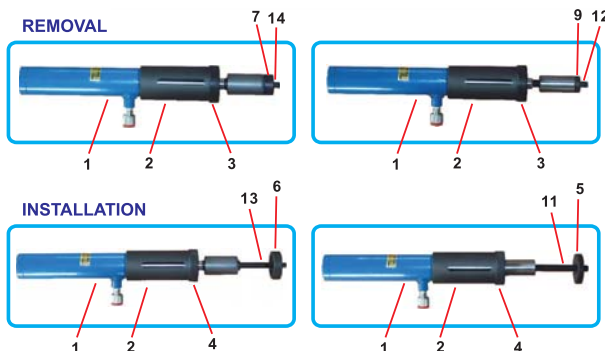
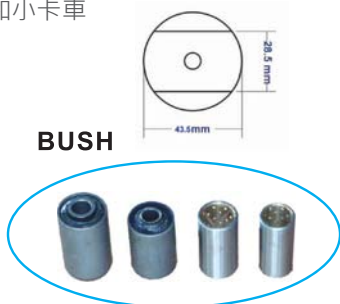

H.C.B-A1472

FUSO TRUCK TRANSMISSION/ SHAFT SLEEVE PULLER SET

FUSO 卡車變速箱 / 軸套拆卸組

Features:

- The best tool to remove FUSO transmission, and shaft sleeve, which won't damage the bearing, shaft sleeve, gear and related parts
- Easy to use, and can save time and money!

Technical information:

- Choose the appropriate accessory before operation.
- Put accessory puller into right place of bearing or shaft sleeve, then assemble main body, finally take out spare part by rotating central bolt.
- Application: FUSO truck

特性:

- 移除 FUSO 變速箱、軸套的最佳工具。不會損壞培林、軸套及相關零件
- 方便操作。省時更省錢!

使用方法:

- 操作前請選擇合適的配件。拆卸軸套前將拆卸塊放置軸套正確位置。將本體轉入。再轉動中心螺桿就可取出。
- 適用車種: FUSO 卡車



H.C.B-A1338

TRUCK VALVE REMOVER / INSTALLER

卡車汽門拆裝器

- To remove and install the valve of truck.
- Application: FUSO 3.5 tons, FUSO over 15 tons, Hino 750, ISUZU 180, ISUZU 200, VOLVO FM truck and SCANIA R400
- 可移除和安裝卡車氣門。
- 適用車種: FUSO 3.5 噸, FUSO 15 噸以上, HINO 75 ISUZU 180, ISUZU 200, VOLVO FM 和 SCANIA R 卡車
- Specification/ 規格:

Item No.	Size
A1338-1	M16 x P2.0 * M14 x P1.5 * 240 mm (L)
A1338-2	M16 x P2.0 * M12 x P1.75 * 240 mm (L)
A1338-3	M16 x P2.0 * M10 x P1.5 * 240 mm (L)
A1338-4	M16 x P2.0 * M10 x P1.25 * 240 mm (L)
A1338-5	M16 x P2.0 * M8 x P1.25 * 240 mm (L)



H.C.B-A1439

JAPANESE TRUCK WHEEL NUT SOCKET

日本卡車輪軸螺帽套筒

- For removing/ installing rear wheel nut.
- Material : SCM 440
- Application : JAPANESE TRUCKS, such as FUSO CANTER...etc
- 此套筒可拆裝後輪螺帽
- 材質 : SCM 440
- 適用車種 : 日系卡車。如: FUSO 堅達 ... 等

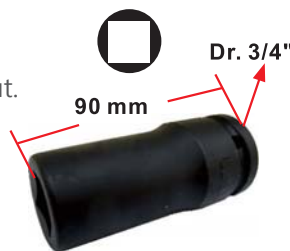

H.C.B-A1439-20



FUSO CANTER

Item no.	Dr.	SW	Length	N.W.	Application
A1439-17	3/4"	17mm	90 mm	0.55 KGS	
A1439-19	3/4"	19mm	90 mm	0.6 KGS	
A1439-20	3/4"	20mm	90 mm	0.612 KGS	FUSO CANTER
A1439-21	3/4"	21mm	90 mm	0.628 KGS	

H.C.B-A1170

TRUCK TORQUE-ROD BUSH REMOVAL / INSTALLATION TOOL KIT PAT. M307531

卡車扭力桿鐵套拆裝工具組

1 / 54.5 / 71 / 5.8'

- Application: BPW 12, 16 tons and Japanese trucks which have torque-rod.
- 適用車種：BPW 12 噸和 16 噸及日系卡車配備扭力桿的卡車

VIDEO



No.	Description
A1170-1	SPACE RING L358XW160XH151(m/m)
A1170-2	30 TON HYDRAULIC CYLINDER (STROKE 130 mm)
A1170-3	Φ103X98L RING PIVOT
A1170-4	Φ138X35L NUT (FIXED ONTO HYDRAULIC)(M88XP2.0)
A1170-5	INSERTION SUPPORT SLEEVE (Φ138X30L)
A1170-6	C-SHAPE FIXED BASE
A1170-7	TORQUE-ROD LOCK BAR (M14XP2.0)
A1170-8	TRAILER(L375XW180XH110mm)
A1170-9	AIR PUMP(OIL RESERVOIR) CAPACITY 1,600 C.C.)
A1170-10	SPACE RING OPTIONAL
A1170-11	REPLACEMENT BASE (Ø 127 x L 87)
A1170-12	INSTALLATION PLATE (Ø 69 x L83)
A1170-13	REMOVAL PLATE (Ø 82 x L 32)



TORQUE-ROD OF BPW
12/16 TONS TRUCK



13 12 11
Optional: For U.S.A truck
選購配件(美國卡車)

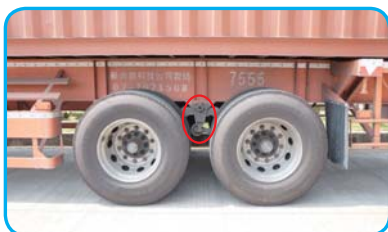

Ø70

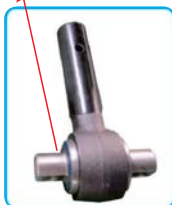

U.S.A truck
accessory

VIDEO

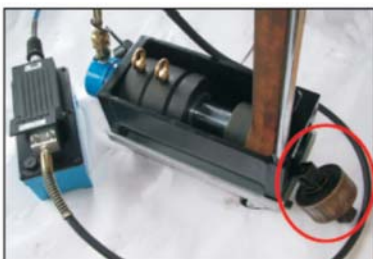
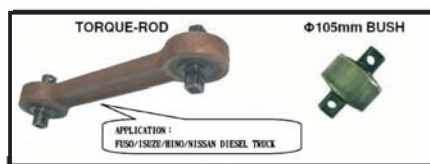

Installation: 安裝：

- Put torque-rod into the main body with necessary accessories.
- Stepping on the foot plate of air pump until the bush comes out.
(Don't obstruct the motion of air pump.)

- 把扭力桿和其他相關配件一起放入本體內。
- 輕踩氣動幫浦的腳踏板，直到鐵套被推出為止。
(請勿阻礙氣動幫浦的操作。)

Removal: 拆卸：

- *Stepping on the foot plate of air pump until the bush totally combined with Torque-Rod. (Don't obstruct the motion of air pump.)
輕踩氣動幫浦的腳踏板，直到鐵套整個安裝到扭力桿為止。
(請勿阻礙氣動幫浦的操作。)

H.C.B-A1415

HINO #700 BRAKE ADJUSTMENT WRENCH

HINO #700 煞車調整扳手

- To adjust the brake of HINO #700 truck
- Application : HINO #700-> after year 2004
#500-> after year 2010
- 用來調整 HINO # 700 煞車
- 適用車種 : HINO #700-> 2004 年以後
#500-> 2010 年以後



H.C.B-B1415

HINO #700 BRAKE ADJUSTMENT WRENCH

HINO #700 煞車調整扳手

- To adjust the brake of HINO #700 truck.
- Combine with A1415.
- Application : HINO #700
- 與 A1415 配合使用。
- 適用車種 : HINO # 700



H.C.B-A1495-1

ISUZU PETROL OIL MIST SEPARATE WRENCH (Dr. 1/2")

ISUZU 汽油油水分離器扳手 (Dr. 1/2")

- This wrench is designed to remove ISUZU petrol filter.
- Application: ISUZU FRR 90 engine
- 此工具用來拆卸油水分離器。
- 適用車種 : ISUZU FRR90 引擎

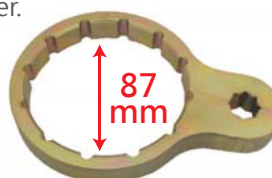

H.C.B-A1495-2

ISUZU PETROL OIL MIST SEPARATE SOCKET (Dr. 1/2")

ISUZU 汽油油水分離器套筒 (Dr. 1/2")

- This socket is designed for removing ISUZU petrol filter.
- Application: ISUZU FRR 90 engine& HINO 300 (EURO 5)
- 此工具用來拆卸油水分離器
- 適用車種 : ISUZU FRR90 引擎、
HINO 300(5 期)



H.C.B-C1491

HINO (JO8C/JO8E) TRUCK INJECTION NOZZLE PULLER/ INJECTION NOZZLE SLEEVE REMOVAL/ INSTALLATION TOOL KIT

HINO (JO8C/JO8E) 噴油嘴拆卸器 / 噴油嘴銅套拆裝工具組

- This tool kit can be used on the removal of both injector and injector sleeve without any other tool or part.
- 說明：此工具為 H.C.B-A1491 加上 H.C.B-B1491, 使用此組工具，可於拆除噴油嘴後，直接拆卸噴油嘴銅套，不須搭配其他工具，即可完成兩樣工作

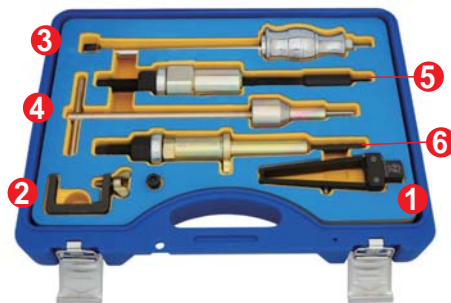

H.C.B-B1491

HINO (JO8C/JO8E) TRUCK INJECTION NOZZLE SLEEVE REMOVAL/INSTALLATION TOOL KIT

HINO (JO8C/JO8E) 噴油嘴銅套拆裝工具組

- Application: HINO (JO8C/JO8E) truck.
- This tool is designed to remove/ install the injector cooper sleeve.
- Sleeve no. ref: 111761190
- 適用車種：HINO (JO8C/JO8E) 卡車
- 此工具是用來拆卸及安裝噴油嘴銅套。
- 銅套料號：111761190



Sleeve no. ref: 111761190
銅套料號: 111761190

H.C.B-A1491

HINO (JO8C/JO8E) TRUCK INJECTION NOZZLE PULLER

HINO (JO8C/JO8E) 卡車噴油嘴拆卸器

- This puller is designed to remove the injector nozzles.
- Application: HINO truck 300、500、700
- 此工具用來拆卸噴油嘴。
- 適用車種：HINO 卡車 300、500、700



HINO JO8E
(NEW)



HINO JO8E
(OLD)

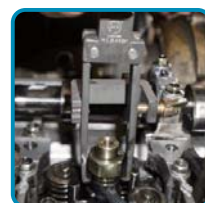
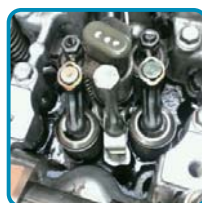

H.C.B-A1628

FUSO CANTER FUEL FILTER WRENCH (EURO 5) (Dr. 1/2") (50 mm)

FUSO 堅達柴油濾芯扳手 (五期環保) (Dr. 1/2") (50 mm)

- To remove the oil filter and drain fuel from the filter.
- Application: FUSO CANTER (Euro 5), MITSUBISHI NEW CANTER: SERIES 5 (3.5 TONS)

- 說明：移除機油濾芯蓋
- 適用車種：FUSO 堅達 (5 期) 、三菱新堅達 5 期 3.5 噸
- 尺寸：Dr. 1/2" x 50 mm.



H.C.B-A1520

Dr. 1", COMBINATION BUDD WHEEL IMPACT SOCKET (1-1/2" x13/16", 41x21 mm, 38x20 mm, 35x17 mm, 38x19 mm) (5PCS)

Dr. 1" 卡車輪胎套筒組 (1-1/2" x13/16", 41x21 mm, 38x20 mm, 35x17 mm, 38x19 mm) (5PCS)

- **CAUTION:** Please always wear safety goggles when using impact equipment. Do not hold socket while in using.
- Size: 1/2"x13/16", 41x21 mm, 38x20 mm, 35x17 mm, 38x19 mm
- Quality budd wheel impact sockets are made from chrome molybdenum and designed for heavy-duty using when working on front and rear axle wheels.
- **Feature/Benefits**
- Each socket distinctly etched with size which can be read easily.
- 38x19 mm for TOYOTA, MAZDA, ISUZU, HINO, DAIHATSU
- 35x17 mm for NISSAN (~3t), MAZADA (~2t), ISUZU (~2t)
- 38x20 mm for MITSUBISHI (~1t)
- 41x21 mm for NISSAN (4t~), MITSUBISHI (2t~), ISUZU (4t~) HINO (4t~)
- Exotic trucks with dual rear wheels 1-1/2" socket for domestic trucks with dual rear wheels

- 注意：在使用氣動工具時，請穿戴護目鏡。在使用過程中，不要緊抓套筒。
- 尺寸：1/2"x13/16", 41x21 mm, 38x20 mm, 35x17 mm, 38x19 mm
- 此氣動套筒特別用在重型卡車，可用來拆卸前輪及後輪螺絲

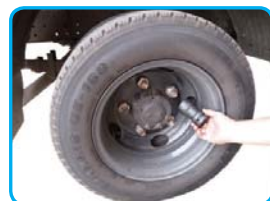

H.C.B-A2313

Dr. 1" TRUCK WHEEL SOCKET (12PT) (41x21 mm)

Dr. 1" 卡車輪胎套筒 (12 角) (41x21 mm)

- Size: L=90, D1=48, D2=57, L1=15, L2=23.7 (mm) (12PT)
- 尺寸：長 =90, D1=48, D2=57, L1=15, L2=23.7 (mm) (12 角)



H.C.B-B2313

Dr. 1/2" TRUCK WHEEL SOCKET (12PT) (41x21 mm)

Dr. 1/2" 卡車輪胎套筒 (12 角) (41x21 mm)

- Size: L=110, D=56, L1=15 (mm) (12PT)
- 尺寸: 長: 110, D: 56, L1: 15, 12 角



H.C.B-A1579

HINO (E13C) CRANKSHAFT FRONT OIL SEAL INSTALLER (700)

HINO (E13C) 曲軸前油封安裝工具組 (700 型)

- This tool is designed for preventing oil seal from damaged when installing it.
- Application: HINO (E13C) truck 390/420/446 HP (700)
- Oil seal genuine no.: BZ5221E
- Oil seal size: d:96 x Ø:131 x t:13 mm

- 本工具經過特殊設計，在安裝 HINO 曲軸前油封時，可避免損傷油封
- 適用車種：HINO(E13C) 390/420/446 HP(700 型)
- 油封料號：BZ5221E
- 油封尺寸：d:96 x Ø:131 x t:13 mm



Optional used on K13 C TV
(選購配件)

H.C.B-B1579

HINO (E13C) CRANKSHAFT REAR OIL SEAL INSTALLER (700)

HINO (E13C) 曲軸後油封安裝工具組 (700 型)

- This tool is designed for preventing oil seal from damaged when installing it.
- Application: HINO (E13C) truck 390/420/446 HP (700)
- Oil seal genuine no.: BZ5222F
- Oil seal size :d:125 x Ø:177 x t: 15 mm

- 本工具經過特殊設計，在安裝 HINO 曲軸後油封時，可避免損傷油封
- 適用車種：HINO(E13C) 390/420/44HP(700 型)
- 油封料號：BZ5222F
- 油封尺寸：d:125 x Ø:177 x t:15 mm



H.C.B-C1579

HINO (F20C) TRUCK CRANKSHAFT FRONT OIL SEAL INSTALLER (21 TONS)

HINO (F20C) 曲軸前油封安裝器 (21 噸)

- This tool is designed for preventing oil seal from damaged when installing it.
- Application: HINO (F20C)
- Oil seal genuine no.: BZ5221E
- 本工具經過特殊設計，在安裝 HINO 曲軸前油封時，可避免損傷油封。
- 適用車種：HINO (F20C)
- 油封料號：BZ5221E

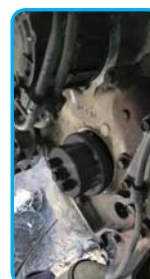

H.C.B-D1579

NEW

HINO (K13C) TRUCK CRANKSHAFT FRONT OIL SEAL INSTALLER

HINO (K13C) 卡車曲軸前油封安裝工具

- This tool is designed for preventing oil seal from damaged when installing it.
- Application: HINO (K13C) truck
- 本工具經過特殊設計，在安裝 HINO 曲軸前油封時，避免損傷油封。
- 適用車種：HINO (K13C) 卡車



H.C.B-A1586

HINO 11 TONS WHEEL SPEED SENSOR REMOVAL/INSTALLATION TOOL KIT

HINO 11 噸輪速感應片拆裝工具

- This tool is used to remove and install wheel speed sensor.
- On car maintenance.
- Application: HINO 11 tons truck
- 此工具是用來拆裝輪速感應片
- 適用車種：HINO 11 噸卡車
- 可在車上拆裝感應片



VIDEO



Removal



Installation



H.C.B-A1625

HINO (P11C/K13C) CRANKSHAFT REAR OIL SEAL INSTALLATION TOOL KIT

HINO (P11C/K13C) 曲軸後油封安裝工具組

- To prevent the crankshaft rear oil seal from damaged when installing it.
- Application:
HINO P11C (330 HP) (1999-2002)
HINO K13CTV (360 HP) (1999-2002)
- Oil seal genuine no.: BZ5377F
- 說明：此工具可輕鬆安裝油封，過程不會傷害到油封或零件。
- 適用車種：
HINO P11C (330 HP) (1999-2002)
HINO K13CTV (360 HP) (1999-2002)
- 油封料號：BZ5377F

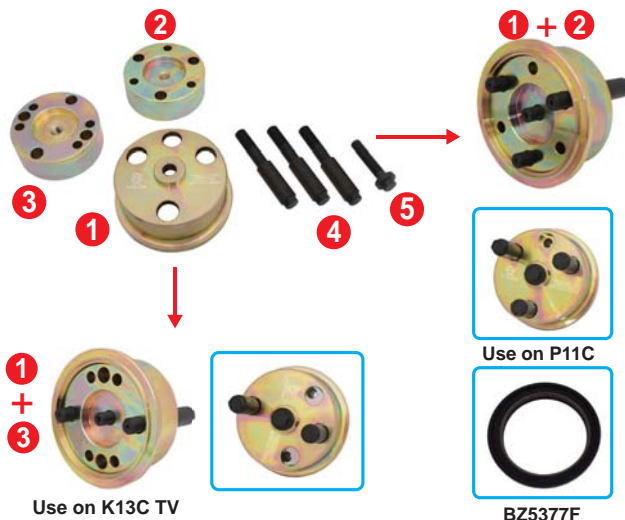

Japanese Truck Repair Tool

H.C.B-B1059

UNIVERSAL CALIPER PRESSURE TOOL (FOUR PISTONS)

通用型分泵回復器 (四活塞)

- An universal tool for pressing caliper pistons back into caliper housings with special broadened steel board.
- 工具內建培林，使用時簡便省力。特殊加寬鋼板，可輕易將移位的活塞推回原位。



H.C.B-A1635

ISUZU 35 TONS (6WG1/6WA1) CRANKSHAFT FRONT OIL SEAL/ FAN AXLE OIL SEAL INSTALLER

ISUZU 35 噸 (6WG1/6WA1)
曲軸前油封及風扇軸油封安裝工具

VIDEO



Character:

- This tool is specially designed for preventing the oil seal from damaged when installing it.
- Oil seal genuine no.: BZ4837 G, BZ5016 E
- Application : ISUZU 35 tons truck
ISUZU 6WZ1 (370P)
- 此工具可以安裝風扇軸油封和曲軸前油封兩種油封。讓你在安裝油封過程不會損壞到油封及零件。
- 油封料號：BZ4837 G, BZ5016 E
- 適用車種：ISUZU 35 噸
ISUZU 6WZ1 (370P) 前油封

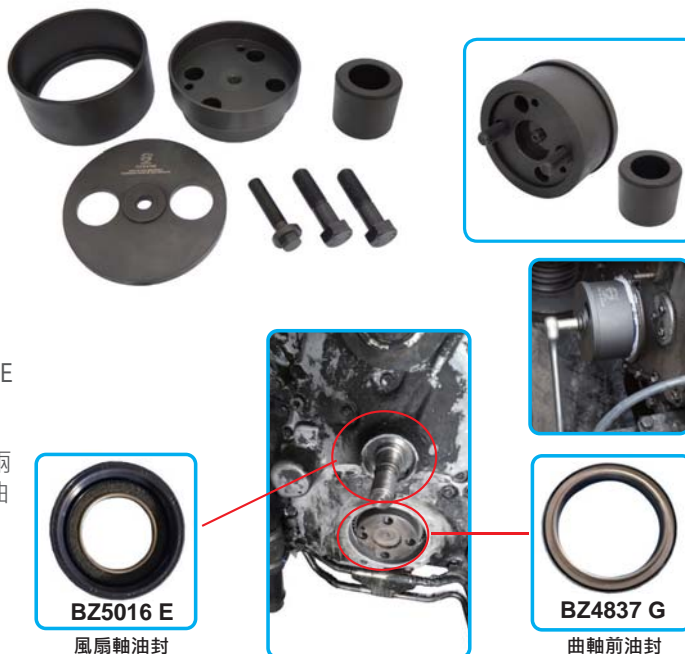

BZ5016 E
風扇軸油封

BZ4837 G
曲軸前油封

H.C.B-A1726

ISUZU (4JJ1) CRANKSHAFT FRONT OIL SEAL INSTALLER (3.5 TONS)

ISUZU (4JJ1) 曲軸前油封安裝器 (3.5 噸)

- This tool is specially designed for quick and precise installation, and can prevent the oil seal from damaged while installing it.
- Oil seal genuine no.: XZ1262E, 8-98158110-0
- Size: 73x96x15
- Application: ISUZU ELF 3.5 tons (4JJ1) (150HP)(After 2011)
ISUZU NPR DIESEL (4JJ1) (LFB)
SINGLE CAB (2011- 2015) ISUZU (2011~)

■ 此工具可準確、快速的將油封安裝完成，並可在安裝時，避免損壞油封。

■ 油封原廠料號：XZ1262E, 8-98158110-0

■ 尺寸：73x96x15

■ 適用範圍：ISUZU ELF 3.5 tons (4JJ1) (150HP)(After 2011)
ISUZU NPR DIESEL (4JJ1) (LFB) SINGLE CAB
(2011- 2015) ISUZU (2011~)



Oil seal genuine no.:
XZ1262E

H.C.B-B1726

ISUZU (4JJ1) TRUCK CRANKSHAFT REAR OIL SEAL INSTALLER (3.5 TONS)

ISUZU (4JJ1) 卡車曲軸後油封安裝器 (3.5 噸)

- This tool is specially designed for quick and precise installation, and can prevent the oil seal from damaged while installing it.
- Oil seal genuine no.: BZ4962E, 8-97071561-1
- Application: ISUZU ELF 3.5 tons (4JJ1) (150HP)
(After 2011) ISUZU NPR DIESEL (4JJ1)
(LFB) SINGLE CAB (2011- 2015) ISUZU
(2011~)

■ 此工具可準確、快速的將油封安裝完成，並可在安裝時，避免損壞油封。

■ 油封原廠料號：BZ4962E, 8-97071561-1

■ 適用範圍：ISUZU ELF 3.5 tons (4JJ1) (150HP)(After 2011)
ISUZU NPR DIESEL (4JJ1) (LFB) SINGLE CAB
(2011- 2015) ISUZU (2011~)



H.C.B-A1673

HINO (17 TONS) TRUCK BRAKE BOOSTER SOCKET

HINO (17 噸) 卡車煞車增壓輔助器套筒

- Instructions:
Step1. Use the socket to turn the oil seal cover to twist and destroy the old oil seal, and then the oil seal cover will be loose.
Step2. Take both the old oil seal and oil seal cover out.
Step3. Fit the new oil seal, install the oil seal cover, and replacement is completed.
- Application: HINO 17 tons

■ 操作：使用套筒旋轉油封外蓋將舊油封破壞，油封破壞後，油封外蓋會鬆脫，將油封外蓋與舊油封取出，更換新油封後，將油封外蓋安裝回去，即完成工作

■ 適用車種：HINO 17 噸



H.C.B-C1681

NEW

FUSO/ HINO REAR BRAKE SHOES INSTALLATION TOOL KIT

FUSO/ HINO 後輪煞車片安裝工具組

- Instructions:
While installing the brake shoes, use tool No. 2 first to push the pistons of slave cylinder back to its position, afterwards fit tool No.1 on the new brake shoes, turn tool No. 1 to push the brake shoes outwards, fit brake shoes back to the position, loosen tool No. 1 to loosen the brake shoes, and brake shoes installation is completed.
- Application: FUSO over 15 tons
HINO over 15 tons
- 說明：安裝煞車片時，首先使用 2 號工具將分泵活塞推回、復位，再使用 1 號工具撐開煞車片，之後將煞車片裝回、鬆開煞車片即完成安裝。
- 適用車種：FUSO 15 噸以上
HINO 15 噸以上



H.C.B-A1681

FUSO/ HINO TRUCK REAR BRAKE SHOES INSTALLATION TOOL KIT

FUSO/ HINO 卡車後輪煞車片安裝工具組

- Instructions:
While installing the brake shoes, use tool No. 2 first to push the pistons of slave cylinder back to its position. Afterwards fit tool No.1 on the new brake shoes, turn tool No. 1 to push the brake shoes outwards, fit brake shoes back to the position, loosen tool No. 1 to loosen the brake shoes, and brake shoes installation is completed.
- Application: FUSO over 15 tons
HINO over 15 tons
- 說明：安裝煞車片時，首先使用 2 號工具將分泵活塞推回、復位，再使用 1 號工具撐開煞車片，之後將煞車片裝回、鬆開煞車片即完成安裝。
- 適用車種：FUSO 15 噸以上
HINO 15 噸以上



H.C.B-A2018

MITSUBISHI CANTER 3.5 TONS/ FUSO OIL FILTER WERNCH (Dr. 1/2", 15 POINTS, 100 mm)

三菱堅達 3.5 噸 /FUSO 機油芯扳手 (Dr. 1/2", 15 角, 100 mm)

30 / 13.5 / 15 / 1.8'

- To remove oil filter.
- Application: Mitsubishi Canter 3.5 tons/FUSO
- Size: Dr. 1/2", 15 points, 100 mm
- Genuine no.: ME013343

- 可移除機油芯
- 適用車種：三菱堅達 3.5 噸貨車
- 尺寸：Dr. 1/2", 15 角, 100 mm
- 機油芯料號：ME013343



H.C.B-A2018-1

MITSUBISHI NEW CANTER 8.8 TONS OIL FILTER WERNCH (TURBO)(DR. 1/2", 15 POINTS, 101 mm)

三菱新堅達 8.8 噸機油芯扳手 (Dr. 1/2", 15 角, 101 mm)

30 / 13.5 / 15 / 1.8'

- To remove oil filter.
- Application: Mitsubishi New Canter 8.8 tons
Delica 2200 c.c./2500 c.c.
- Size: Dr. 1/2", 15 points, 101 mm
- Genuine no.: ME013307
- 可移除機油芯
- 適用車種：三菱堅達 8.8 噸貨車、得利卡 2200 c.c./2500 c.c.
- 尺寸：Dr. 1/2", 15 角, 101 mm
- 機油芯料號：ME013307

Dr. 1/2"



H.C.B-A2018-2

HINO 15 TONS OIL FILTER WRENCH (Dr. 1/2", 16 POINTS, 108 mm)

HINO 15 噸機油芯扳手 (Dr. 1/2", 16 角, 108 mm)

30 / 15.9 / 17 / 1.49'

- Size: Dr. 1/2", 16 points, 108 mm
- Application: Hino 15 tons before 2006
- 尺寸：Dr. 1/2", 16 角, 108 mm
- 適用車種：HINO 15 噸 2006 年前的貨車

Dr. 1/2"



H.C.B-A2018-5

ISUZU ELF OIL FILTER WRENCH (Dr. 1/2", 15 POINTS, 89 mm)

ISUZU 一路發機油芯扳手 (Dr. 1/2", 15 角, 89 mm)

30 / 11.7 / 13 / 1.8'

- Size: Dr. 1/2", 15 points, 89 mm
- Well-designed tool to save time.
- 尺寸：Dr. 1/2", 15 角, 89 mm
- 經過特殊設計的工具·節省時間·提高效率。

Dr. 1/2"



H.C.B-A2018-11

FUSO NEW CANTER 3.5/11 TONS (EURO 4) DIESEL FILTER WRENCH (Dr. 1/2", 109 mm)

FUSO 新堅達 3.5/11 噸 (4 期) 柴油濾芯扳手 (Dr. 1/2", 109 mm)

- Application: Mitsubishi all New Canter Euro 4, 3.5 tons, 6.7 tons, 6.9 tons and 14.8 tons.
- To loosen fuel filter and drain oil out.
- Before tighten filter, make sure to clean the surface and the trench of o-ring on the filter base carefully.
- Size: Dr. 1/2", 16 points, 109mm
- N.W.: 0.644 kgs
- 適用車種：三菱新堅達四期環保 3.5 噸、6.7 噸、6.9 噸和 14.8 噸柴油車
- 可鬆開燃油濾清器·並將油排光。
- 在鎖回燃油濾清器前·請確定底部O型環溝槽已經清理乾淨。
- 尺寸：Dr. 1/2" · 16 角 · 109 mm
- 淨重：0.644 公斤



H.C.B-A2018-12

MITSUBISHI ALL NEW CANTER DIESEL OIL AND WATER SENSOR WRENCH (12 POINTS, 54 mm)

三菱新堅達柴油車油水感應器扳手 (12 角, 54 mm)

- Application: Mitsubishi all New Canter Euro 4, 3.5 tons, 6.7 tons and 6.9 tons.
- To loosen oil and water filter and drain them out.
- Before tighten filter, be sure to clean the surface and the trench of o-ring on the filter base carefully.
- Size: 12 points, 54 mm
- N.W.: 0.224 kgs

- 適用車種：三菱新堅達四期環保 3.5 噸、6.7 噸和 6.9 噸柴油車
- 可鬆開濾油芯及濾水芯、並將油和水排光。
- 在鎖回濾芯前，請確定底部O型環溝槽已經清理乾淨。
- 尺寸：12 角·54 mm
- 淨重：0.224 公斤



H.C.B-A2018-13

UD (EURO 5)/ ISUZU/ HINO 17 TONS OIL FILTER WRENCH (EURO 4) (Dr. 1/2", 16 POINTS, 118 mm)

UD (五期)/ ISUZU/ HINO 17 噸機油芯扳手 (四期環保) (Dr. 1/2", 16 角, 118mm)

- Size: Dr. 1/2", 16 points, 118 mm
- N.W.: 0.6 kgs
- Application: ISUZU、HINO 17 TONS、UD(EURO 5)
- 尺寸：Dr. 1/2" · 16 角 · 118 mm
- 淨重：0.6 公斤
- 適用車種：ISUZU、HINO 17 噸、五期環保

Dr. 1/2"



H.C.B-A2018-14

MITSUBISHI VERYCA (1200 c.c.) OIL FILTER WRENCH (EURO 4) (14 POINTS, 66.5 mm)

中華菱利 (1200 c.c.) 機油芯扳手 (四期)(14 角, 66.5mm)

- Genuine no.: MD349105
- Application: Mitsubishi Veryca 1200 c.c.
- Subaru Forester 2.0 / 2.5 L (2011-2016)
- Subaru Impreza 2.0 L (2012-2016)
- Subaru XV Crosstrek 2.0 L (2013-2016)
- Subaru XV Crosstrek 2.0 L HYBRID (2014-2016)
- N.W.: 0.3 kgs

- 原廠料號：MD349105
- 適用車種：中華菱利 1200 c.c.
- 淨重：0.3 公斤

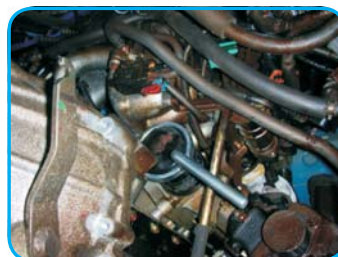

H.C.B-A2018-17

FUSO (6.5/6.8/7.7 TONS) TRUCK OIL FILTER WRENCH (Dr. 1/2", 16 POINTS, 106.5 mm)

FUSO(6.5/6.8/7.7 噸) 卡車機油芯扳手 (Dr. 1/2", 16 角, 106.5 mm)

- Application : FUSO 6.5/6.8/7.7 tons truck
- 適用車種：FUSO 6.5/6.8/7.7 噸卡車



H.C.B-A2018-18

FUSO (10.5~17 TONS) TRUCK OIL FILTER WRENCH (Dr. 1/2", 15 POINTS, 119 mm)

FUSO(10.5~17 噸) 卡車機油芯扳手
(Dr. 1/2", 15 角, 119 mm)

- Genuine no.: ME 074013
- Application: FUSO 10.5~17 tons truck
- 原廠料號：ME 074013
- 適用車種：FUSO 10.5~17 噸卡車

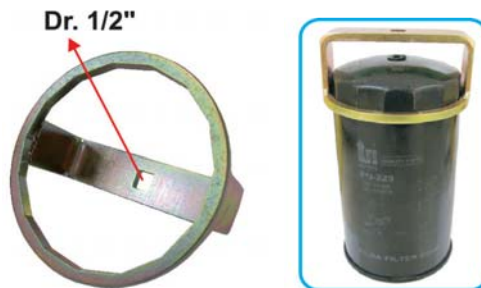

H.C.B-A2018-20

FUSO TRUCK OIL MIST SEPARATOR WRENCH (Dr. 1/2", 8 RIBS, 109 mm)

FUSO 卡車油水分離器扳手 (Dr. 1/2", 8 齒, 109 mm)

- Application: FUSO 380 over 17 tons (Engine no. 6M70) and bus. MITSUBISHI all NEW CANTER eco-4 3.5, 6.7 and 6.9 tons. ISUZU 17 TONS (Series 4/5) & MITSUBISHI NEW CANTER (Series 5) 6.7/6.9 TONS
- 適用車種：FUSO 380 卡車 17 噸以上 (引擎號碼：6M70) 及遊覽車。三菱新堅達 4 期環保 3.5、6.7 和 6.9 噸。Isuzu 17 噸 4/5 期環保 & 三菱新堅達 5 期 6.7/6.9 噸

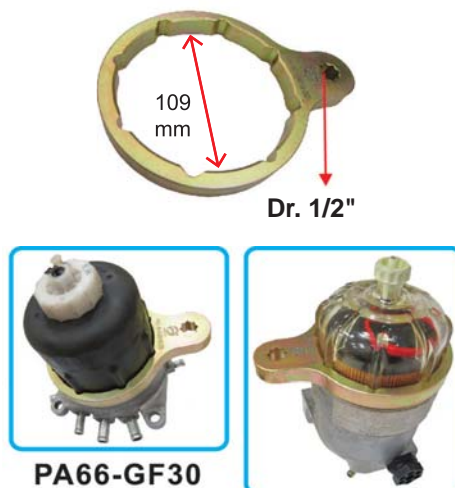

H.C.B-A2018-21

HINO TRUCK/ISUZU (3.5 TONS) (EURO 4/ NL EURO 5) OIL MIST SEPARATOR WRENCH (Dr. 1/2", 8 RIBS, 107mm)

HINO 卡車 /ISUZU 3.5 噸 (四期環保車 /NL 五期環保車)
油水分離器扳手 (Dr. 1/2", 8 齒, 107mm)

- Application: HINO truck year 2003~2006 or after year 2010/ ISUZU 3.5 tons (Euro 4)
- Genuine no.: 103251, S23401-11840-A
- 適用車種：2003-2006 年或 2010 年後的 HINO 卡車 /ISUZU 3.5 噸 (四期環保車)
- 機油芯料號：103251, S23401-11840-A

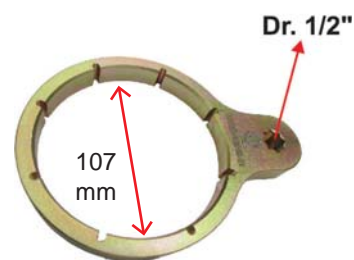

H.C.B-A2018-22

ISUZU (4.9~7.9 TONS) TRUCK OIL FILTER WRENCH (Dr. 1/2", 15 POINTS, 118 mm)

ISUZU (4.9~7.9 噸) 卡車機油芯扳手
(Dr. 1/2", 15 角, 118 mm)

- Application: ISUZU (4.9 TONS~7.9 TONS) TRUCK
- 適用車種 : ISUZU (4.9~7.9 噸) 卡車



H.C.B-A2018-23

HINO(EURO 4/5) (3.5 ~7.4 TONS)TRUCK OIL FILTER WRENCH (Dr. 1/2", 15 POINTS, 101.5mm)

HINO(四期 / 五期) (3.5 ~7.4 噸) 卡車機油芯扳手
(Dr. 1/2", 15 角, 101.5mm)

- Application: HINO (EURO 4/5) (3.5 tons~7. tons) truck
- 適用車種 : HINO(四期 / 五期)(3.5~7.4 噸) 卡車



H.C.B-A2018-24

FUSO (6D16) MEDIUM-SIZED TRUCK OIL FILTER WRENCH (Dr. 1/2", 16 POINTS, 123 mm)

FUSO (6D16) 中型卡車機油芯扳手
(Dr. 1/2", 16 角, 123 mm)

- Oil Filter no.: ME130968/ME074013
- Application: 2005-2008 FK200
2005-2007 FM260/AS
2005-2008 FM330
2008 FK260

- 機油芯料號 : ME130968/ME074013
- 適用車種 : 2005-2008 FK200 2005-2007 FM260/AS
2005-2008 FM330 2008 FK260



Oil filter no.: ME130968 ME074013

H.C.B-A2018-25

FUSO (6D16) 11 TONS TRUCK REMOVAL TOOL FOR FUEL FILTER (Dr. 1/2", 15 POINTS, 93 mm)

FUSO (6D16) 11 噸卡車柴油濾芯扳手
(Dr. 1/2", 15 角, 93 mm)

- Application: FN428, FP413, 415, 418 / FT413, 415 / FU413, 415, 418, 478, K303, 405 / FS418 / MU515
- Oil Filter no. : ME056670
- Size: Dr. 1/2" , 15 Points, 93 mm
- 適用車種 : FN428, FP413, 415, 418 / FT413, 415 / FU413, 415, 418, 478, K303, 405 / FS418 / MU515
- 機油芯料號 : ME056670
- 尺寸 : Dr. 1/2", 15 角, 93 mm



H.C.B-A2018-28

ISUZU 3.5 TONS (EURO 4/5) TRUCK DIESEL FILTER WRENCH (Dr. 1/2", 12 RIBS, 100 mm)

ISUZU 3.5 噸 (四 / 五期環保) 卡車柴油濾芯扳手
(Dr. 1/2", 12 齒, 100 mm)

- Instruction: This tool is used to remove the diesel filter.
- Application: ISUZU 3.5 TONS (EURO 4/5)
- 說明：此工具用來拆卸柴油濾芯
- 適用車種：ISUZU 3.5 噸 (4/5 期環保) 卡車



H.C.B-A2018-29

HINO (3.5/7.5/8.5 TONS) (EURO 5) TRUCK DIESEL FILTER WRENCH (15 POINTS, 101 mm)

HINO (3.5/7.5/8.5 噸) (五期) 卡車柴油濾芯扳手
(15 角, 101 mm)

- Instruction: This tool is used to remove the diesel filter.
- Application: HINO (3.5/ 7/ 8.5 tons) (Euro 5) truck
- Diesel filter no.: 23304-EV021
- 說明：此工具用來拆卸柴油濾芯
- 適用車種：HINO (3.5/7.5/8.5 噸) (五期) 卡車
- 柴油濾芯：23304-EV021

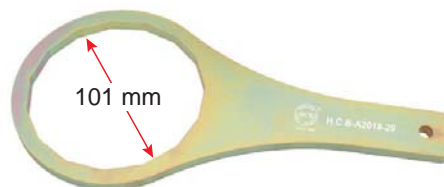

H.C.B-A2018-30

HINO (3.5/7.5/8.5 TONS) (EURO 5) TRUCK DIESEL OIL MIST SEPARATE WRENCH (Dr. 1/2", 12 RIBS, 86 mm)

HINO (3.5/7.5/8.5 噸) (五期) 卡車柴油油水分離器扳手
(Dr. 1/2", 12 齒, 86 mm)

- Size: Dr. 1/2", 12 ribs, 86 mm
- Application: HINO (3.5/7.5/8.5 TONS) (EURO 5) truck
- 尺寸：Dr. 1/2", 12 齒, 86 mm
- 適用車種：HINO (3.5/7.5/8.5 TONS) (EURO 5) 卡車



Optional: H.C.B-A1495-2
for removing the adaptor.
選購配件: H.C.B-A1495-2

H.C.B-A2018-31

NEW

FUSO (6D 16/ 17) TRUCK OIL FILTER WRENCH (Dr. 1/2", 18 POINTS, 124 mm)

FUSO (6D 16/ 17) 卡車機油芯扳手 (Dr. 1/2", 18 角, 124 mm)

- Feature: Use H.C.B-A2018-31 to loosen the filter and drain oil out.
- Application: FUSO (6D 16/ 17) truck
- 特色: 使用 H.C.B-A2018-31 來鬆開機油芯並將廢油排出
- 適用車種: FUSO (6D 16/ 17) 卡車



H.C.B-A2130

MITSUBISHI CANTER DIESEL OIL FILTER REMOVER/ INSTALLER

三菱堅達柴油車機油芯拆裝工具

- This tool set includes H.C.B-A2130-1 diesel oil filter wrench x 1 and H.C.B-A2130-2 diesel oil filter switch wrench x 1
- Application: MITSUBISHI CANTER and most of diesel engine.
- Genuine no.: MB 220900
- 本工具組包含 H.C.B-A2130-1 柴油機油芯扳手、H.C.B-A2130-2 柴油機油芯開關扳手各 1 支
- 適用車種: 三菱堅達及大部份柴油引擎貨車
- 原廠料號: MB 220900



H.C.B-A1791

NEW

FUSO (8.8 / 10.4 TONS) CRANKSHAFT FRONT OIL SEAL PULLEY REMOVER

三菱 FUSO (8.8/ 10.4 噸) 曲軸前油封皮帶盤拆卸工具

- Use H.C.B-A1791 can easy to move rusting pulley, after removing middle screw of pulley.
- Put H.C.B-A1791 in the holes of pulley to removes pulley.
- 在拆除皮帶盤的中心螺絲之後, 可使用此工具輕易卸下生鏽的皮帶盤
- 將此工具置入皮帶盤孔中, 以拆卸皮帶盤



H.C.B-A1792

NEW

FUSO (4D 33) TRUCK CRANKSHAFT REAR OIL SEAL INSTALLER

FUSO (4D 33) 卡車曲軸後油封安裝工具

- To prevent the crankshaft rear oil seal from damaged when installing it.
- Application: FUSO 4D33
- Oil seal genuine no: BZ4603E
- Dimension of the oil seal: 100 x 124 x 13.3 mm
- 若無使用特殊工具安裝油封, 容易造成油封安裝不均, 導致漏油。使用此工具可快速又準確的安裝好油封。
- 適用車種: FUSO 4D33
- 油封料號: BZ4603E
- 油封尺寸: 100 x 124 x 13.3 mm



H.C.B-A1793

NEW

FUSO (6D 17) TRUCK CRANKSHAFT REAR OIL SEAL INSTALLER

FUSO (6D 17) 卡車曲軸後油封安裝工具

- To prevent the crankshaft rear oil seal from damaged when installing it.
- Application: FUSO (6D 17) truck
- 若無使用特殊工具安裝油封，容易造成油封安裝不均，導致漏油，使用此工具可快速又準確的安裝油封。
- 適用車種：FUSO (6D 17) 卡車



H.C.B-A2018-33

NEW

ISUZU (6HK1) (3.5 TONS) 150P TRUCK DIESEL OIL MIST SEPARATOR WRENCH (Dr. 1/2", 8 RIBS, 106 mm)

ISUZU (6HK1) (3.5 噸) 150P 卡車柴油油水分離器扳手 (Dr. 1/2", 8 齒, 106 mm)

- This tool is designed for removing filter.
- Application: ISUZU 6HK1 (3.5 tons) 150P truck
- Size: Dr. 1/2", 8 RIBS, 106 mm
- 使用 H.C.B-A2018-33 來鬆開機油芯並將廢油排出
- 適用車種：ISUZU 6HK1 (3.5 噸) 150P 卡車
- 尺寸：(Dr. 1/2", 8 齒, 106 mm)



H.C.B-A2018-34

NEW

FUSO 17 TONS TRUCK OIL FILTER WRENCH (Dr. 1/2", 18 POINTS, 123.2 mm)

FUSO 17 噸卡車機油芯扳手 (Dr. 1/2", 18 角, 123.2 mm)

- Feature: Use H.C.B-A2018-34 to loosen the filter and drain oil out.
- Application: FUSO 17 tons truck
- 特色：使用 H.C.B-A2018-34 來鬆開機油芯並將廢油排出
- 適用車種：FUSO 17 噸卡車



H.C.B-A2018-36

NEW

ISUZU 11 TONS TRUCK DIESEL OIL MIST SEPARATOR WRENCH (Dr. 1/2", 8 RIBS, 118.7 mm)

ISUZU 11 噸卡車柴油油水分離器扳手 (Dr. 1/2", 8 齒, 118.7 mm)

- This tool is designed for removing ISUZU 11 tons truck oil mist separator.
- Application: ISUZU 11 tons truck, FR Euro 5
- 特色：此工具設計於將油水分離器拆下。
- 適用車種：ISUZU 11 噸卡車，FR 5 期



H.C.B-A2018-37

NEW

MITSUBISHI/ NISSAN UD TRUCK OIL FILTER WRENCH (Dr.1/2", 6 POINTS, 124 mm)

MITSUBISHI/ NISSAN UD 卡車機油芯扳手 (Dr.1/2", 6 角, 124 mm)

- Feature: Use H.C.B-A2018-37 to loosen the filter and drain oil out.
- Application: MITSUBISHI and UD truck, FUSO 6D16
- Oil filter no.:
Mitsubishi: ME130968, ME074013, ME074235
Nissan UD: 15201-Z9009, 15201-Z9014, AY100-UD501, AY100-MT501, NU8201

- 特色：使用 H.C.B-A2018-37 來鬆開機油芯並將廢油排出
- 適用車種：MITSUBISHI 和 UD 卡車, FUSO 6D16
- 機油芯料號：
Mitsubishi: ME130968, ME074013, ME074235
Nissan UD: 15201-Z9009, 15201-Z9014, AY100-UD501, AY100-MT501, NU8201



H.C.B-A1814

NEW

UD CWB5E TRANSMISSION REMOVAL TOOL KIT

UD CWB5E 變速箱分解工具組

- This tool is designed to remove the UD transmission, saving time and labor.
- Application: UD CWB5E transmission
- 此工具設計於拆卸 UD 的變速箱，讓維修過程更省時省力
- 適用車種：UD CWB5E 變速箱



H.C.B-A1932

NEW

FUSO (EURO 5) TRUCK FUEL PIPE REMOVAL TOOL

FUSO (EURO 5) 卡車燃油管拆卸工具

- Use for removing diesel fuel pipe connector.
- Application: FUSO EURO 5 (4P10)
- FUSO OEM no.ref.: MH064211.
- 用於拆卸柴油管接頭。
- 適用車種：FUSO 五期環保 (4P10)
- 原廠號碼：MH064211.



H.C.B-A1933

NEW

FUSO (EURO 5) TRUCK CLUTCH SEAL INSTALLATION TOOL

FUSO (EURO 5) 卡車離合器油封安裝工具

- This tool is designed for installing the clutch case seal.
- Application: FUSO EURO 5 lift cars.
- FUSO OEM no.ref.: MH064257.
- 此工具設計用於安裝離合器油封，可快速安裝油封到定位
- 適用車種：FUSO EURO 5 lift cars.
- 原廠號碼：MH064257.



H.C.B-A1934

NEW

ISUZU RT50 TRUCK TRANSMISSION
SPINDLE REMOVAL TOOL KIT

ISUZU RT50 TRUCK 變速箱主軸拆卸工具組

- Use for removing the spindle's 41/46mm x 6PT screw nut and the rear bearing on the main shaft.
- Application: ISUZU RT50 (pickup truck)
- ISUZU OEM no.ref.: 5-8840-2156-0, 5-8840-2027-0, 5-8840-2158-0

- 此工具用於拆卸 41/ 46mm x6 角螺母和主軸上的後培林
- 適用車種 : ISUZU RT50 (皮卡卡車)
- 原廠號碼 : 5-8840-2156-0, 5-8840-2027-0, 5-8840-2158-0

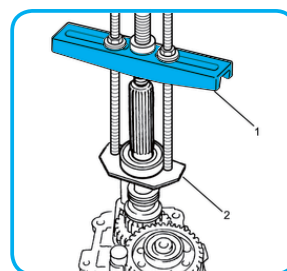

H.C.B-A1964

NEW

ISUZU / JACKAROO INJECTOR SLEEVE
REMOVER (4JX1/4XJ1)

ISUZU / JACKAROO 噴油嘴銅套拆卸器 (4JX1 / 4XJ1)

- Designed for removing stuck injector sleeves. This is a common problem on 4JX1 engines - and this tool provides an easy solution.
- Application: ISUZU / JACKAROO vehicles fitted with a 4JX1 / 4XJ1 engine.

- 設計用於拆卸日系卡車噴油嘴銅套。
- 適用車種 : 配有 4JX1 / 4XJ1 引擎的 ISUZU / JACKAROO





SINCE 1990

HWANG CHERNG BIN
Specialty Tools Inc.

通用卡車修護工具

GENERAL TRUCK REPAIR TOOL



H.C.B-A1102

TRUCK BALL JOINT REMOVER (39 mm) PAT. M 362085

卡車球接頭拔卸器 (39 mm)

10 / 24 / 26.5 / 1'

- On car maintenance.
- The best tool for removing truck ball joint.
- Won't damage ball joint and related parts.
- Easy to use. Save time and money.
- Specification: nut width 26 mm, bolt length 128 mm
- Application: over 4 tons truck, and most of trucks, for example SCANIA, BENZ, MAN, HINO...etc.
- 免拆零件、可車上維修。
- 拆卸球接頭的利器。
- 不會損壞球接頭及相關零件。
- 操作簡便。省時又省錢。
- 規格：螺帽寬 -26 mm · 螺桿長 -128 mm
- 適用車種：4 噸以上的卡車。例如：SCANIA · BENZ · MAN · HINO... 等。

Technical information

- Thoroughly lubricate the bolt, with the grease.
- Use the low RPM to rotate, tighten the bolt while using the air wrench at beginning.
- Use a hammer to hit the central screw on the tool in order to separate the ball joint.

使用方式：

- 使用前請先潤滑中心螺絲。
- 使用氣動扳手旋緊中心螺絲時，一開始請用低轉速。
- 可用錘子敲打中心螺絲，以將球接頭從零件中取下。



Special design Ball Screw
特殊設計鋼珠螺絲



H.C.B-A1407

UNIVERSAL TRUCK BALL JOINT REMOVER (32 mm)

萬用球接頭拔卸器 (32 mm)

- To remove the ball joint of tie rods.
- On car maintenance.
- Best tool for removing truck ball joint.
- Won't damage ball joint and related parts.
- Easy to use. Save time and money.
- Application : Japanese trucks under 10.5 TONS such as HINO、UD、ISUZU and FUSO, especially works great on HINO 500.
- 可用來移除橫拉桿、直拉桿的球接頭。
- 免拆除零件，可車上維修。
- 不會損壞球接頭及相關零件。
- 操作簡易、省時、省力又省錢。
- 適用車種：10.5 噸以下的日系卡車。
- 例如：HINO、UD、ISUZU 和 FUSO，且特別適用於 HINO 500 的卡車



HINO 500





H.C.B-A1112

MEDIUM-SIZED WAGON BALL JOINT EXTRACTOR (32 mm) PAT.

中型貨車球接頭拔卸器 (32 mm)

10 / 26.8 / 29 / 1'

- Application: 3.5~8.8 tons truck
- 適用車種：3.5~8.8 噸卡車



Application: 3.5 tons ~ 8.8 tons trucks

H.C.B-A1165

PICKUP TRUCK & BUS BALL JOINT EXTRACTOR (30 mm)

小型卡車、遊覽車球頭拔卸器 (30 mm)

20 / 21 / 22 / 1.48'

- For removing the tie rod end from the drag link.
- On car maintenance.
- The best tool for removing light truck ball joint.
- Easy to use. Save time and money.
- Application: All light trucks. Such as BMW(E39), Benz(W203/W210/W211/W220/W221), Mitsubishi Delica, Canter, Toyota Dyna.
- 可用來移除方向機橫拉桿上的球接頭。
- 免拆零件、可車上維修。
- 拆卸小型卡車球接頭的利器。
- 操作簡便。省時又省錢。
- 適用車種：所有小型的卡車。例如：BMW(E39), Benz (W203/W210/W211/W220/W221), Mitsubishi Dalica, Canter, Toyota Dyna

screw size:
22Tr x P3.0



TOYOTA DYNA

Technical information

- Make sure the dimension or specification of ball joint match before installing.
- Tighten the bolt by wrench. Hitting the central screw on the tool in order to separate the ball joint.

使用方式：

- 連結球接頭拔卸器前，請先確認球接頭的尺寸或規格相符。
- 請用扳手鎖緊螺絲，再用鎚子敲打中心螺絲，以將球接頭從零件中取下。

H.C.B-A1009

AUTOMATIC TRANSMISSION CLUTCH SPRING COMPRESSOR

自動變速箱離合器壓板拆裝工具

- For removing and installing the transmission rear clutch piston snap ring.
- This tool is adjustable and suitable for most of American cars and light trucks.



- 可移除和安裝後離合器活塞環。
- 可調整式的設計，適用於大部分的美系車輛及輕型卡車。

H.C.B-A1082-1

UNIVERSAL BALL JOINT SEPARATOR (SCREW REPLACEABLE) (24 mm) PAT. 208928

萬用球接頭拔卸組 (可替換螺絲) (24 mm)

30 / 24.2 / 25.7 / 1.18'

- Splitting the ball joint from track-rod ends and anti-roll bar ...etc. Especially in confined space.
- Application: AUDI, VW, BMW, Ford, MERCEDES-BENZ (W170/W202/W210/W220), OPEL, VAUXHALL, MITSUBISHI...etc.
- 可拔卸方向機、橫向穩定桿支架球接頭。特別是在狹小的空間中的球接頭。
- 適用車種：AUDI, VW, BMW, Ford, MERCEDES-BENZ (W170/W202/W210/W2200), OPEL, VAUXHALL, MITSUBISHI 等。



H.C.B-B1182

UNIVERSAL TRUCK BALL JOINT PULLER (REPLACEABLE) (24mm & 32mm) - IMPROVEMENT PAT. M 384746

萬用卡車可換式球接頭拔卸器 (24 mm & 32 mm)- 改良型

- Time and labor saver.
- This an unique replaceable truck ball joint puller. There is the anti-load lubricant stored inside the tool to facilitate the rotating of the screw.
- Application: most truck trucks.
- 經過特殊設計的可換式卡車球接頭拔卸工具。內部儲存耐高壓牛油、以螺桿推動，可達省力及省時的作動方式。
- 適用車種：所有卡車



H.C.B-A1410

UNIVERSAL TRUCK BALL JOINT REMOVER (39 mm) PAT.438423

萬用球接頭拔卸器 (39 mm)

- To remove the ball joint of tie rods, drag links and steering knuckle.
- On car maintenance.
- Best tool for removing truck ball joint.
- Won't damage to ball joint and related parts.
- Easy to use. Save time and money.
- Application: Most of trucks over 15 tons such a SCANIA, VOLVO, DAF, HINO, UD, ISUZU and FUSO.
- 可用來移除橫拉桿、直拉桿的球接頭。
- 免拆除零件，可車上維修。
- 不會損壞球接頭及相關零件。
- 操作簡易、省時、省力又省錢。
- 適用車種：所有 15 噸以上的卡車。
例如：SCANIA, DAF, VOLVO, HINO, UD, ISUZU 和 FUSO

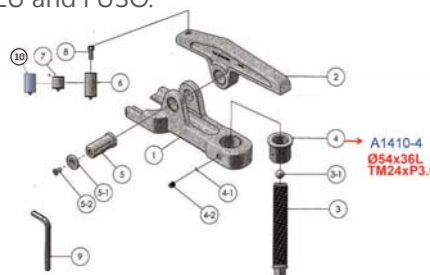

H.C.B-A1410

VIDEO



DAF 42 TONS TRUCK

H.C.B-C1410

UNIVERSAL TRUCK BALL JOINT REMOVER (39 mm) (W/HYDRAULIC SPINDLE) PAT.438423

萬用球接頭拆卸器 (39 mm)(油壓桿)

- It is the best tool to remove the ball joint.
- Application: Most of the truck which is over 15 tons. Example: SCANIA, VOLVO, DAF, MAN, HINO, UD, ISUZU, RENAULT and FUSO
- 拔除球接頭的最佳工具。
- 適用車種：超過 15 噸的大部分卡車，例如：SCANIA、VOLVO、DAF、MAN、HINO、UD、ISUZU、RENAULT 和 FUSO。



VIDEO

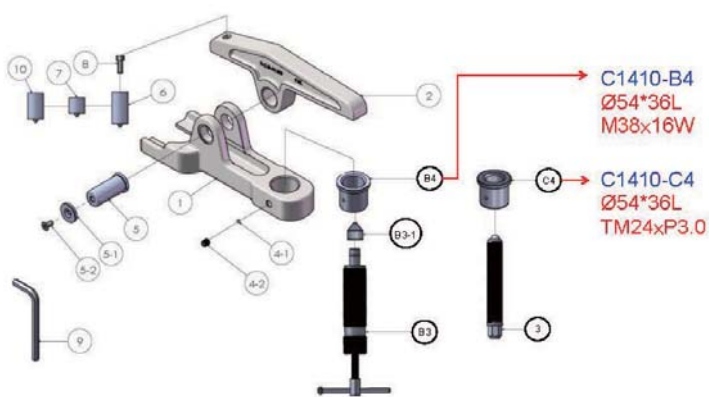

! If hydraulic pressure is over 8 tons, you'll need to use screw.
油壓只能至 8 噸，如超過 8 噸，需使用螺絲。

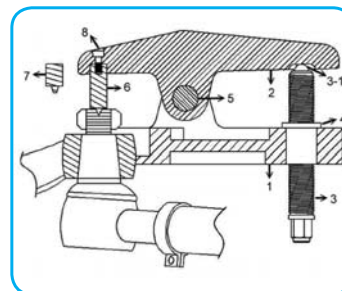

- The tool is used to remove the ball joint of tie rod and drag link.
- Used with low-speed impact wrench.
- With this tool, you can repair on car.
- This tool won't damage the ball joint and related parts.
- Easy to operate and save time and money.
- Material: SCM 440. Made by forged.
- There are two different adaptors that you can choose the appropriate adaptor according to the different ball joint.
- 用來拔除轉向橫拉桿、直拉桿以及轉向座的球接頭工具。
- 搭配低轉速氣動扳手使用。
- 車上維修。
- 此工具較不會傷到球接頭及相關配件。
- 操作容易，省時省力！
- 材質：SCM440 和鍛造。
- 附兩個長短接頭，依據不同的球接頭長度選擇適當接頭配件。

技術資訊 Instructions

- Before using this tool, please remove the safety pin.
- Then loosen the nut, (only loosen instead of taking the nut out), let the nut parallel to the screw. It can prevent the bar from falling and hurt the worker.
- Before using the tool, please lubricate the screw.
- Using the hammer to hit the top of screw to separate the ball joint.
- 使用工具之前，先移除安全銷。
- 之後鬆開螺母（僅鬆開不需整個拿起）與螺桿平行，這樣一來，可以避免拉桿掉落，傷到人員。
- 使用前，螺桿需抹油。
- 使用鐵槌敲打工具上的螺桿頂端，來分開球接頭。

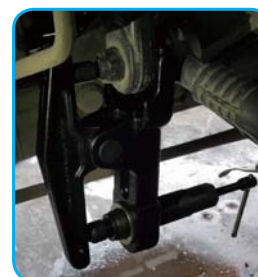

H.C.B-A1225

TRUCK BALL JOINT PULLER (32 mm)(HYDRAULIC)

卡車球頭拆卸器 (32 mm)(油壓式)

- On car maintenance.
- The best tool for removing truck ball joint.
- Won't damage ball joint and related parts.
- Application: 3.5 tons medium-sized wagon~8.8 tons small-sized truck.
- 可在車上維修。
- 拆卸卡車球接頭最佳的工具。
- 不會損壞球接頭和相關零件。
- 適用車種：3.5 噸中型貨車 ~8.8 噸小型卡車。



H.C.B-A1226

TRUCK BALL JOINT PULLER (39 mm)(HYDRAULIC)

卡車球頭拆卸器 (39 mm)(油壓式)

- On car maintenance.
- The best tool for removing truck ball joint.
- Won't damage ball joint and related parts.
- Application: 4 tons truck and most of trucks. For example SCANIA, BENZ, MAN, HINO...etc
- 可在車上維修。
- 拆卸卡車球接頭最佳的工具。
- 不會損壞球接頭和相關零件。
- 適用車種：4 噸和大部份的卡車。例如：SCANIA, BENZ, MAN, HINO... 等。



H.C.B-A1120

TRUCK TRANSMISSION BEARING PULLER

卡車變速箱培林拆卸器

1 / 19.8 / 20.6 / 0.85'



VIDEO



- The best tool for removing truck transmission bearing.
- Won't damage the bearing and related parts.
- Easy to use. Save time and money.
- Application: 4 tons and above truck
#311 can be used on DAF ZF 12S
- 移除卡車變速箱培林的最佳工具。
- 不會損壞培林及相關零件。
- 方便使用，省時又省錢。
- 適用車種：4 噸和以上的卡車
配件 #311 可以使用在 DAF ZF 12 速

Technical information

- Choose the appropriate accessory before operation.
- Press the central screw against the shaft-end by hand when installing the transmission bearing.
- The fixed ring can ensure two sleeves of the tools are securely installed on the groove of the bearing.

使用方式：

- 操作前請選擇合適的配件。
- 安裝培林前，請用手把中心螺絲抵在卡車培林的軸端。
- 固定環可確保工具的套管安置在培林的溝槽上

H.C.B-A1120-308

ISUZU TRUCK TRANSMISSION BEARING PULLER (OPTIONAL ACCESSORY)

ISUZU 卡車變速箱培林拆卸組 (選購配件)

- Combine with H.C.B-A1120
- 搭配 H.C.B-A1120 使用



H.C.B-A1120-309

HINO KUOZUI 15 TONS TRUCK TRANSMISSION BEARING PULLER (OPTIONAL ACCESSORY)

HINO 國瑞 15 噸卡車變速箱培林拆卸組 (選購配件)

- Add H.C.B-A1120-311 on the top of HINO KUOZUI 15 tons truck transmission and H.C.B-A1120-309 on the other end.
- 將 H.C.B-A1120-311 放在 HINO KUOZUI 15 噸卡車的變速箱上，再將 H.C.B-A1120-309 放在另一端。

VIDEO



BEARING



H.C.B-A1120-310

SCANIA TRUCK TRANSMISSION BEARING PULLER (OPTIONAL ACCESSORY)

SCANIA 卡車變速箱培林拆卸組 (選購配件)

- Combine with H.C.B-A1120
- 搭配 H.C.B-A1120 使用

VIDEO



BEARING

H.C.B-A1191

UNIVERSAL BALL JOINT SEPERATOR (22 mm)

萬用球接頭拆裝工具組 (22 mm) (橫拉桿)

- Splitting the ball joint from track-rod and anti-roll bar.etc. Especially in confined space.
- 可拔卸方向機、橫向穩定桿支架球接頭。特別是在狹小的空間中的球接頭。



H.C.B-B1120

TRUCK TRANSMISSION BEARING PULLER

中型貨車變速箱培林拆卸器

H.C.B-B1120-A

FUSO TRUCK LAY SHAFT BEARING PULLER

FUSO 卡車副軸培林拆卸組

H.C.B-B1120-B

ISUZU 6.8 TONS TRUCK MAIN SHAFT BEARING PULLER

ISUZU 卡車 6.8 噸主軸培林拆卸組

H.C.B-B1120-C

ISUZU MEDIUM TRUCK BEARING PULLER

ISUZU 中型卡車培林拆卸組

Features:

- The best tool for removing truck transmission bearing.
- Won't damage the bearing and related parts.
- Easy to use. Save time and money.

Technical information:

- Choose the appropriate accessory before operation.
- Press the central screw against the shaft-end by hand when installing the transmission bearing.
- The fixed ring can ensure two sleeves of the tools are securely installed on the groove of the bearing.
- Application: 3.5 tons-8.5 tons trucks
- B1120-306 (Bearing no.:A6306N) puller:
Used on Fuso main shaft.
- B1120-307 (Bearing no. B6307N) puller:
Used on ISUZU 6.8 tons lay shaft.

Optional:

- B1120-A (Bearing no.:63-28 JNR) puller: Used on FUSO lay shaft
- B1120-B (Bearing no.:6209NR) puller: Used on ISUZU
6.8 Tons Main shaft
- B1120-C (Bearing no.:35TM03NX) puller: Used on ISUZU
Medium trucks

特性:

- 移除卡車培林的最佳工具
- 不會損壞培林及相關零件
- 方便使用 · 省時又省錢

使用方法:

- 操作前請選擇合適的配件
- 拆卸培林前 · 請用手把中心螺絲抵在卡車培林的軸端
- 固定環可確保工具的套管安置在培林的溝槽上
- 適用車種 : 3.5-8.5 噸的中小貨卡
- 306(培林編號 A6306N) 適用於 FUSO 主軸
- 307(培林編號 B6307N) 適用於 ISUZU 6.8 噸副軸

選購配件:

- B1120-A(培林編號 63-28J NR) 適用於 FUSO 副軸
- B1120-B(培林編號 6209 NR) 適用於 ISUZU 6.8 噸主軸
- B1120-C(培林編號 35TM03NX) 適用於 ISUZU 中型車



選購配件 : A.B.C

Optional puller: A.B.C



Bearing



6307N 6306N



H.C.B-A1187

PNEUMATIC BRAKE LINING SHOE LOADER

卡車剎車來令拆裝機 (氣壓式)

- Maximum Capacity : 600 kg/cm²
- Maximum PSI : 8500
- Protect the brake shoe steel.
- This machine is actuated by pneumatic power which is quick and easy to use.
- To fasten and secure firmly than using the riveter.

- 使用時可避免煞車蹄鋼片受損，此機器以氣壓動作，方便快速，較傳統鉚釘機安全，工具多種尺寸可供選擇。

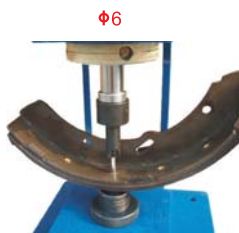
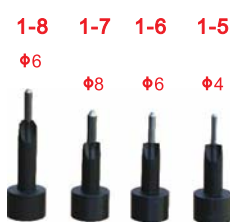

VIDEO



H.C.B-C1181

TRUCK SPRING PIN METAL BUSH REMOVAL/INSTALLATION TOOL KIT (HYDRAULIC)

卡車彈簧銅套 / 插銷拆裝工具組 (油壓式)

- Component No. 4~7, 9~11 is applicable to SCANIA & VOLVO trucks.
- Component No. B4, B6~B14 is applicable to ISUZU, FUSO, TOYOTA Medium-Sized Wagon & Pickup.
- To replace spring pin more easily. Money and labor saver.
- Optional accessory: H.C.B-B1129 HYDRAULIC HAND PUMP.

- 配件 4~7, 9~11 適用於 SCANIA 和 VOLVO 卡車。
- 配件 B4 · B6~B14 適用於 ISUZU · FUSO · TOYOTA 中型貨車及卡車。
- 可輕鬆地更換彈簧銷，省錢又省力。
- 選購配備：H.C.B-B1129 手搖幫浦



VIDEO



H.C.B-D1181

TRUCK SPRING PIN METAL BUSH REMOVAL/INSTALLATION TOOL KIT (17 TONS HYDRAULIC CYLINDER)

卡車彈簧銷拆裝工具組 (17 噸油壓式)

- Money and labor saver.
- Powerful 17 tons hydraulic cylinder helps to remove stubborn spring pins easily.
- 操作省錢又省力。
- 使用強力的 17 噸油壓缸，可輕易地移除卡住的彈簧銷。

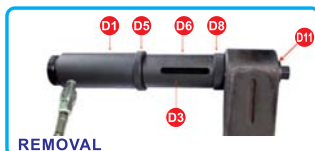

VIDEO



OPTIONAL FOR VOLVO FM12
(選購:VOLVO FM12)

H.C.B-E1181

TRUCK SPRING PIN METAL BUSH REMOVAL/ INSTALLATION TOOL KIT USA PAT.

卡車彈簧銷拆裝工具組



■ Features:

Due to the fact that most of European truck manufacturers design special spring eye bush to prevent the bush from loosening, it results in the difficulty to repair or replacement if without special tools. We create this master kit to solve your problem. Save your time, labor and money!

- Application: VOLVO (FM12),
RENAULT (430/450/460),
MAN-TGA (410/414/460)
DAF (LF/CF)

■ 說明：

因現在歐系各大車廠，所設計的卡車彈簧銷鐵套都是有開口的防鬆鐵套，拆除安裝不易所以更需要此工具組，省時、方便、有效率。

■ 適用車種：

VOLVO (FM12),
RENAULT(430/450/460),
MAN-TGA(410/414/460)
DAF (LF/CF)



VIDEO



Optional(選購)
E1181-20-24 For DAF (CF 85)
truck lift axle lug pin.

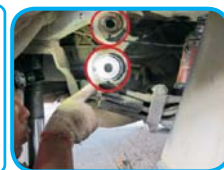

H.C.B-F1181

TRUCK SPRING PIN METAL BUSH REMOVAL / INSTALLATION TOOL KIT (17 TONS HYDRAULIC CYLINDER)

卡車彈簧銷拆裝工具組 (17 噸油壓式)

VIDEO



- Powerful 17 tons hydraulic cylinder helps to remove the stuck spring pins easily.
- The hydraulic cylinder in this kit has a special non-threaded design which makes the operation easier because the screw can be quickly turned in and fixed on the cylinder



- 使用強力的 17 噸油壓缸，可輕易地移除卡住的彈簧銷。
- 與 D1181 不同的是，這組所搭配的油壓缸內為無牙特殊設計，在操作的過程，可以快速的將螺絲轉入固定，使用上更迅速、輕鬆。



Optional(選購)
F1181-F5,F6,F7
For Isuzu FSR 650 (Euro 5)



Caution: To avoid danger, DO NOT stand behind the hydraulic cylinder while operating.

注意：操作過程中，使用者請勿站在油壓缸後面，避免發生危險。



Removal



Installation

H.C.B-A1183

TRUCK THREAD CORRECTOR

卡車可換式螺紋修正器

4 / 25 / 26 / 0.69'

European: SCANIA front wheel
BPW trailer 16 tons >M60 x P2.0

Renault 10 wheels trail (P370) drive axle >M85 x P2.0
Japanese: FUSO, HINO, NISSAN, ISUZU rear wheel
European: SCANIA rear wheel

Optional: (以下為選購配件)

- (1) ROR trailer M65 x P1.5
- (2) YORK TRAILER 2 1/2 x 16 UNC
- (3) BPW trailer 12 tons >M52 x P2.0
UD over 10.5 tons front wheel
- (4) FUSO M91-M95 x P2.0
- (5) HINO over 15 tons & trailer front wheel
UD under 10.5 tons front wheel } >M40 x P1.5
FUSO 8.8 tons & 10.5 tons front wheel
MAN 410/414 front wheel
- (6) FUSO 15/20 tons & trailer front wheel M48 x P1.5
- (7) VOLVO FL10 front wheel M52 x P1.5
- (8) KW truck rear axle (UNC 3 1/4 x 12 W)
- (9) ROR trailer axle (UNC 2 5/8 x 16 W)
- (10) BENZ 2640 (M80 x P1.5)
- (11) BENZ 2640 (EXTRA)(M100 x P1.5)
- (12) FUSO, HINO (10.5 tons) rear wheel (M65 x P2.0)
- (13) DAF(CF85) rear drive axle (M86~M90 x P2.0)
- (14) DAF(CF85) front wheel (M66~M70 x P1.5)
- (15) DAF(CF85) front wheel (M56~M60 x P1.5)
- (16) ROR disc brake 3 1/2" x 12 UNC
- (17) BENZ 120 tons crane / Demag crane (M75 x P2.0)
- (18) SITRAK (M85 x P1.5)
- (19) DAF (CF85) FRONT WHEEL(M58 x P1.5)
- (20) DAF (CF85)(M70 x P1.5)
- (21) BPW ECO FRONT WHEEL(M42 x P2.0)

Warning :

Clean the trailer axle before operating.

After lubricating the axle, then correct the thread from inside to outside

注意：使用工具前必須先清洗輪軸，上機油後由內向外使用

VIDEO

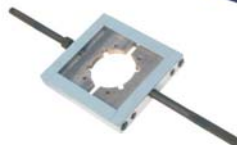

Material (材質) : SKD11
Hardness (硬度) : HRC60~62



H.C.B-A1895

NEW

TRUCK THREAD CORRECTOR

卡車可換式螺紋修正器



WARNING:

1. To clean the trailer axle before operating.

Then correct the thread from inside to outside

2. Please don't over tight the corrector.

Correct the thread for several times and gently.

- Choose the proper thread corrector to modify the thread which makes the nut screws in easier.
- Size: M100xP1.5

請注意：

1. 使用前清潔車軸。並從內到外校正螺牙
2. 請不要擰緊校正器。請多次並輕輕地修正螺紋。
 - 選擇合適的螺紋修正器來修改螺紋，使螺母更容易轉入。
 - 尺寸：M100xP1.5



H.C.B-A1665

UNIVERSAL HYDRAULIC PRESSURE KIT

通用油壓組

- With easy spring reset.
- Hydraulic cylinder with thread and protective cap (3/8NPT thread)
- Operating pressure: 700 bar
- Stroke length: 45 mm
- Outer diameter: 80 mm
- Hydraulic cylinder: 17.5 tons.
- 可輕鬆安裝彈簧插銷
- 接頭: 3/8"
- 壓力: 700 bar
- 行程: 45 mm
- 外徑: 80 mm
- 油壓缸: 17.5 噸



H.C.B-A1690

UNIVERSAL TRUCK BUSH REPLACEMENT TOOL KIT
(W/18 TONS HYDRAULIC)

萬用卡車鐵套更換工具組 (18 噸油壓缸)

- H.C.B-A1690 is a time saving tool for bushings, axles, bearings replacement. It makes bushings, axles, bearings replacement far faster than old-fashion way, and more importantly it saves labor.
- Using H.C.B-A1690 18 ton capacity hollow bore cylinder and the comprehensive set of accessories contained within the kits the equipment can be easily used on any vehicle.
- Applications:
H.C.B-A1690 is used for a wide variety of applications on trucks and buses. It is suitable for brands like Scania, Volvo, MAN, Mercedes, Renault, Iveco and DAF.
- H.C.B-A1690 contains:(包含)
Cylinder(油壓缸): H.C.B-A1690-15-2 (Capacity: 18 tons, stroke: 50 mm)



Sleeve (鐵套):

H.C.B-A1690 -1 (Ø90*73*117 L mm)

H.C.B-A1690 -2 (Ø64*49*117 L mm)

Rod (螺桿):

H.C.B-A1690-3 (M16*P2.0*500L)

H.C.B-A1690-4 (M20*P2.5*500L)

H.C.B-A1690-5 (M24*P3.0*500L)

Press plates(拆裝塊):

H.C.B-A1690-09 (Ø35 mm / Ø16 mm / 22 L mm)

H.C.B-A1690-10 (Ø55 mm / Ø20 mm / 22 L mm)

H.C.B-A1690-11 (Ø70 mm / Ø24 mm / 24 L mm)

H.C.B-A1690-12 (Ø45 mm / Ø16 mm / 22 L mm)

H.C.B-A1690-13 (Ø65 mm / Ø20 mm / 24 L mm)

H.C.B-A1690-14 (Ø90/80 mm / Ø45 mm / 30 L mm)

- 使用 H.C.B-A1690 工具，讓更換鐵套、輪軸、培林更快速。維修工作變的比以前的更換方法更快速。
- 使用 H.C.B-A1690 的 18 噸中空油壓缸，搭配齊全尺寸的配件，可以使用在各種車輛上。
- 適用車種：
H.C.B-A1690 可用在廣泛的卡車和巴士上。例如：Scania, Volvo, MAN, Mercedes 卡車, Renault, Iveco 與 DAF。

H.C.B-A1256

PITMAN ARM PULLER (32 mm)

大車橫拉桿球頭拆卸器 (32 mm)

- Suitable for alloy steel forged tie rod of heavy duty truck.
- Can remove tie rod ends and pitman arm.
- Opening size: 32 mm
- Pull travel: 64 mm
- 適用於重型卡車合金鑄造的橫拉桿。
- 可除移橫拉桿球接頭和方向機搖臂。
- 開口尺寸: 32 mm
- 拔出距離: 64 mm



H.C.B-A1222

UNIVERSAL CRANKSHAFT PULLEY EXTRACTOR

萬用卡車曲軸皮帶盤拆卸器

- For removing the pulley of trucks and installing new crank oil seal.
- This tool helps to take apart the rusted drive shaft and remove the hub.
- Application: Most of Japanese and European trucks. Such as HINO 20 tons, old and new 35 tons, SCANIA, Benz and VOLVO...etc.

- 可用於移除卡車曲軸皮帶盤，且安裝新的油封。
- 本工具可用來拆開生鏽的傳動軸，取出車殼。
- 適用車種：大部份的日系和歐系卡車。
例如：HINO 20 噸，新、舊款 35 噸，SCANIA，BENZ 和 VOLVO... 等卡車。

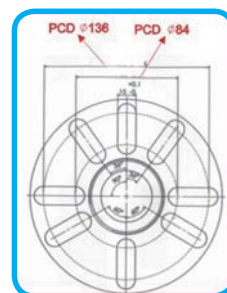

H.C.B-A1279

UNIVERSAL AXLE NUT REMOVAL/INSTALLATION TOOL KIT

萬用型輪軸螺帽拆裝組

- To loosen and tighten the rear wheel nut.
- Pins on both sides are adjustable.
- Aim central hole at the center of hub and then use with wrench.
- Different sizes of pins are suitable for different kinds of truck.
- Application: over 2 tons vehicles with circular nuts.

- 可用來鬆開及鎖緊後輪軸螺帽。
- 雙邊的銷都可以調整。
- 將中心孔對準輪軸中心，再配合扳手使用。
- 不同尺寸的銷可用於不同的車系。
- 適用車種：2 噸以上圓形螺帽的車輛

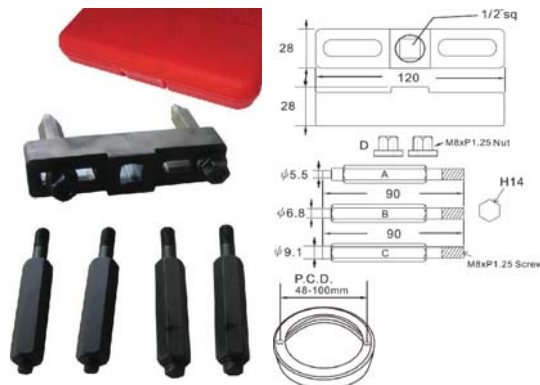

NO	Part Name	Size(Mm)	Qty
A	Pin (for pin-hole)	$\phi 5.5$	2
B	Pin (for pin-hole)	$\phi 6.8$	2
C	Pin (for pin-hole)	$\phi 9.1$	2
D	Nut	M8xP1.25	2
E	Main Body	L:120* W:28 Dr. 1/2"	1

Using:
*Loosening/Tightening of the rear housing nuts.
Application:
*used in small vehicle(over 2 tons)(For Circular Nuts)
Function:
*Both sides can be adjusted
Easy to center as a scale is marked on the wrench.
*With different size pin, the function can be various.



H.C.B-B1391

UNIVERSAL TRUCK WHEEL HUB EXTRACTOR

萬用卡車輪軸 HUB 拆卸器

- The bolts of this extractor are ranged from 110 mm P.C.D to 448 mm P.C.D.
- Master wheel hub extractor for Japanese trucks (Fuso, Hino...) and European trucks such as SCANIA, Sauer & BPW. UD (26 Ton)
- Save time and labor!
※ 使用前請放開手煞車
- 本體的螺桿距離可從 110 mm P.C.D. 到 448 mm P.C.D.
- 萬用的卡車輪軸 HUB 拆卸器可用於日系卡車及歐系卡車 (例如: SCANIA, Sauer 和 BPW)
- 省時省力! 是您最佳利器!
- B1391-10 can use on M18 M20 M22 and 7/8"
- B1391-11 can use on M24 and M30

VIDEO

OPTIONAL: 10, 11
(選購)

Item No. / 編號	Name/ 品名	Specification / 規格	Q'ty/ 數量
B1391-A	Body / 本體	L500 mm x H49 mm x W60 mm	1
B1391-A-1	Set Bolt / 螺絲	M8 x P1.25	1
B1391-B	Nut / 螺帽	TM30 x 6 Thread	1
B1391-C	Bolt / 螺桿	TM30 x 6 Thread x 350 mm/L	1
B1391-C-1	Steel Ball / 鋼珠	Ø17.5 mm	1
B1391-C-2	Central Tip / 中心尖頭	Ø23 x 35.8 mm/L	1
B1391-D	Bolt / 螺桿	M22 x P2.5 & M22 x P1.5 x 340 mm/L	2
B1391-E	Nut / 螺帽	M22 x P2.5(H36)	4

Item No. / 編號	Name/ 品名	Specification / 規格	Q'ty/ 數量
B1391-1	Thread Adaptor / 螺帽	M18 x P1.5 x 65 mm/L	2
B1391-2	Thread Adaptor / 螺帽	M20 x P1.5 x 65 mm/L	2
B1391-3	Thread Adaptor / 螺帽	M22 x P1.5 x 65 mm/L	2
B1391-4	Thread Adaptor / 螺帽	M24 x P1.5 x 65 mm/L	2
B1391-5	Thread Adaptor / 螺帽	M30 x P1.5 x 65 mm/L	2
B1391-6	Pressure Plate - Small / 小墊塊	DØ90mm x d65mm x T40mm	1
B1391-7	Pressure Plate - Large / 大墊塊	DØ110mm x d85mm x T40mm	1
B1391-8	Thread Adaptor / 螺帽	7/8"-W11	2
B1391-9	Pressure Plate / 墊塊	DØ90 mm x dØ62.7 x T30 mm	1

H.C.B-C1391

UNIVERSAL TRUCK WHEEL HUB EXTRACTOR

萬用卡車輪軸 HUB 拆卸器

- Variable bolts is suitable for diameter from 110 mm P.C.D to 448 mm P.C.D.
- Master wheel hub extractor for Japanese trucks (Fuso, Hino...) and European trucks such as SCANIA & Sauer & BPW.
- Save time and labor!
- 多樣性的螺桿 . 可適用 P.C.D 110 mm 到 448 mm.
- 可用在日系卡車 (FUSO, HINO...) 和歐系卡車上 (SCANIA, SAUER, BPW)
- 省時省力! 是您最佳利器!



H.C.B-A1383

ELECTRICAL BRAKE LINING SHOE LOADER PAT.409117

電動鉚釘機

- Maximum capacity: 2.7 tons
- Maximum pressure: 140 kg/cm²
- Motor: 0.75KW
- Voltage: 220V/ 1HP/ 60Hz
- Stroke: 100 mm

- 最大出力：2.7 噸
- 最高使用壓力：140kg/cm²
- 馬達：0.75KW
- 電壓：220V/ 1HP/ 60Hz
- 行程：100 mm



VIDEO



H.C.B-A1054-2

UNIVERSAL SEPARATOR (R2) PAT. 172921

萬用拔卸器 (R2)

12 / 17.7 / 20.5 / 1.05'

- Multi-purpose puller set for balancer, pulley & gear.
- Application: FORD, TOYOTA, LEXUS GS 300 (1999~2004)
- 可用於平衡桿、皮帶盤和齒輪拔卸
- 適用車種：FORD, TOYOTA, LEXUS GS 300 (1999~2004)



H.C.B-A1054-2 on LEXUS GS300 (1999-2004)

H.C.B-A1054-4

STEERING WHEEL PULLER BOLT (EXTENDED)

方向盤拔卸器螺絲 (加長型)



H.C.B-A1287

DAEWOO TRUCK WHEEL AXLE NUT SOCKET (Dr. 3/4", 6 POINTS, 116 mm)

大宇卡車輪軸螺帽套筒 (Dr. 3/4", 6 角, 116 mm)

- To remove/ replace the wheel axle nut of DAEWOO.
- Size: Dr. 3/4", 6 points, 116 mm.
- 可移除 / 更換大宇卡車的輪軸螺帽。
- 尺寸: Dr. 3/4" · 6 角 · 116mm



H.C.B-A2018-27**HYUNDAI PORTER / KIA MOTOR TRUCK OIL FILTER WRENCH
(Dr. 1/2", 15 POINTS, 91.7 mm)**

HYUNDAI PORTER / KIA MOTOR 卡車機油芯扳手
(Dr. 1/2", 15 角, 91.7 mm)

- Oil filter genuine no. : 26300-42040、26300-42030、26300-42060
- Application: HYUNDAI PORTER TRUCK、KIA Motors
- Size: Dr. 1/2", 15 Points, 91.7 mm
- 機油芯料號: 26300-42040、26300-42030、26300-42060
- 適用車種: HYUNDAI PORTER TRUCK KIA Motors
- 尺寸: Dr. 1/2", 15 角, 91.7 mm



Dr. 1/2"

**H.C.B-A2013****TRANSMISSION FLOOR JACK (1 TON)**

臥式變速箱千斤頂 (1 噸)

1 / 60 / 63.8 / 3.81'

- Designed ideally for removal and installation of automobile and light truck transmission or differential.
- Universal saddle, brackets and chain sling are fully adjustable to accommodate transmission, clutches and differential in varying size.
- Safety overload system and safety by-pass system prevent from damaging cylinder.
- Flash chromed ram inhibits rust from entering the hydraulic system.
- Four swivel caster wheels allow for easy positioning.
- Low frame passes undercarriage obstacles easily.
- Sensitive release valve helps to load lower.
- 是用來移除和安裝汽車及輕型卡車的變速箱或差速器的理想工具。
- 萬用的托架、支撐座和吊鏈可調整，用於各種尺寸的變速箱、離合器和差速器。
- 低底座可輕易地通過汽車底盤下的障礙物。
- 感應式洩壓閥可讓載重後的千斤頂放得更低。
- 防超載、防傾倒系統，可避免損壞油壓缸。
- 亮面的鍍鉻油壓缸，可以預防夾帶灰塵進入油壓系統中。
- 四個可轉動的腳輪，方便推動。

**H.C.B-A2101****UNIVERSAL ADJUSTABLE WHEEL BEARING LOCK NUT WRENCH**

後軸螺帽拆卸器 (萬用型) **10 / 25 / 26 / 1.71'**

- Adjustable jaws to fit all hexagon & octagon wheel bearing lock nuts.
- Contains three sets of pins, is applicable to any size nut.
- Specification:
6PT lock nuts: 1-3/4" to 5-3/4" (49~135 mm)
8PT lock nuts: 1-3/4" to 5-5/9" (49~143 mm)
Pin diameters: 1/4" (6 mm), 5/16" (8 mm) and 3/8" (10 mm)
- 可調整式拔取爪可適用於所有六角和八角的輪軸培林固定螺帽。
- 本組工具配備有三組插銷，可適用於任何尺寸螺帽。
- 規格：
6角固定螺帽：1-3/4" to 5-3/4" (49~135 mm)
6角固定螺帽：1-3/4" to 5-5/9" (49~143 mm)
插銷尺寸：1/4"(6 mm), 5/16" (8 mm) and 3/8"(10 mm)



H.C.B-F1168

UNIVERSAL BALL JOINT SERVICE KIT PAT M.333280

專利型萬象十字接頭拔卸器

- Special design for bolt, if the bolt is broken and you only need to replace the bolt of c-clamp, don't need to change the whole c-clamp set.
- The C-clamp was forged, its material is SCM440 and hardness is HRC 38°-42°
- On car maintenance
- It contains heavy-duty C frame press, receiver tubes, and adapters that both install and remove pins.
- This tool set is designed for using on most cars and light trucks that have press-fit type ball joints. It will help the user remove and install ball joints without the need to remove the control arm from the vehicle.

NOTE: Some cars and light trucks may have the upper ball joint spot-welded to the control arm. The weld must be cut before attempting to remove the ball joint.

- C型內有特殊設計，當螺絲斷裂，只需更換螺絲，而不需更換整個C型。
- 此C型為鍛造，材質是SCM440，硬度為HRC 38°-42°
- 可在車上直接做維修動作
- 此工具包含C型，和拆卸/安裝管
- 此工具組設計可使用在大部分的小車和輕型卡車。不用將控制臂從引擎拆下，技師就可直接拆卸/安裝球接頭。

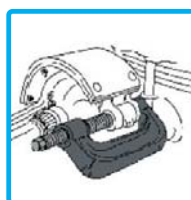

Brake Anchor Pin
Extraction and Installation

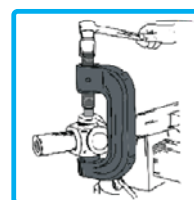

"U" Joint Extracrgion
and Installation

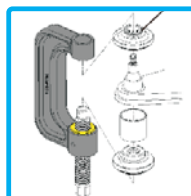

Removal

Patented design O-ring can be fixed in top, toprevent the tool from falling

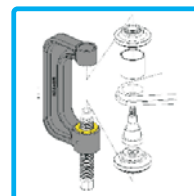

Installation

Patented design O-ring can be fixed in top, toprevent the tool from falling

H.C.B-A1850

NEW

HEAVY DUTY U-JOINT PULLER

卡車 U 形球頭拔卸器

NOTE: hammering this tool will void your warranty.

- 1.Remove all fasteners from bearing cups.
- 2.Slip the U-Joint Puller over the yoke of the drive line.
- 3.Turn the tool's forcing screw clockwise with up to a 1" impact wrench.

- Application
U-Joints with bearing cups 1.5"to 2.2" O.D.
Spicer 1610, 1710, 1760, 1810, 1880 Series
Spicer SPL 140, 170, & 250 Life Series
Meritor (Rockwell) 16N, 17N, 18N, 1710 Series
Meritor RPL 20, 25 Permalube Series

注意：若槌擊此工具即不再擁有產品保固

- 1 將零件從培林上拆下
- 2.U 型接頭套上零件
3. 使用 1" 衝擊扳手順時針旋轉

- 適用車種：
搭配培林尺寸為 1.5" to 2.2" O.D 的球接頭
Spicer 1610, 1710, 1760, 1810, 1880 系列
Spicer SPL 140, 170, & 250 Life 系列
Meritor (Rockwell) 16N, 17N, 18N, 1710 系列
Meritor RPL 20, 25 Permalube 系列



H.C.B-A2019

3 TONS FOUR WHEELS HYDRAULIC FLOOR JACK

3 噸油壓四輪千斤頂

1 / 69 / 74 / 4.9'

■ Features:

1. Ideally suitable for all automotive, agriculture and light truck repair facilities.
2. Mobile "T" handle and two mobile foot pedals can speed up for loading.
3. "T" handle can be locked in the position of the three specific angles to lower load and easy maneuvering.
4. Extra long chassis can reach any position under the vehicle.
5. Hydraulic power unit with dust seals to prevent oil contamination.
6. Large and heavy-duty hear swivel caster wheels to provide easy maneuvering and positioning of jack.

■ Capacity: 3 tons

■ 產品特色：

1. 適用於所有的汽車、農機和輕型卡車的維修。
2. 活動式的 T 型把手和兩個活動式踏板，可加速裝載。
3. T 型把手可以固定在三個特殊的角度，用來放低重心、方便移動。
4. 加長的底座可以深入車底。
5. 油壓系統加防塵油封，可預防油污。
6. 大型耐重的旋轉輪，可防止傾倒和定位千斤頂。

■ 載重：3 噸

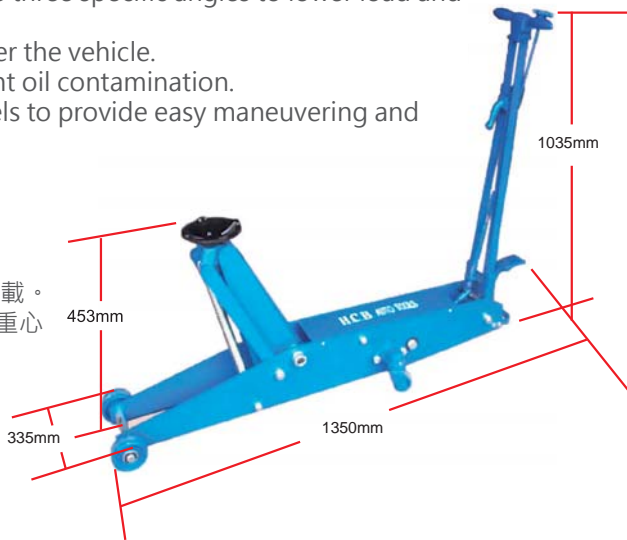

H.C.B-A2045

1.5 TONS TRUCK TRANSMISSION JACK

1.5 噸卡車變速箱千斤頂

1 / 130 / 150 / 10.5'

- The best tool for removing / installing transmission or differential of auto and light trucks.
- This set contains adjustable saddle brackets and chain, and is suitable for to every size of transmission clutches and differential.
- Safe overload and bypass system prevents cylinder from damaging.
- Rust-proof with flashing chromed ram inside the hydraulic system.
- 360° rotary handle. Easy to use.
- Four swivel caster wheels are easy to move under the vehicles.
- Releasing the valve to lower this tool.
- Capacity: 1.5 tons

- 移除和安裝汽車及輕型卡車的變速箱或差速器的絕佳工具。
- 本工具配備有可調式托架、支撐座和吊鏈，可用於各種尺寸的變速箱、離合器和差速器。
- 防超載、防傾倒系統，可避免損壞油壓缸。
- 防塵的亮面鍍鉻油壓缸，可以預防夾帶灰塵進入油壓系統中。
- 四個可轉動的腳輪，方便推動。
- 放開洩壓閥可放低千斤頂。
- 載重：1.5 噸



H.C.B-A2102

HYDRAULIC WHEEL DOLLY

大車輪胎搬運車

- Easy to remove / install / move tires.
- Hydraulic lifting.
- Rolling carriage can assist tire to rotate to the right position.
- Stand firm by four wheels. Also help to lifting steadily.
- Light frame and two swivel casters, make it easy to move.
- Multi-functional tool.
- Maximum capacity of carriage: 52" tire.
- Maximum capacity of hydraulic jack: 2 tons.

- 可拆卸 / 安裝 / 搬運輸胎。
- 油壓式升高裝置。
- 滾動式承載架可協助輪胎轉動至正確位置。
- 四個腳輪可讓搬運車站得更穩、升高時也更穩定。
- 輕量化的本體結構和兩個可旋轉的腳輪，讓移動更方便。
- 多功能的工具。
- 最大承載尺寸：52" 輪胎
- 油壓缸：2 噸

VIDEO



Capacity (KG/LBS)	Lift Range (mm/inch)	Length of Lifting Arms (mm/inch)	Overall Length (mm/inch)	Overall Width (mm/inch)	Overall Height (mm/inch)	Package (W/Case)
500/1200	115-290 4-1/2"~11-2/5"	570 22-2/5"	810 31-9/10"	890 35"	800 31-1/2"	94KG/99KG /17.5'

H.C.B-B2102

HYDRAULIC WHEEL DOLLY

大車輪胎搬運車

Features:

- Equipped with foot-operated hydraulic jack which makes it more convenient to operate when installing wheels.
- Heavy-duty chain can secure the wheels.
- Tubular lifting arms which are adjustable can easily fit and carry the middle and large size tires.
- Rear casters and front wheels help to move this dolly easily with good maneuverability.
- Adjustable rear casters with 3-1/4" travel.
- Foot pedal can be folded up for storage and prevent the risk of injury.
- Capacity: 600 Kg
- N.W.: 120 Kgs, G.W.: 134 Kgs, CUFT.:15.7'

特色：

- 此輪胎搬運車配有腳踏型油壓千斤頂，讓安裝輪胎時可以更方便的操作千斤頂。
- 配有高負重鐵鍊，可以固定輪胎，以防掉落。
- 鋼管型可調式舉升臂可以對應、承載各種中、大型輪胎。
- 後方腳輪及前方固定輪可協助移動、操控此搬運車。
- 可調式後方腳輪，具 3-1/4" 的可調行程。
- 腳踏板可以摺疊以便收納及防止有人碰觸、受傷。
- 最大負重：600 Kg
- 淨重：120 Kgs、毛重：134 Kgs、材積：15.7'



H.C.B-B2115

BLIND HOLE BEARING PULLER

隱蔽型培林拔卸組

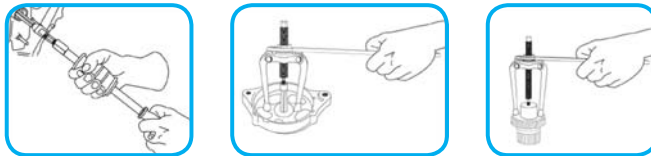

- Applicable to automobiles, motorcycles, and machine repairing. It is convenient and easy to use.
- Both slide hammer-type bearing puller or two-leg universal pullers are capable to remove the bearings.
- It is the best tool used on manual transmission blind hole flywheel bearing. For example: TOYOTA, FORD...etc.
- H.C.B-B2115-9-3 can be used to remove the log pin installed on motorcycles.

REF		RANGE
H.C.B-B2115-1		min A max 8mm-11mm
H.C.B-B2115-2		min A max 12mm-17mm
H.C.B-B2115-3		min A max 18mm-23mm
H.C.B-B2115-4		min A max 24mm-29mm
H.C.B-B2115-5		min A max 30mm-34mm
H.C.B-B2115-10		min A max 34mm-38mm
H.C.B-B2115-11		min A max 39mm-43mm
H.C.B-B2115-12		min A max 44mm-48mm
H.C.B-B2115-13		min A max 49mm-53mm
H.C.B-B2115-14		min A max 54mm-58mm
H.C.B-B2115-9-1		A size M10*1.5P B size
H.C.B-B2115-9-2		A size M10*1.5P B size M8*1.25P
H.C.B-B2115-9-3		A size M10*1.5P B size M6*1.0P

- 適用於汽車、摩托車和機械的維修。方便好操作。
- 包含有滑錘式和兩爪式的培林拔卸器。
- 拔取變速箱飛輪隱蔽型培林的利器。適用車種繁多例如：TOYOTA, FORD... 等。
- H.C.B-B2115-9-3 可以用於維修摩托車。

H.C.B-A1015

BLIND HOLE BEARING PULLER

隱蔽型培林拔卸組

5 / 17.2 / 18 / 1.64'

- One slide hammer assemble & 4 clamps.
- Attachments: ① 3/8" to 1/2"(10-14 mm)
② 9/16" to 11/16"(15-19 mm)
③ 5/8" to 1" (18-25 mm)
④ 1" to 1-1/4"(25-32 mm)
ID bearings' pulling.
- Open clamps by turning handle clockwise to grab the bearing for pulling out evenly without damaging the parts.
- 本組工具包含一支滑錘和四支螺桿拔取爪。
- 螺桿拔取爪尺寸：
1. 3/8"-1/2"(10-14mm)
2. 9/16"-11/16"(15-19mm)
3. 5/8"-1"(18-25 mm)
4. 1"-1-1/4"(25-32 mm)
- 順時針方向轉動手把、張開螺桿拔取爪直到貼合培林的內側，以拔出培林。不會損壞相關零件。

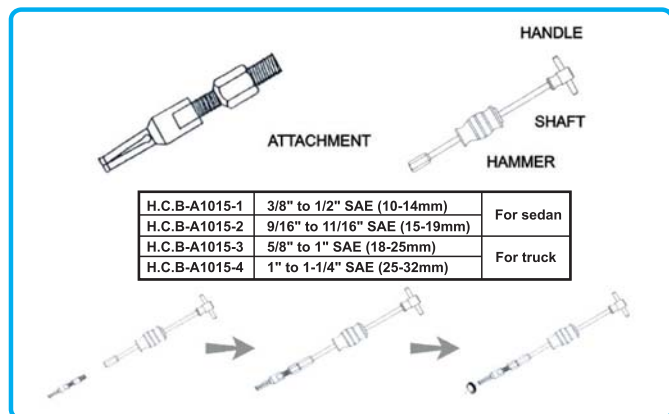

H.C.B-A1435

KENWORTH TRUCK REAR AXLE NUT SOCKET (SW 4", 6 POINTS, Dr. 3/4")

KENWORTH 卡車後輪軸螺帽套筒 (SW 4", 6 角, Dr. 3/4")

- The unique design and profile of the socket make it perfectly match the position and prevent the damage of axle nut.
 - The robust socket is manufactured from a piece of material.
 - It can be used with torque wrench.
 - Size: Dr. 3/4", 6 points, SW 4"
 - Application: KENWORTH Truck
- 獨特輪廓設計的套筒使它與螺母吻合，可輕易拆卸而不傷及零件。
 - 由一整塊材料切割而成的套筒，使它更為堅固及耐用！
 - 可搭配扭力扳手使用！
 - 尺寸：Dr. 3/4" · 6 角 · SW 4"
 - 適用車種：KENWORTH 卡車



KW TRUCK NUT

Dr. 3/4"

H.C.B-B1655

UNIVERSAL BEARING EXTRACTOR

萬用培林拔卸器

- For extracting inner bearings, bearing outer rings and bushings.
 - Mechanical pressure screw.
 - Milled thread treated with special coating.
 - Strong design, high performance and long service life.
 - Safety label to ensure protection of intellectual property.
 - Self-healing corrosion protection for galvanized parts.
- 此拔卸器適用於拔除內部培林、培林外圈環及鐵套。
 - 機械式壓力螺絲。
 - 具特殊塗層螺牙。
 - 完美的設計提供高效能及長久的使用壽命。
 - 拔卸器上貼有安全貼標提供正確的安全知識。
 - 具鍍鎳的零件可防止鏽蝕。



No.								
	mm	inch	mm	inch	mm	inch	segment	kg
B1655-01	6-10	15/64-25/64	14	9/16	73	2 7/8	2	0.112
B1655-02	8-12	5/16-15/32	14	9/16	73	2 7/8	2	0.11
B1655-03	10-14	25/64-9/16	14	9/16	73	2 7/8	2	0.112
B1655-04	12-16	15/32-5/8	25	1	72	2 27/32	2	0.104
B1655-05	14-19	9/16-3/4	27	1 1/16	72	2 27/32	2	0.218
B1655-06	18-23	23/32-29/32	35	1 3/8	89	3 1/2	2	0.22
B1655-07	20-30	25/32-13/16	40	1 9/16	92	3 5/8	2	0.222
B1655-08	28-40	1 7/64-1 9/16	23	29/32	101	3 31/32	2	0.388
B1655-09	35-46	1 3/8-1 13/16	50	1 31/32	113	4 7/16	2	0.666
B1655-10	45-58	1 25/32-2 9/32	85	3 11/32	135	5 5/16	2	1.2

H.C.B-A2165

HYDRAULIC BEARING PULLER (8 TONS)

油壓式培林拔輪器 (8 噸)

H.C.B-B2165

HYDRAULIC BEARING PULLER (8 TONS)

油壓式培林拔輪器 (8 噸)

H.C.B-C2165

HYDRAULIC BEARING PULLER (12 TONS)

油壓式培林拔輪器 (12 噸)

H.C.B-D2165

HYDRAULIC BEARING PULLER (4 TONS)

油壓式培林拔輪器 (4 噸)

H.C.B-E2165

HYDRAULIC BEARING PULLER (12 TONS)

油壓式培林拔輪器 (12 噸)



HYDRAULIC BEARING PULLER
油壓式培林拔輪器

Item No.	CAPACITY	Reach(mm)		Spread(mm)		Stroke(mm)		Pump Tip(mm)			Jaw Tip(mm)				Weight(kg)
		A	B	C	D	H	E	F	G	A	B	C	I		
A2165	8 TONS	270	-	95	220	85	50	25	122	-	-	-	-	14.3	
B2165	8 TONS	229	57	100	350	85	50	25	122	11	10	25	51	8.2	
C2165	12 TONS	381	-	120	290	85	60	28	118	-	-	-	-	18.0	
D2165	4 TONS	250		55	110	60	42	22	84					7.6	
E2165	12 TONS		270		375	85	60	28	118	14	10	29		10.9	

- Four stages of foldable & removable handle saves the labor during operation.
- 360° rotary socket.
- Integrated hydraulic pump which has puller with safety valve.
- Heat treated & chrome plated hydraulic cylinder rod provides stronger pulling force.
- Easily release valve.
- Spring loaded central nut for easy job (replaceable).
- 2/3 jaws combination puller cross head with manganous-phosphate plated for rust proof and durability.
- Heat treated forged alloy steel cross bolts & jaws with manganous-phosphate plated for rust pro of and long life service.
- 四段式的折疊、可移除的手把，讓操作更省力。
- 360°旋轉式套筒。
- 包含一體成型的油壓組和附有安全閥門的拔取器。
- 熱處理鍍鉻油壓桿，提供更強的拔取力。
- 方便操作的閥門。
- 可更換式彈簧支撐中心螺帽，方便操作。
- 鍍磷酸錳的拔取爪，可防塵、更耐用。
- 熱處理鍍磷酸錳螺絲，可防塵、更耐用。



H.C.B-B2126

20 TONS AIR HYDRAULIC BOTTLE JACK

20 噸氣動油壓千斤頂

H.C.B-B2127

30 TONS AIR HYDRAULIC BOTTLE JACK

30 噸氣動油壓千斤頂



H.C.B-B2126



H.C.B-B2127

Product number	Cylinder Capacity (Ton)	Stroke (mm)	Coll. Height A(mm)	Ext. Height B(mm)	Plunger Dia J(mm)	Base Dimensions LxM(mm)	Auxiliary Height (mm)	Weight (kg)	Air pressure Range (Kgf/cm)
H.C.B-B2126	20	106	204	310	55	125x190	17,43,68	12.6	8-12
H.C.B-B2127	30	145	245	390	75	225x150	10,45,80	22.7	8-12

- The carbon steel base by automatic weld makes stable quality.
- The self-return functions of flashing chrome plunger can extend life and resist corrosion
- Design of air pump makes operation highly efficient
- For all model
- 高品質的中碳鋼、焊接底座。
- 鍍鉻亮面、自動收回式油壓桿，可延長使用期、防鏽。
- 可連接氣壓幫浦使用，提高效率。
- 通用型。

H.C.B-A2146

PNEUMATIC GREASE PUMP (20 L)

氣動黃油機 (20 升)



- Pneumatic grease pump uses air as power to suck grease into lubrication points. It is suitable for using with machines, automobiles and vessels...etc. It is a very useful tool for lubrication and maintenance.
- 分離式幫浦，利用壓縮空氣驅動抽取流質液體，幫浦為兩個獨立循環系統，空氣水份不致接觸油質，適用於各種機械、車輛、飛機、輪船等，為保養潤滑時強功注入黃油的利器。

Model 型號	Capacity 容量	Air Input Pressure 容氣輸入壓力	Pressure Ratio 壓力比	Grease Output Pressure 黃油輸出壓力	Deliver Rate 輸出量	Hose Length 油管長度	N.W. 淨重	G.W. 毛重	CUFT 材積
H.C.B-A2146	20L	4~9Kg/cm ²	45:1	180~405Kg/cm ²	30cc/sec	10 ft	20.9Kgs	23.4Kgs	6.2'

H.C.B-A2160

WASTE OIL DRAINER (80L)

廢油桶 (80 升)

- Waste oil mobile reservoirs are used for motor and gear oil collection.
- Drainers can be used under vehicle lifts or inside lubrication pit.
- Large handle for easy maneuverability.
- Two brake wheels (\varnothing 3") and two casters (\varnothing 3")
- Extra large and adjustable drain bowl can collect waste oil conveniently and safely.

- 可用於承接機油箱和齒輪箱的廢油。
- 廢油盤可以放置在堆高機下方或油箱內。
- 加長把手可方便操作。
- 配備有兩個剎車腳輪、兩個轉向腳輪。
- 加大、可調整式的廢油盤，可方便、安全地承接廢油。

■ Specification

Model	H.C.B - A2160
Dimension	470x560x1140~1580mm
Capacity	80 L
Weight	36 kgs
Oil Draining Power	Compressed Air 100~120 PSI Air Pressure



■ Accessory:



Oil Drain Pan / 550 mm



Oil Drain Pan / 530 mm



Collection Bowl / 380 mm



Pre-Spray Net

H.C.B-B2160

WASTE OIL DRAINER (MANUAL) (50 L)

手動升降式停油機 (50 升)

- Composite lid and drum with 50 liters reservoir and drain pan telescopic post
- Gravity drain using tap on rear of unit. Includes visible 'Full Drum' device.
- Includes large diameter drain pan insert and heavy duty mesh for draining oil filters.
- Manual operation
- Dimension: 550x550x900-1070 m/m
- Capacity: 50 L
- Weight: 12 kg

- 配有複合式的蓋子可儲存 50 公升的儲油桶
- 內含大尺寸的排水盤和強大的排水濾油系統
- 手動操作
- 尺寸 :550x 550x 900 mm
- 容量 :50 公升
- 重量 :12KG



H.C.B-A2203

PNEUMATIC FLUID EXTRACTOR (8.5 L)

氣動抽油機 (8.5 升)

4 / 6 / 10 / 3.8'

- Can extract car engine oil. Capacity 8.5 L
- Pneumatic extractor, non-sparking making.
- Only need one person to operate.
- 1 meter silicon hose with universal rubber adapters can fit most of brake.
- Special fixing valve and safety cup are for automatic cut-off extracting.

- 可抽取汽車機油，最大容積 8.5 公升。
- 氣動式抽取，不會產生火花。
- 只需一人即可操作。
- 1 公尺長矽膠管配上萬用橡膠接頭，可用於大部份的車輛。
- 特殊的固定式閥門和安全杯，可自動中斷抽油動作。

ADAPTER (OPTION) :
■ NITTO ■ MILTON ■ ORION



SPECIFICATIONS:

Air inlet	1/4"
Avg. Air cons	2 CFM
Working pressure	40~170 PSI
Temperature range	-19.4°C~60°C
Max. Capacity	8500 c.c.

H.C.B-A2204

PNEUMATIC OIL & LIQUID DISPENSER (6000 c.c.)

吸排兩用液體分裝機 (6000 c.c.)

6 / 16 / 17 / 4.7'

- Equipped with the safety valve helps to stop air pressure automatically when the pressure reaches the pre-setting (43psi (3kg/cm²))
- Provide with pressure gauge makes read and control the air pressure in the tank more easily.
- Application: BENZ 722.9

- 有安全閥可預設自動停止的壓力 (43 psi (3 kg/cm²))。
- 配備有壓力錶，方便讀取和控制桶內的壓力。
- 適用車種：BENZ 722.9

SPECIFICATIONS:

Air inlet	1/4"
Avg. Air cons	2 CFM
Temperature range	-19.4°C~60°C
Max. Capacity	6000 c.c.

ADAPTER (OPTION) :
■ NITTO ■ MILTON ■ ORION



H.C.B-A2205

BASIC BRAKE OIL EXTRACTOR (2000 c.c.)

專業剎車油吸取機 (2000 c.c.)

12 / 15 / 16 / 6'

ADAPTER (OPTION):
■ NITTO ■ MILTON ■ ORION

- Economical-fast and easy, reduces labor costs.
- Versatile-handles most standard and ABS brake system.
- Clean-collects old brake Fluid without spillage.
- Quiet-integrated silencer for a quiet working environment.
- Silicon-suction assemblies with universal rubber fitting.

- 經濟 - 快速、簡便、可節省人力成本
- 用途多 - 可用於大部份標準和 ABS 煞車系統
- 乾淨 - 收集廢油、不用擔心溢漏
- 靜音 - 一體成型式消音器，提供安靜的工作環境
- 配備有矽膠抽取器和萬用橡膠接頭

SPECIFICATIONS:

Air inlet	1/4"
Avg. Air cons	2 CFM
Working pressure	40~170 PSI
Temperature range	-19.4°C~60°C
Max. Capacity	2000 c.c.

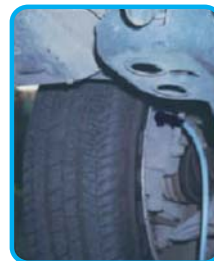

H.C.B-A2206

BRAKE OIL FILLER (1000 c.c.)

剎車油補充油瓶 (1000 c.c.)

12 / 7 / 8 / 1.8'

- To fill brake oil easily.
- Capacity : 1000 c.c.

- 方便灌注剎車油
- 容量 : 1000 c.c.



ADAPTER (OPTION):
■ NITTO ■ MILTON ■ ORION

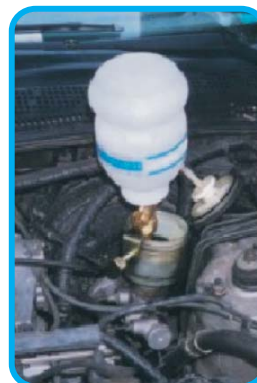
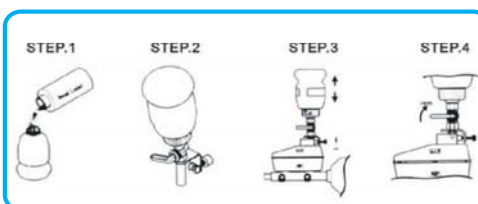



H.C.B-A1065

WAGON SUPPORTER

貨車專用安全頂架 (配合平板頂車機使用)



H.C.B-A2147

GREASE FILLER FOR PAIL (20 L)

鋁合金手壓式培林注油機 (20 升)



放入培林

注油完成



型號 (Model)	H.C.B-A2147
尺寸 (Dimension)	340 x 330 x 570 mm
材質 (Material)	鋁合金 (Aluminium alloy)
重量 (Weight)	8.1 kgs
適用範圍 (Bearing Diameter)	120~170 mm
適用車種 (Application)	中型卡車 (medium truck)

H.C.B-A2148

TRACK BEARING PACKER (FOR TRUCK)

鋁合金氣壓式培林注油機



型號 (Model)	H.C.B-A2148
尺寸 (Dimension)	240 x 240 x 220 mm
材質 (Material)	鋁合金 (Aluminium alloy)
重量 (Weight)	6.8 kgs
適用範圍 (Bearing Diameter)	150~200 mm
直徑 (Ø)	200 mm
適用車種 (Application)	大型卡車 (Freight vehicle)



H.C.B-A2157

TRUCK JACK STAND 15,000 LBS

卡車千斤頂 15,000 磅

- Spring loaded caster for easy positioning and portability.
- 彈簧支撐腳輪可協助定立和移動。

Item	Part No.	Description	Q'ty
1	H.C.B-A2157-1	Main Tube	1
2	H.C.B-A2157-2	Removal Tube	1
3	H.C.B-A2157-3	Leg	3
4	H.C.B-A2157-4	Link	3
5	H.C.B-A2157-5	Spring Loaded	3
6	H.C.B-A2157-6	Saddle	1
7	H.C.B-A2157-7	Screw	3
8	H.C.B-A2157-8	Nut	9
9	H.C.B-A2157-9	Screw	3
10	H.C.B-A2157-10	Screw	3
11	H.C.B-A2157-11	Load Pin	1
12	H.C.B-A2157-12	Grip	2
13	H.C.B-A2157-13	Set Screw	2

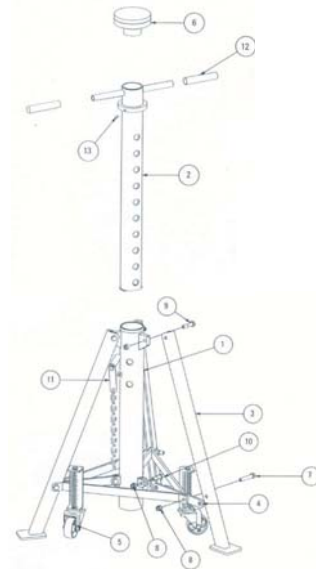

Specification	Width	Length	Height	stroke	N.W.	G.W.
Size	803.3 mm	698.5 mm	870 mm	540 mm	45 kgs	47 kgs

H.C.B-A2158

TRUCK JACK STAND 15,000 LBS

卡車千斤頂 15,000 磅

- Spring loaded caster for easy positioning and portability.
- 彈簧支撐腳輪可協助定立和移動。

Item	Part No.	Description	Q'ty
1	H.C.B-A2158-1	Main Tube	1
2	H.C.B-A2158-2	Removal Tube	1
3	H.C.B-A2158-3	Set Screw	2
4	H.C.B-A2158-4	Spring	1
5	H.C.B-A2158-5	Load Pin	1
6	H.C.B-A2158-6	Leg	3
7	H.C.B-A2158-7	Link	3
8	H.C.B-A2158-8	Spring Loaded	3
9	H.C.B-A2158-9	Screw	3
10	H.C.B-A2158-10	Screw	3
11	H.C.B-A2158-11	Screw	3
12	H.C.B-A2158-12	Anti-Nut	9
13	H.C.B-A2158-13	Grip	2
14	H.C.B-A2158-14	Swivel Adapter	1
15	H.C.B-A2158-15	Set Screw	1
16	H.C.B-A2158-16	Spindle Assy	1
17	H.C.B-A2158-17	Saddle	1

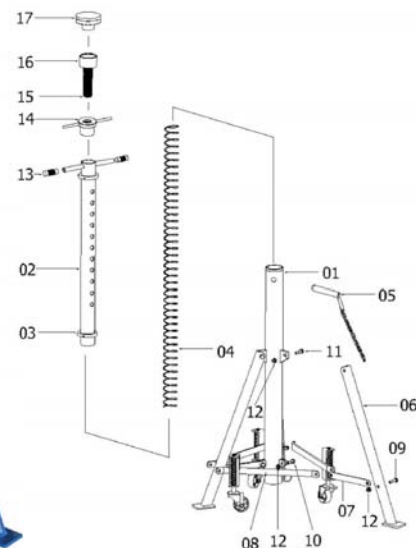

Specification	Width	Length	Height	stroke	N.W.	G.W.
Size	803.3 mm	698.5 mm	Max:2096.5mm/ Min:1426.5mm	670 mm	58 kgs	61 kgs



H.C.B-B2158

TRUCK JACK STAND 33,000 LBS

卡車千斤頂 33,000 磅



Specification	Width	Length	Height	stroke	N.W.
Size	948.5 mm	821.5 mm	Max:2074 mm Min:1389 mm	685 mm	98 kgs

H.C.B-A2226

JACK STAND (18")

貨車頂車架 (18")

H.C.B-B2226

JACK STAND (24")

貨車頂車架 (24")

H.C.B-C2226

JACK STAND (28")

貨車頂車架 (28")

- To adjust the height by turning nut and stud.
- 以螺帽和螺栓來調整高度。



Item No./ 編號	capacity/ 承載重量 (噸)	Height/ 高度 (mm)	Base/ 底座 (mm)	Qty' /Carton 數量 / 箱	N.W. / 淨重 (kg)	G.W. / 毛重 (kg)	Cuft / 材數
A2226	12	456~710	Ø 467	1	18.5	19.5	0.7
B2226	12	614~868	Ø 590	1	21	22	1
C2226	12	710~1065	Ø 670	1	25	26	1

H.C.B-A2009

CLUTCH ALIGNMENT TOOL (IRON)

離合器對孔校正器 (鐵)

- Align single disc clutches on most of vehicles, light trucks & tractors. Properly aligns clutch plate by fitting cone into bushing or bearing.
- Size of 8 adaptors: from 0.465"(11 mm) to 0.980" (24.9 mm)
- N.W.: 0.7 Kgs



- 可校正大部份汽車、輕型卡車和拖車上的單碟離合器。將圓錐伸入導向鐵套或培林中，即可校正離合器盤。
- 8款接頭尺寸：0.465" -0.98" (11 mm - 24.9 mm)
- 淨重：0.7 公斤

H.C.B-A2021

SOCKET TOOL KIT (34 PCS)

星型中空,E型綜合套筒組 (34 PCS)

- Content :
- 5 pcs 1/4" Star-E socket: E4, E5, E6, E7, E8
- 4 pcs 3/8" Star-E socket: E10, E12, E14, E16
- 2 pcs 1/2" Star-E socket: E18, E20
- 2 pcs 1/2" TORX bit socket: T55, T60
- 4 pcs 3/8" TORX bit socket: T40, T45, T47, T50
- 1 pc 1/2" TAMPER. TORX bit socket:T55
- 3 pcs 3/8" TAMPER. TORX bit socket:T40, T45, T50
- 7 pcs 1/4" TORX bit socket:T8, T10, T15, T20, T25, T27, T30
- 6 purchase 1/4" TAMPER. TORX bit socket:T10, T15, T20, T25, T27, T30
- N.W.: 1.5KGS



Star-E



TORX bit



TAMPER. TORX



H.C.B-A2022

18 PCS IMPACT HEXAGON & TX-STAR WRENCH KIT

6角,星型凸套筒組 (18 PCS)

- Specification/ 規格 :
- Hexagon/ 六角 : H5, H6, H7, H8, H10, H12, H14, H17
- TX-Star / 星形 : T30, T40, T45, T50, T55, T60, T70
- Dr. 1/2 x 125 mm extension bar/ 延長桿
- Dr. 1/2 x 250 mm sliding T-handle / T形扳手
- Dr. 1/2 ratchet handle / 棘輪扳手
- Applicable: most of cars/ 適用大部份車輛
- N.W.: 3.3 kgs / 淨重 :3.3 公斤



TX-STAR



Hexagon





H.C.B-A2086

160 PCS COMPREHENSIVE TOOL KIT

160 PCS 專業級套筒組

2 / 23.5 / 24.5 / 1.42"

■ Specification

13-1/4" socket:

3.5, 4, 4.5, 5, 5.5, 6, 7, 8, 9, 10, 11, 12, 13 mm

5-1/4" deep socket: 5.5, 6, 7, 8, 9 mm

1-1/4" ratchet handle

1-1/4" spanner handle

1-1/4" bit adapter

2-1/4" extension bar 2" & 4"

1-1/4" sliding T-Bar

1-1/4" universal joint

18-1/4" bit socket

8-3/8" socket: 10, 13, 14, 15, 16, 17, 18, 19 mm

6-3/8" deep socket: 10, 11, 12, 13, 14, 15 mm

3-3/8" spark plug: 16, 18, 21 mm

8-3/8" star socket: 8, 10, 11, 12, 14, 16, 18, 20 mm

1-coupler 3/8"x5/16"

1-3/8" ratchet handle

1-TM head 3/8" F x 1/2" m

1-Adapter 3/8" F x 1/4" m

2-3/8" extension bar 3" & 10"

1-3/8" universal joint

1-3/8" bit adapter

10-1/2" socket: 17, 19, 20, 21, 22, 24, 27, 30, 32, 34 mm



4-1/2" power socket: 17, 19, 21, 23 mm

3-1/2" deep socket: 17, 19, 22 mm

1-Coupler 1/2"x5/16"

1-1/2" ratchet handle

2-1/2" extension bar 5" & 10"

1-TM head 1/2" F x 3/8" m

1-Adapter 1/2" F x 3/8" m

1-1/2" universal joint

34-5/16" bit

3-Gear wrench: 8x10, 13x15, 17x19 mm

12-Combination wrench.

8, 10, 11, 12, 13, 14, 15, 16, 17, 18, 19, 22 mm

11-Hexkey: 1.5, 2, 2.5, 3, 4, 5, 6, 7, 8, 10 mm

H.C.B-A2145

94 PCS (Dr. 1/4" & 1/2") TOOL KIT

94 PCS (Dr. 1/4" & 1/2") 套筒組

■ Contents:

13 pcs 1/4" Socket: 4/4.5/5/5.5/6/7/8/9/10/11/12/13/14mm

18 pcs 1/2" Socket: 10/11/12/13/14/15/16/17/18/19/20/21/22/23/

24/27/30/32 mm

5 pcs 1/2" Deep Socket: 14/15/17/19mm

8 pcs 1/4" Deep Socket: 6/7/8/9/10/11/12/13 mm

1 pc 1/2" Ratchet handle

1 pc 1/4" Ratchet handle

2 pcs 1/4" Extension Bar 50 & 100mm

2 pcs 1/2" Extension Bar 125 & 250 mm

1 pc 1/4" Sliding T handle

1 pc 1/2" Universal joint

2 pcs 1/2" Spark Plug Socket: 16 & 21 mm

1 pc 1/4" Spanner handle

1 pc 1/4" Universal joint

1 pc T-M head

1 pc Coupler

3 pcs Hex. key: 1.5/2/2.5 mm

1 pc 1/4" Flexible Extension Bar 150 mm

17 pcs 1/4" Bit-Sockets: (-)4/5.5/7, (+)#1/2, (*)#1/2, (H)3/4/5/6,

(T)8/10/15/20/25/30

15-Bits: (-)8/10/12, (+)#3/4, (*)3/4, (H)8/10/12/14, (T)40/45/50/55



H.C.B-A2166

16 PCS (Dr. 3/4" & 1") SQ. DRIVE INSERT BIT SOCKET KIT

16 PCS 套筒組 (Dr. 3/4" & 1")

3 / 19.8 / 20.3 / 1.03'

- ★ 5-107mm (L), Tx-Star : T60, T70, T80, T90, T100
- 4-107mm (L), Hexagon : 17, 19, 22, 24 mm
- ⊙ 4-107mm (L), Star-E : E18, E20, E22, E24
- 1-3/4" Sq. Drive, Hexagon Socket : 22 mm
- 1-1" Sq. Drive, Hexagon Socket : 22 mm
- 1-Hexagon L-Key : 4 mm



H.C.B-A2168

9 PCS STAR-E SOCKET KIT
(E10/E11/E12/E14/E16/E18/E20/E22/E24)

9 PCS E 型套筒組
(E10/E11/E12/E14/E16/E18/E20/E22/E24)

- Dr. 1/2" E-Socket: E10, E11, E12, E14, E16, E18, E20, 22, E24



H.C.B-A2209

DIESEL INJECTOR SEAT CUTTER KIT

柴油噴油嘴座清除器

20 / 19.2 / 19.7 / 2'

- To clean and re-cutting the injector seat of modern common rail diesel engines.
- 可清除柴油引擎的噴油嘴座

- Specification and Application:

No.	Specification / 規格	Q'ty	Applicable/ 適用車種
1	19 mm x 17 mm Flat	1 pc	Benz CRD
2	17 mm x 17 mm Flat	1 pc	BMW, Peugeot, Citroen and Renault
3	15 mm x 19 mm Flat	1 pc	For most of autos and trucks
4	21 mm x 17 mm Angled	1 pc	Fiat and Iveco
5	T Handle	1 pc	
6	Pilot Post	1 pc	



H.C.B-A2107

EXTRA LONG OFFSET BOX WRENCH KIT (8 PCS)

加長型梅花扳手組 (8 PCS)



Item	SPEC.(mm) 規格	Length 長度	Item	SPEC.(mm) 規格	Length 長度
A2107-1	8x10	235	A2017-5	14x17	370
A2107-2	10x12	295	A2017-6	16x18	405
A2107-3	12x14	330	A2017-7	17x19	405
A2107-4	13x15	370	A2017-8	22x24	435

H.C.B-B2107

EXTRA LONG OFFSET BOX WRENCH KIT (6 PCS) (10x12, 12x14, 13x15, 16x18, 17x19, 22x24 mm)

加長平型梅花扳手組 (6 PCS)
(10x12, 12x14, 13x15, 16x18, 17x19, 22x24 mm)



H.C.B-A2177

5 PCS HALF-MOON RING WRENCH

5 PCS 扳手 (半月型)

- Material: Chrome vanadium, Shiny finished
- 材質：鉻釩鋼·亮面處理



H.C.B-A2177-5

H.C.B-A2177-4

H.C.B-A2177-3

H.C.B-A2177-2

H.C.B-A2177-1

SIZE	L(mm)	ITEM NO.	C(mm)	B(mm)	C1(mm)	B1(mm)	T(mm)	WT(g)
10x12	141	H.C.B-A2177-1	15.6	18.2	6.6	6.5	4.2	56
11x13	166	H.C.B-A2177-2	18.2	21.0	8.2	8.0	4.9	93
14x17	190	H.C.B-A2177-3	22	25	9.2	8.2	5.3	134
16x18	220	H.C.B-A2177-4	25.5	28	9.6	8.8	5.6	180
19x22	256	H.C.B-A2177-5	28.6	32.5	11.1	10.1	6.6	240

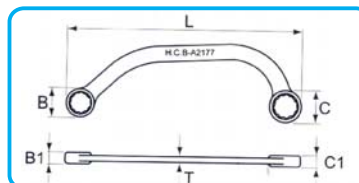

H.C.B-C1641

NEW

UNIVERSAL LOCKING RING TOOL PAT.

萬能扣環鉗

- C1641 allows fast, easy removal of the C-ring without damaging it.
- Range: Dimensions from 65 mm ~ 175 mm C-Ring.
- With larger main body, it applies mainly on bigger C-ring than A1641 does.

Instructions:

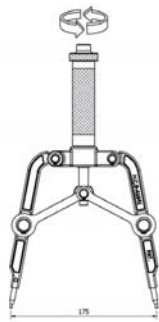

Feature:

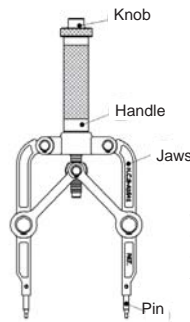

The handle is stationary, and won't rotate with the knob. With this design, one hand can hold the handle, and the other can turn the jaws for wide range adjustment.

Narrowest Range: 65 mm Widest Range: 175 mm



H.C.B-B1641

NEW

UNIVERSAL LOCKING RING TOOL PAT. D178574

萬能扣環鉗

- A new type of lock ring tool which makes dismounting and mounting of wheel bearing lock rings very easy.
- The tool is designed to fit the larger lock rings for example the lock ring on the axle shaft or other lock rings on passenger cars, light commercial vehicles and trucks. (Ex: IVECO)
- 此新式扣環鉗可以非常輕鬆的拔除或安裝輪軸培林的C型環。
- 此扣環鉗可適用於較大型之C型環，如：轎車輪軸上之C型環，或其它轎車、輕型商用車及卡車上的C型環。(例：IVECO)

- Content: 扣環插銷規格
- A1641-04 Circlip pin 2.5 mm, 2 pcs
- A1641-05 Circlip pin 3 mm, 2 pcs
- A1641-06 Circlip pin 3.5 mm, 2 pcs
- A1641-07 Circlip pin 3.8 mm, 2 pcs
- A1641-08 Circlip pin 2.5 mm, 2 pcs with 45 degree angle
- A1641-09 Circlip pin 3 mm, 2 pcs with 45 degree angle
- A1641-10 Circlip pin 3.5 mm, 2 pcs with 45 degree angle
- A1641-11 Circlip pin 3.8 mm, 2 pcs with 45 degree angle
- A1641-12 Circlip pin 2.5 mm, 2 pcs with 90 degree angle
- A1641-13 Circlip pin 3 mm, 2 pcs with 90 degree angle
- A1641-14 Circlip pin 3.5 mm, 2 pcs with 90 degree angle
- A1641-15 Circlip pin 3.8 mm, 2 pcs with 90 degree angle



VIDEO



H.C.B-A2170

DIESEL ENGINE COMPRESSION TESTER KIT

柴油引擎汽缸壓力測試工具組



ITEM NO.	APPLICATION	ENGINE	TESTING PORT	THREAD
H.C.B-A2170-02	Ford/Navistar	6.9 and 7.3 liter	glow plug	10mm -1.00
	General Motors	4.3 & 5.7 liter	glow plug	10mm -1.00
	Navistar	6.9 & 7.3 liter	glow plug	10mm -1.00
H.C.B-A2170-03	Audi	all	fuel injector	24mm - 2.00
	Cummins	6 BT, 4.02" bore, 5.9 liter	fuel injector	24mm - 2.00
	Mercedes Benz	cars & trucks with 24mm ports	fuel injector	24mm - 2.00
	Volkswagen	all cars and trucks	fuel injector	24mm - 2.00
H.C.B-A2170-04	Volvo	all cars and trucks	fuel injector	24mm - 2.00
	Cummins	V-185, V-210, V-225, V-555, VT-255, VT-555	fuel injector	
H.C.B-A2170-05	Bacharach	Allow a Bacharach brand adapter to be used with our tester, No. H.C.B-A2170-01.		
H.C.B-A2170-06	Mercedes Benz	12mm is for Model 300 & 300 Turbo diesel from 1978 and the 250 & 350 Turbo models.	glow plug	12mm - 1.25 and 18mm - 1.50
		18mm is for all regular Mercedes Benz engines & model 300 prior to 1978		
H.C.B-A2170-07	Allis Chalmers	6000, 7000, 10000, 11000	fuel injector	
	Bedford	200, 220, 300, 330, 466	fuel injector	
	Case, J.I.	all models not using pencil nozzle	fuel injector	
	Deere, John	404, 466, 531, 619	fuel injector	
	Fiat Allis	8035-02-300, 8035-02-301, 8035-02-302, 8045-02, 8045-03	fuel injector	

	Ford Tractor	all	fuel injector	
	International Harvester	D/DT 361, D/DT 429, DV462, DV/DVT 550, DT/DV/DVT 573, 361, 407	fuel injector	
	Mack Truck	END 405, 457, 475, 510, 519, 605, 672, 673, 674,	fuel injector	
H.C.B-A2170-07		711, 864, ENDT-673, 675, 676, 865, 866		
	Onan	DSL, MDSL	fuel injector	
	Waukesha	180DLC, 190D, 195D, 197D	fuel injector	
H.C.B-A2170-08	Cummins	These 5.5" bore engines: NH(855 cubic inches), V-6, V-8, V-12 & 903 V-8 Cylindrical PTB	fuel injector	
H.C.B-A2170-09	BMW	2.4 liter	glow plug	12mm - 1.25
	Lincoln Continental Mark VII	1984 and 1985 car models	glow plug	12mm - 1.25
	Peugeot	For Peugeot diesel passenger cars having either 12mm -1.25 or 18mm -1.50mm glow plug port holes	glow plug	12mm - 1.25 and 18mm - 1.50
H.C.B-A2170-10	Chevy Luv	1.8 and 2.2 liter	glow plug	10mm - 1.25
	Isuzu	1.8 and 2.2 liter	glow plug	10mm - 1.25
	Toyota	1.8 liter	glow plug	10mm - 1.25
H.C.B-A2170-11	General Motors	4.3, 5.7, 6.2 liter, 6.5 liter Turbo	glow plug	10mm - 1.25
H.C.B-A2170-12	Detroit Diesel	53, 71, 92, 110, 149, V53, V71 with low or high clamp injector hold down	fuel injector	
H.C.B-A2170-13	Caterpillar	"Capsule" type nozzles including models D-336, 1674, 1676, 3406, 3408 and 3412	fuel injector	
H.C.B-A2170-14	Case, J.I.	70 series, 188 & 207 C.I.D. pencil nozzle	fuel injector	
	Caterpillar	1100 and 3208 series	fuel injector	
	Deere, John	early 300, 400 and 500 series, 276, 404, and 531 C.I.D.	fuel injector	
	Waukesha	D155D	fuel injector	

H.C.B-B2192

OIL DRAIN REPAIR KIT

油底殼螺絲更換組

8 / 20 / 21 / 2.2'

- Renew the thread and replace a new oil drain plug.
- Six popular sizes fit nearly all applications.
- Material: Tap:SKS3
Oil drain plug: 1015
Washer: Copper

- 重製螺牙並更換新的油底殼螺絲。
- 六種最常用的規格，可適用於大部份車種。
- 材質：攻牙器：SKS3
油底殼螺絲：1015
墊片：銅

Size	Tap	Oil drain plug	Washer
M13 x P1.25	1 pc	6 pc	12 pcs
M13 x P1.5	1 pc	6 pc	12 pcs
M15 x P1.5	1 pc	6 pc	12 pcs
M17 x P1.5	1 pc	6 pc	12 pcs
M20 x P1.5	1 pc	6 pc	12 pcs
M22 x P1.5	1 pc	6 pc	12 pcs



H.C.B-A1320

SPECIAL SOCKET FOR TRUCK (Dr. 3/4", 6 POINTS)

卡車特殊套筒 (Dr. 3/4", 6 角)



H.C.B-B1320

SPECIAL SOCKET FOR TRUCK (Dr. 1", 6 POINTS)

卡車特殊套筒 (Dr. 1", 6 角)

- Sample of application of A1320-95 & B1320-95:
To remover / install Renault 10 wheels trailer (P370) drive axle nut.
B1320-90: DAF (CF) (Euro 5) front shaft
B1320-105: DAF (CF) (Euro 5) lifing shaft
B1320-120: DAF (CF) (Euro 5) drive shaft



- A1320-95 & B1320-95 的使用例：
移除 / 安裝雷諾 10 輪拖車頭 (P370) 的帶動軸螺帽
B1320-90: DAF (CF) 五期環保前輪軸
B1320-105: DAF (CF) 五期環保舉升軸
B1320-120: DAF (CF) 五期環保帶動軸

Specification:

Item no.	Dr.	SW	Item no.	Dr.	SW
H.C.B-A1320-70	3/4"	70mm	H.C.B-B1320-70	1"	70mm
H.C.B-A1320-75	3/4"	75mm	H.C.B-B1320-75	1"	75mm
H.C.B-A1320-80	3/4"	80mm	H.C.B-B1320-80	1"	80mm
H.C.B-A1320-85	3/4"	85mm	H.C.B-B1320-85	1"	85mm
H.C.B-A1320-90	3/4"	90mm	H.C.B-B1320-90	1"	90mm
H.C.B-A1320-95	3/4"	95mm	H.C.B-B1320-95	1"	95mm
H.C.B-A1320-100	3/4"	100mm	H.C.B-B1320-100	1"	100mm
H.C.B-A1320-105	3/4"	105mm	H.C.B-B1320-105	1"	105mm
H.C.B-A1320-110	3/4"	110mm	H.C.B-B1320-110	1"	110mm
H.C.B-A1320-115	3/4"	115mm	H.C.B-B1320-115	1"	115mm
H.C.B-A1320-120	3/4"	120mm	H.C.B-B1320-120	1"	120mm
H.C.B-A1320-125	3/4"	125mm	H.C.B-B1320-125	1"	125mm
H.C.B-A1320-130	3/4"	130mm	H.C.B-B1320-130	1"	130mm
H.C.B-A1320-135	3/4"	135mm	H.C.B-B1320-135	1"	135mm
H.C.B-A1320-140	3/4"	140mm	H.C.B-B1320-140	1"	140mm
H.C.B-A1320-145	3/4"	145mm	H.C.B-B1320-145	1"	145mm
H.C.B-A1320-150	3/4"	150mm	H.C.B-B1320-150	1"	150mm
H.C.B-A1320-155	3/4"	155mm	H.C.B-B1320-155	1"	155mm
H.C.B-A1320-160	3/4"	160mm	H.C.B-B1320-160	1"	160mm
H.C.B-A1320-165	3/4"	165mm	H.C.B-B1320-165	1"	165mm
H.C.B-A1320-170	3/4"	170mm	H.C.B-B1320-170	1"	170mm
H.C.B-A1320-175	3/4"	175mm	H.C.B-B1320-175	1"	175mm
H.C.B-A1320-180	3/4"	180mm	H.C.B-B1320-180	1"	180mm
H.C.B-A1320-185	3/4"	185mm	H.C.B-B1320-185	1"	185mm
H.C.B-A1320-190	3/4"	190mm	H.C.B-B1320-190	1"	190mm
H.C.B-A1320-195	3/4"	195mm	H.C.B-B1320-195	1"	195mm
H.C.B-A1320-200	3/4"	200mm	H.C.B-B1320-200	1"	200mm

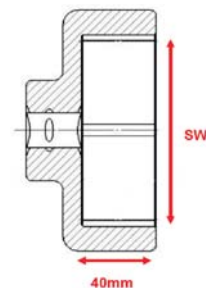

Renault 10 wheels trailer (P370) drive axle nut

Item no.	Dr.	SW	Length
H.C.B-A1320-30	3/4"	30mm	90L
H.C.B-A1320-32	3/4"	32mm	90L
H.C.B-A1320-33	3/4"	33mm	90L
H.C.B-A1320-34	3/4"	34mm	90L
H.C.B-A1320-35	3/4"	35mm	90L
H.C.B-A1320-36	3/4"	36mm	90L
H.C.B-A1320-38	3/4"	38mm	90L
H.C.B-A1320-41	3/4"	41mm	90L
H.C.B-A1320-46	3/4"	46mm	90L





H.C.B-B1320-7090

SPECIAL SOCKET FOR TRUCK (Dr. 1", 70 mm, L: 90 mm)

卡車特殊套筒 (Dr. 1", 70 mm, 長度: 90 mm)

- Size : Dr. 1", 70 mm, length 90 mm
- 尺寸 : Dr. 1", 70 mm, 長度 90 mm



H.C.B-A1488

SPECIAL SOCKET FOR TRUCK (Dr. 3/4", 8 POINTS)

卡車輪軸螺帽套筒 (Dr. 3/4", 8 角)

H.C.B-B1488

SPECIAL SOCKET FOR TRUCK (Dr. 1", 8 POINTS)

卡車輪軸螺帽套筒 (Dr. 1", 8 角)



L: 88 mm

Item	Dr.	SW	Item	Dr.	SW
A1488-70	3/4"	70mm	B1488-70	1"	70mm
A1488-75	3/4"	75mm	B1488-75	1"	75mm
A1488-80 (B1125)	3/4"	80mm	B1488-80 (C1125)	1"	80mm
A1488-85	3/4"	85mm	B1488-85	1"	85mm
A1488-90	3/4"	90mm	B1488-90	1"	90mm
A1488-95 (A1050-8)	3/4"	95mm	B1488-95	1"	95mm
A1488-100 (B1126)	3/4"	100mm	B1488-100 (C1126)	1"	100mm
A1488-105 (A1286)	3/4"	105mm	B1488-105	1"	105mm
A1488-110	3/4"	110mm	B1488-110	1"	110mm
A1488-115 (A1176)	3/4"	115mm	B1488-115	1"	115mm
A1488-120	3/4"	120mm	B1488-120	1"	120mm
A1488-125	3/4"	125mm	B1488-125	1"	125mm
A1488-130	3/4"	130mm	B1488-130	1"	130mm
A1488-135	3/4"	135mm	B1488-135	1"	135mm
A1488-140	3/4"	140mm	B1488-140	1"	140mm
A1488-145	3/4"	145mm	B1488-145	1"	145mm
A1488-150	3/4"	150mm	B1488-150	1"	150mm
A1488-155	3/4"	155mm	B1488-155	1"	155mm
A1488-160	3/4"	160mm	B1488-160	1"	160mm
A1488-165	3/4"	165mm	B1488-165	1"	165mm
A1488-170	3/4"	170mm	B1488-170	1"	170mm
A1488-175	3/4"	175mm	B1488-175	1"	175mm
A1488-180	3/4"	180mm	B1488-180	1"	180mm
A1488-185	3/4"	185mm	B1488-185	1"	185mm
A1488-190	3/4"	190mm	B1488-190	1"	190mm
A1488-195	3/4"	195mm	B1488-195	1"	195mm
A1488-200	3/4"	200mm	B1488-200	1"	200mm



尺寸: Dr. 3/4", 8 角, 105 mm

H.C.B-A1592

SPECIAL SOCKET FOR TRUCK (Dr. 1", 12 POINTS, L: 90 mm)

卡車特殊套筒 (Dr. 1", 12 角, 長度: 90 mm)

- Application: IVECO truck ■ 適用車種: IVECO 卡車
- Size: Dr. 1", 12 POINTS, L: 90 mm ■ 尺寸: Dr. 1", 12 角, L: 90 mm
- Specification:

Item No.	Dr.	SW
H.C.B-A1592-80	1"	80 mm
H.C.B-A1592-85	1"	85 mm
H.C.B-A1592-90	1"	90 mm
H.C.B-A1592-95	1"	95 mm
H.C.B-A1592-100	1"	100 mm
H.C.B-A1592-105	1"	105 mm
H.C.B-A1592-110	1"	110 mm
H.C.B-A1592-115	1"	115 mm
H.C.B-A1592-120	1"	120 mm



H.C.B-A1336

MANUAL LINING PULLER KIT

手動汽缸套拔卸組

- This set removes cylinder lining from most truck (such as FUSO 3.5 tons, 15 tons, 300, HINO 750, VOLVO (FL10,FM12), DAF CF 85 SCANIA 310, buses and other vehicle engines.
- This set doesn't need to removal the head studs.

- 可以取出大部份卡車 (如: FUSO 3.5 噸、15 噸、330、HINO 750 VOLVO(FL10,FM12)、DAF CF 85、SCANIA 310、巴士和汽車的引擎汽缸套。
- 不需移除汽缸頭銷。

VIDEO



Part No.	I.D.-0.1	O.D.-0.1	Application
HCB-A1336-10	Ø119	Ø130	
HCB-A1336-11	Ø129	Ø142	FUSO 330, 350
HCB-A1336-12	Ø126	Ø138.5	SCANIA 310
HCB-A1336-13	Ø134	Ø140	
HCB-A1336-14	Ø136.5	Ø147	FUSO V8 330
HCB-A1336-15	Ø126	Ø140	SCANIA 320
Optional(選購)			
HCB-A1336-16	Ø120	Ø125	VOLVO(FL10)
HCB-A1336-17	Ø130	Ø135	VOLVO(FM12) DAF CF 85 Euro3
HCB-A1336-18	Ø129.5	Ø138.5	DAF
HCB-A1336-19	Ø113.9	Ø127.5	SCANIA L94(SERIES 4)

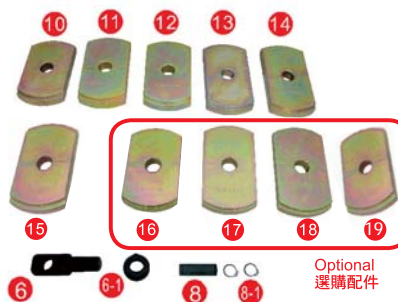

H.C.B-A1337

TRUCK K/D RACK - MANUAL PAT. I 380921

手動卡車多功能拆裝架

- The gear type truck K/D rack is designed for engine or transmission maintenance.
- Replaceable holding base to fit any kinds of engine and transmission.
- Padlocked turbine case helps technicians check the turbine easily.
- The gear and engine / transmission can be rotated on 360 degrees synchronal both clockwise and reverse.
- Stop at any angles if necessary.
- Extendable stand for storage.
- Capacity: 2000~3000LB(900~1360KG)
- Size: L: 1600 mm (extended)/ 1140 mm W: 1000 mm H: 1360 mm
- N.W.: 347 Kgs

- 專為維修引擎、變速箱而設計。
- 可更換式的固定座適用於各種引擎、變速箱。
- 鉸鏈式箱門，方便渦輪日常保養。
- 可 360°、雙向轉動引擎、變速箱。
- 可固定在任何角度。
- 伸縮腳架，方便收藏儲放。
- 載重量：2000~3000 磅 (900~1360 公斤)
- 尺寸：長：1600 mm (延伸)/ 1140 mm
寬：1000 mm 高：1360 mm
- 淨重：347 公斤



H.C.B-B1337

TRUCK K/D RACK - ELECTRICAL PAT. I 380921

電動卡車多功能拆裝架

- The best truck K/D rack for both engine and transmission maintenance.
- Replaceable holding base to fit any kinds of engine and transmission.
- Padlocked turbine case helps technicians check the turbine easily.
- The gear and engine / transmission can be pivoted on 360 degrees both clockwise and reverse.
- Stop at any angles and any time if necessary.
- Driven by 2HP motor. The patented design of H.C.B
- Extendable stand for storage.
- Capacity: 2000~3000LB(900~1360KG)
- Specification of power :

Power 2HP motor	■ Size:
Resource Single-phase, 220V	L: 1600 mm (extended)/ 1140 mm
Control Wire 3 m	W: 1000 mm
Power Cored 5 m	H: 1360 mm
- N.W.:376 Kgs

- 專為維修引擎、變速箱而設計。
- 可更換式的固定座適用於各種引擎、變速箱。
- 鉸鏈式箱門，方便渦輪日常保養。
- 可 360°、雙向轉動引擎、變速箱。
- 可固定在任何角度。
- 本公司專利設計，由 2HP 馬達驅動。
- 伸縮腳架，方便收藏儲放。
- 載重量：2000~3000 磅 (900~1360 公斤)
- 馬達規格：

2HP 馬達	■ 尺寸：
單向，220V	長：1600 mm(延伸)/ 1140 mm
控制器線長 :3 m	寬：1000 mm
電源線長 :5 m	高：1360 mm
- 淨重：347 公斤



VIDEO



H.C.B-C1337

TRANSMISSION FIXING BASE

卡車變速箱固定座

- Size: 690 mm x 770 mm x 600 mm
- Application: Most of Japanese trucks.
- 尺寸 :690 mm x 770 mm x 600 mm
- 適用車種 : 大部份的日系卡車



H.C.B-D1337

DIFFERENTIAL FIXING BASE

卡車差速器固定座

- Application: UD WC520 two-way differential.
- 適用車種 : UD WC520 雙轉差速器



H.C.B-E1337

CUMMINS (EURO 4)/DAF(LF 65) 17 TONS ENGINE FIXING BASE

康明斯 (四期環保)/DAF(LF 65) 17 噸 引擎固定架

- Application: CUMMINS (Euro 4)/ DAF (LF 65) 17 Tons
- Screw size : M12xP1.75x35 L (Q'ty: 6 pcs)
- 適用車種 : 康明斯引擎 四期環保 / DAF (LF 65) 17 噸
- 螺絲尺寸 : M12 x P1.75 x 35 L (數量 : 6 支)



H.C.B-F1337

ISUZU (MYY 5T) TRUCK TRANSMISSION FIXING BASE (ACCESSORY)

ISUZU (MYY 5T) 卡車變速箱固定座 (配件)

- Combine with H.C.B-A1337 or B1337.
And it must work with H.C.B-C1337
- Application: ISUZU (MYY 5T) transmission
- Screw size: M10 x P1.5 x 40L (Q'ty:12 pcs)
M10 x P1.5 x 70L (Q'ty:10 pcs)



- 請與 H.C.B-A1337 或 B1337 一起使用, 務必與 C1337 配合使用
- 適用車種 : ISUZU (MYY 5T) 卡車變速箱
- 螺絲尺寸 : M10 x P1.5 x 40 長 (12 支)
M10 x P1.5 x 70 長 (10 支)



H.C.B-G1337

ISUZU (4JJ1 & 4HK1) TRUCK ENGINE FIXING BASE (ACCESSORY)

ISUZU (4JJ1 & 4HK1) 卡車引擎固定架 (配件)

- Combine with H.C.B-A1337 or B1337.
- Application: ISUZU (4JJ1 & 4HK1) TRUCK ENGINE
- 請與 H.C.B-A1337 或 B1337 一起使用
- 適用車種: ISUZU 4JJ1 / 4HK1 引擎

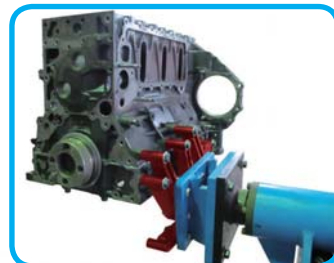

H.C.B-H1337

ISUZU (6HK1) TRUCK ENGINE FIXING BASE (ACCESSORY)

ISUZU (6HK1) 卡車引擎固定架 (配件)

- Combine with H.C.B-A1337 or B1337.
- Screw size: M10 x P1.5 x 40L (Q'ty: 7 pcs)
- Application: ISUZU truck (6HK1) engine
- 請與 H.C.B-A1337 或 B1337 一起使用
- 螺絲尺寸: M10 x P1.5 x 40L (數量: 7 支)
- 適用車種: ISUZU 6HK1 引擎



H.C.B-I1337

ISUZU (MZW 6P) TRUCK TRANSMISSION FIXING BASE (ACCESSORY)

ISUZU (MZW 6P) 卡車變速箱固定架 (配件)

- Combine with H.C.B-A1337 or B1337, and it must work with H.C.B-C1337.
- Screw size: M10 x P1.5 x 40L (Q'ty:12 pcs)
M10 x P1.5 x 50L (Q'ty:12 pcs)
- Application: ISUZU (MZW 6P) truck transmission
- 請與 H.C.B-A1337 或 B1337 一起使用, 務必與 C1337 配合使用
- 螺絲尺寸: M10 x P1.5 x 40 長 (12 支)
M10 x P1.5 x 50 長 (12 支)
- 適用車種: ISUZU (MZW 6P) 卡車變速箱



H.C.B-J1337

HINO (JO8C) 17 TONS TRUCK ENGINE FIXING BASE (ACCESSORY)

HINO (JO8C) 17 噸卡車引擎固定架 (配件)

- Combine with H.C.B-A1337 or H.C.B-B1337.
- Application: HINO (JO8C) 17 tons truck, buses.
- Screw size: M8 x P1.25 x 30L (Q'ty: 2 pcs),
M10 x P1.5 x 35L (Q'ty: 5 pcs)
- 請與 H.C.B-A1337 或 H.C.B-B1337 一起使用.
- 適用車種: HINO (JO8C) 17 噸卡車, 遊覽車
- 螺絲尺寸: M8 x P1.25 x 30L (2 支),
M10 x P1.5 x 35L (5 支)

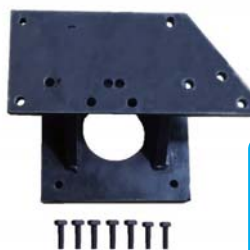

H.C.B-K1337

ISUZU (6WG1/6WF1) TRUCK ENGINE FIXING BASE (ACCESSORY)

ISUZU (6WG1/6WF1) 卡車引擎固定架 (配件)

- Please use with H.C.B-A1337 or B1337.
- Screw size: M8 x P1.25 x 35 mmL (Q'ty: 12 pcs)
- Application: ISUZU truck (6WG1/6WF1) engine

- 請與 H.C.B-A1337 或 H.C.B-B1337 一起使用。
- 螺絲尺寸：外六角鋼螺絲 M8 x P1.25 x 35 mmL (數量：12 支)
- 適用車種：ISUZU (6WG1/6WF1) 卡車引擎

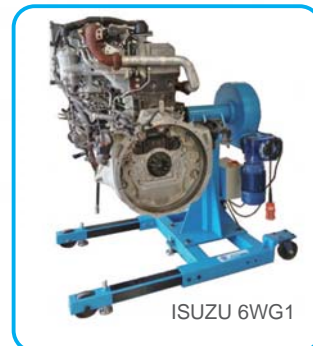

H.C.B-L1337

NEW

ISUZU TRUCK FVR DIFFERENTIAL FIXING BASE

ISUZU 卡車 FVR 差速器固定架

- It must use with H.C.B-A1337 or B1337.

	Size	Q'ty
Screw	M16*P2.0*75L	2
	M16*P2.0*50L	4
Nut	M16*P2.0	6

- Application: ISUZU (FVR) truck differential
- 請務必搭配 H.C.B-A1337 或 B1337 一起使用

	Size	Q'ty
螺絲	M16*P2.0*75L	2
	M16*P2.0*50L	4
螺母	M16*P2.0	6

- 適用車種：ISUZU (FVR) 卡車差速器



H.C.B-M1337

NEW

ISUZU (CXZ 10PE1) TRUCK ENGINE FIXING BASE (ACCESSORY)

ISUZU (CXZ 10PE1) 卡車引擎固定座 (配件)

- It must combine with H.C.B-A1337 or B1337.
- When engineers do maintenance job for ISUZU (CXZ 10PE1) engine, M1337 will be needed to fix the engine.
- Application: ISUZU (CXZ 10PE1) TRUCK

- 請務必搭配 H.C.B-A1337 或 B1337 一起使用
- 當 ISUZU (CXZ 10PE1) 引擎需要進行維修保養時，一般工具沒有辦法穩固的固定住引擎，為此設計 M1337 將引擎固定以便做維修保養的工作。
- 適用車種：ISUZU (CXZ 10PE1) 卡車



H.C.B-D1339

NEW

TRUCK KING PIN PRESS (75 TONS) DE. PAT.M459081

大王銷拆卸機 (75 噸)

Product features:

- New version of chassis developed from years experience allows user to move this king pin press easily, provide better stability, and better chassis figure which can prevent king pin press from contacting the wheel axle or any other part.
- A wide handle bar behind allows user to move this king pin press more easily.
- There are peg boards on the left and right which allow user to hang their necessary tools to increase working efficiency.
- Multiple joints allow any angle adjustment. (The press frame can be rotated forward, backward, clockwise, and counterclockwise.)
- A hand wheel behind which can adjust the height of the press frame.
- A powerful 75 tons hydraulic cylinder with efficient H.C.B-B3036 pump (1800 c.c.) can easily, quickly remove the rusted or stuck king pin.
- Including numerous adapters allows the application on most European and Japanese trucks.
- Application: European and Japanese trucks.



- 根據多年經驗開發的新版設備，讓技師輕鬆移動大王銷，提供更好的穩定性，以及可延伸的底座，可防止大王銷接觸到輪軸或任何零件。
- 後面設有寬把手，讓使用者可以更輕鬆地移動此設備。
- 左側和右側附有掛板，使用者可依照他們喜好掛上必要的工具以提高工作效率。
- 允許任何角度調整。(其框架可以向前，向後，順時針和逆時針旋轉。)
- 後方有一個手輪，可以調整框架的高度。
- 功率強大的 75 噸液壓油缸，配有高效的 H.C.B-B3036 氣動幫浦 (1800 c.c.)，可輕鬆快速地拆除生鏽或卡住的大王銷。
- 包含多個適配器可適用在大部分的卡車
- 可廣泛的應用在歐系與日系卡車。

H.C.B-C1339

TRUCK KING PIN PRESS (75 TONS) DE. PAT. M459081

大王銷拆卸機 (75 噸)

- King Pin bearing will loosen after driving for long-term period and this will cause front wheel alignment problem and it would be dangerous to drivers.
- Description:
 1. This press can install and remove KING PIN on European trucks and Japanese trucks for replacing bearing or sleeve.
 2. Save time, labor and money!
 3. With the revised bar, you can turn it 360°.
- Product features:
 1. Have great mobility
 2. It can be upwards and downwards (rotatable 180°) depends on position of King pin when assembly or disassembly.
 3. With 75 tons hydraulic cylinder & H.C.B-B3036 pump (1800 c.c.)
- Application: European trucks & Japanese trucks.

VIDEO



- 產品特色：
在使用過程中，具及高度靈活性
此設備之 Y 型架可依據大王銷位置翻轉，旋轉角度達 360°。配有 75 噸油壓缸與 H.C.B-B3036 汽動幫浦 (1800 c.c.)
- 適用車種：歐系卡車與日系卡車

H.C.B-A1339

TRUCK KING PIN PRESS (30 TONS) DE. PAT. M459081

大王銷拆卸機 (30 噸) CE

- Turn the handle and adjust angles to push out stubborn king pin and anchor pin.
 - Application: Most of trucks and buses.
 - To combine with H.C.B-B3036.
 - Size: 1120 mm(L) x 520 mm(W) x 910 mm(H)
 - Capability: 30 tons
- 轉動手把、調整角度來拉出卡住的大王銷、固定銷。
 - 適用車種：大部份的卡車、遊覽車
 - 搭配 H.C.B-B3036 使用。
 - 尺寸：1450 mm(長) x 500 mm(寬) x 1550 mm(高)
 - 油壓缸：30 噸

VIDEO



H.C.B-A2050

CAST STEEL SWIVEL-BASE VISE (6")

老虎鉗 (6")

H.C.B-A2050-1

CAST STEEL SWIVEL-BASE VISE (8")

老虎鉗 (8")

H.C.B-A2050-2

CAST STEEL SWIVEL-BASE VISE (10")

老虎鉗 (10")

H.C.B-B2050

CAST IRON VISE (6")

老虎鉗 (6")

- 360° swivel base
 - Material: High quality cast iron
- 360° 旋轉底座
 - 材質：高級鑄鐵



H.C.B-B2050

H.C.B-A2094

TWO WAY OIL FILTER WRENCH (60~80 mm)

二爪正反轉機油芯扳手 (60~80 mm)

50 / 24.9 / 27.2 / 1.78'

- The tool is used for removing and installing the oil filter
- Use with Dr. 1/2" or 21 mm wrench.
- Size: range 60~80 mm

- 可用來拆卸和安裝機油芯。
- 可搭配 Dr. 1/2" 或 21 mm 扳手使用。
- 尺寸：60~80 mm



H.C.B-B2094

TWO WAY OIL FILTER WRENCH (80~110 mm)

二爪正反轉機油芯扳手 (80~110 mm)

25 / 24 / 25 / 1.6'

- The tool is used for removing and installing truck oil filter.
- The serrate design makes it set in place.
- Use with Dr. 1/2" or 22 mm wrench.
- Size: range 80-110 mm

- 可用來拆卸和安裝機油芯。鋸齒狀設計，可將工具固定在正確位置。
- 可搭配 Dr. 1/2" 或 22 mm 扳手使用。
- 尺寸：80~110 mm



H.C.B-D2094

TWO WAY OIL FILTER WRENCH (104~150 mm)

二爪正反轉機油芯扳手 (104~150 mm)

- The tool is for removing and reinstalling oil filter.
- Use with Dr. 1/2" or 21 mm wrench.
- Size: range 104~150 mm
- Application: European, Japanese, American cars and FUSO 10.5~17 tons EURO 4.

- 可用來拆卸和安裝機油芯。
- 可搭配 Dr. 1/2" 或 21 mm 扳手使用。
- 尺寸：104~150 mm
- 適用車種：歐系、日系、美系車輛及 FUSO 四期環保 10.5~17 噸卡車



H.C.B-B2121

PORTABLE POWER STATION (FOR SEDAN)

電霸 (汽油車, 柴油車用)

3 / 26 / 26.5 / 2.03'

- Don't worry when your car's battery is dead.
- Prevent audio or computer from shutting down when changing the car battery.
- Power supplier for home electric appliances.
- Emergency power supply.
- Easy and quick charge.
- Portable, rechargeable, cordless, easy to carry along in vehicles or boats.
- Powerful enough to start engine.
- No need other vehicle or booster cables.
- Safe and sealed battery won't be leak or spill.
- Polarity protection device if clamps connected to battery poles in reverse. And prevent clamps from sparking if the two clamps touched together.



- 當車輛電瓶沒電時，毋需擔心。
- 可避免在更換電瓶時，發生音響或電腦當機。
- 可使用家用電源來充電。
- 緊急的電源供應器。
- 充電簡單、快速。
- 手提、可重覆充電、無線，易於攜帶在車或船上。
- 強效電力，可啟動引擎。
- 不需要其他車輛或電纜。
- 安全、密封式電池、不用擔心溢漏。
- 電極保護裝置可避免接錯電或兩個夾子互相接觸引發的短路。

H.C.B-C2121

PORTABLE POWER STATION (230V/ 50Hz)

電霸 (230V/ 50HZ)

2 / 18.5 / 19 / 1.6'

- LED Operation Function:
The power station voltage level is indicated by the LED's:
Green >12.8 V Yellow 12.2-12.7V Red < 12V
- Low voltage warning-buzz warning for low battery and naturally discharge/ unload the voltage down to 7V ± 0.5V.
- LED 指示功能：電霸的電量可由 LED 的燈色來表示。
綠 >12.8V 黃 12.2-12.7V 紅 <12V
- 低電量、或電量不足 7V±0.5V 時，會響起警告聲。

Battery LED indicators



H.C.B-D2121

PORTABLE POWER STATION (FOR VEHICLE)

電霸 (電力士)

6 / 23.5 / 24 / 1.11'

- It's the lightest in the market, the weight only 3.3 kg , easy operation and store.
- Powerful enough to start engine of under 3500 c.c. vehicle
- It can supply power alone , don't need another vehicle
- The battery charger is designed automatic disconnection power supply so battery life can be prolonged
- It also can supply for lots of equipment of vehicle (ex. mobile phone , intercom of vehicle, vacuum cleaner)
- 淨重 3 公斤，是市售最輕的電霸。便於操作和存放。
- 強效的電力，足以發動 3500 c.c. 以下的車輛引擎。
- 可單獨供電，不需藉助其他的車輛。
- 自動斷電設計，可延長電霸的壽命。
- 也可以做為車上其他設備的電源。(例如：手機、對講機和吸塵器)



H.C.B-A1502

20 TONS AIR/HYDRAULIC FLOOR JACK-LOW PROFILE

20 噸氣動 / 油壓千斤頂 (超低型)

Intended use:

- Heavy duty truck, agricultural and heavy construction equipment.
Ideal for loaded truck and trailer roadside service calls.

Features

- Long handle with 36-1/2" reach helps in positioning jack under vehicles with low overhang.
- May be stored in a vertical position.
- Hand grip also works as a stand to store the jack in a vertical position.
- Compact design fits easily between tandem wheels.
- Removable extension screw is used with the two 4" extension adapters (included) for added height when necessary.
- Self-retracting ram eliminates manual lowering of the jack.
- Convenient push button air valve connected to an in-line filter prohibits contamination from entering the air/hydraulic system.



Low lift Height	High Lift Height	Stroke	Screw Extension	Base Size	P.S.I. Range	Shipping Weight
8.625	22.75	4"	2.75"	9.25" x 17.25"	100-130	63 lbs

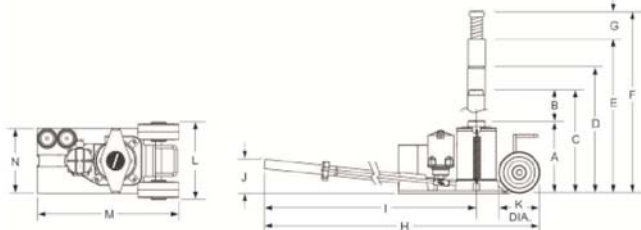

MODEL NUMBER	CAPACITY	PSI RANGE	A	B	C	D	E	F	G	H	I	J	K	L	M	N	SHIPPING WEIGHT (Lbs.)
A1502	20 TON	100-130	8.625"	4"	12.75"	16.75"	20.75"	22.75"	2.75"	53"	36.5"	6.25"	5.25"	9.25"	17.25"	7.75"	63

H.C.B-A1855

NEW

SITRAK TRUCK DRIVE AXLE NUT SOCKET (Dr. 3/4", H60, 6TEETH)

賽德卡卡車帶動軸螺帽套筒 (Dr. 3/4", H60, 6 齒)

- To remove the drive axle nut.
- Applicable: Sitrak truck.
- 使用此工具來移除帶動軸螺母。
- 適用車種：賽德卡卡車



H.C.B-A6001

HYDRAULIC ELEVATOR CART (300 KGS)

油壓升降推車 (300 公斤)

Model 編號	Capacity 載重	Max Height 最大高度	Min Height 最小高度
H.C.B-A6001	300KGS(135.9LBS)	882 mm	267 mm

Table Size 檯面尺寸	Net Weight 淨重	Handle 把手	Wheel 輪子
800 mm x 500 mm	71.2KGS	Fix type	5.4 inch



H.C.B-A2061**HEIGHTENED MANUAL HYDRAULIC PRESS (15 TONS)**

加高型手動油壓床 (15 噸)

- Application: Using for wide range of mechanical parts, like bends deforms combined for reformation or shaft bearing, gear, pressed in or extruded.
 - It is a very useful tool for vehicle or industry mechanical parts maintenance.
 - Feature: High precision hydraulic press for industry.
 - It is designed with double oil-cycle system.
 - Press head assembly is movable to right and left sides.
 - Press head and worktable are adjustable up and down for pressure process.
 - A 600kg/cm² precision pressure gauge is included.
 - N.W.: 160 KGS G.W.: 190 KGS
-
- 適用範圍：大範圍的機械加工。例如：培林、齒輪加工成型。
 - 車輛、工業零件維修的好工具。
 - 高精密度的油壓。
 - 雙油壓循環系統。
 - 壓頭可向左、右轉動。
 - 壓頭和工作檯都可以調整高低。
 - 配備有精密的油壓表。(600 公斤 / 公分²)
 - 淨重：160 公斤，毛重：190 公斤

**H.C.B-A2197****HEAVY DUTY OIL FILTER CHAIN WRENCH (350 mm)**

鏈條式機油濾芯扳手 (350 mm)

24 / 19.2 / 20.2 / 2'

- Applicable for all type of oil filter.
 - Flexible handle for narrow space using.
 - Size available: Ø 60 mm-105 mm.
 - Length of chain: 350 mm.
-
- 適用於各種類型的機油濾芯。
 - 彈性把手，方便在狹小空間中操作。
 - 適用尺寸：Ø60 mm-105 mm
 - 鏈條長度：350 mm

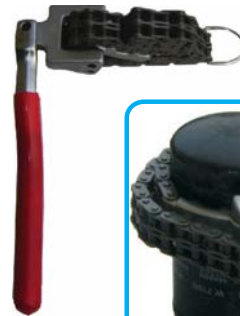
**H.C.B-B2197****HEAVY DUTY OIL FILTER CHAIN WRENCH (520 mm)**

鏈條式機油濾芯扳手 (520 mm)

24 / 22.6 / 23.6 / 1.9'

- Applicable for all type of oil filter.
 - Flexible handle for narrow space using.
 - Size available: Ø 60 mm-160 mm.
 - Length of chain: 520 mm.
-
- 適用於各種類型的機油濾芯。
 - 彈性把手，方便在狹小空間中操作。
 - 適用尺寸：Ø60 mm-160 mm
 - 鏈條長度：520 mm



H.C.B-A2128

AIR HOSE REEL (10 METERS)

捲式風管 (10 米)

4 / 21 / 25 / 4.27'

Specification:

- PU air hose is up to 300 psi (20 bar).
- ABS resin material, against impact.
- High impact / corrosion resistant base.
- Easy install (Reel mounts only requires screw driver for assembly.)
- Ideal for use in commercial / industrial workspaces, automotive garages and machine shops.
- Reel swivels 180° to cover a wide work area or can be installed at 45° · 90° · 135° fixed angle.

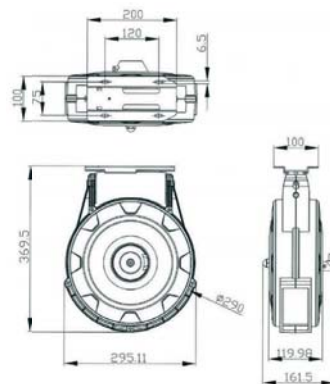

Model	Name	Specifications	Max pressure
H.C.B-A2128	Air hose reel (10 meters)	Ø 8 x Ø 12 x 10M Ø 5/16 x Ø 15/32 x 33FT	300 psi

規格：

- PU 風管可承受 300 psi (20 bar)
- ABS 外殼可防止撞擊
- 防撞 / 防鏽基座組裝容易 (只需螺絲起子即可組裝)
- 適用於商業、工業工作坊、維修廠和機械店
- 180°轉動的捲軸，可提供廣大工作範圍。也可以用 45°、90°和 130°角固定

H.C.B-B2128

CORD REEL

捲式三插座 4 / 21 / 25 / 4.27'

H.C.B-C2128

CORD REEL+110V WORK LIGHT

捲式三插座 + 日光燈 (110V)

4 / 22.5 / 26 / 4.27'

Specification:

- Plug can reach nearly outlet 3.3 FT.
 - ABS resin material against impact.
 - High impact / corrosion resistant base.
 - JIS(Japanese Industrial Standard) standard copper material.
 - Easy to install, lead wire with plug cap, plugs into nearest receptacle.
 - Three outlets for use by three electric tools / appliances simultaneously.
 - Easy installation-(Reel mounts only requires screw driver for assembly).
 - Ideal for use in commercial / industrial workspaces, automotive garages and machine shops.
- Reel swivels 180° to cover a wide work area or can be installed at 45°, 90°, 135° fixed angle.



H.C.B-B2128



H.C.B-C2128

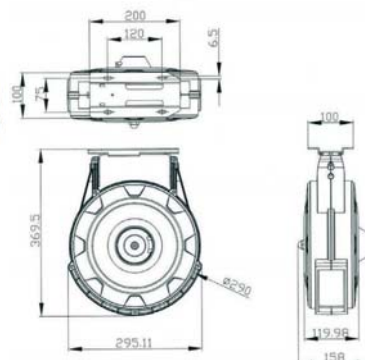

Model	Name	Specification	Max Voltage	AMP
H.C.B-B2128	Cord reel	2.0 mm ² X 3C X 10m 14AWG X 3C X 33FT	100~120V	12A
H.C.B-C2128	Cord reel+110V work light	2.0 mm ² X 3C X 10m 14AWG X 3C X 33FT	100~120V	12A

規格：

- 風管可拉長至接近 3.3 呎
- ABS 外殼可防止撞擊 防撞 / 防鏽基座
- 符合 JIS 規格的銅材製造
- 電線和插座蓋安裝容易
- 三個插座，可供應三項電器使用
- 組裝容易 (只需螺絲起子即可組裝)
- 適用於商業、工業工作坊、維修廠和機械店
- 180°轉動的捲軸，可提供廣大工作範圍。也可以用 45°、90°和 135°角固定

H.C.B-D2128

WATER HOSE REEL (8 METERS)

水管捲揚器 (8 米)

4 / 22.8 / 26.3 / 4.27'

Specifications:

- ABS resin case, against impact
- Easy installation on the wall or the ceiling
- High impact and corrosion resistant base
- PVC water hose can bear up to 150 psi (10 bar)
- Suitable for commercial workspaces, industrial workspaces, automotive garages, and machine shops
- Free rotation within 180°, and can be installed at 45°, 90°, and 135° fixed angle
- Metal spray gun, heat and cold resistant

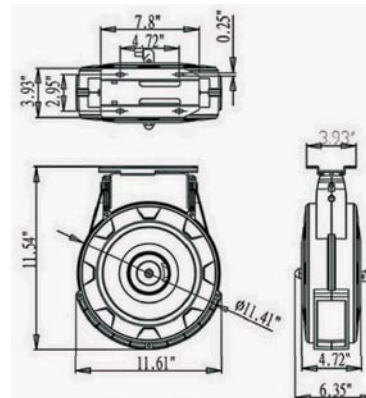

MODEL	NAME	SPECIFICATIONS	MAX PRESSURE
H.C.B-D2128	Water Hose Reel	Ø 7.5 mm x Ø 13 mm x Ø 8 M Ø 19/64" x Ø 33/64" x Ø 26ft	150 psi

規格：

- ABS 外殼可防止撞擊
- PVC 水管可耐受 150 psi (10 bar)
- 也可以用 45°、90°和 135°角固定
- 易於安裝牆上或屋頂上
- 適用於商業、工業工作坊、維修廠和機械店
- 金屬噴槍，耐熱又耐寒
- 防撞 / 防鏽基座
- 180°轉動的捲軸，可提供廣大工作範圍。

H.C.B-A1412

TRUCK RADIATOR PRESSURE TEST KIT (9 PCS)

卡車水箱測漏組 (9 PCS)

- Measuring range 10-15 psi
- Check on pressure loss through gauge
- Possibility of testing locking caps
- Pressure test on the cooling system

- 測試範圍：10-15 psi
- 透過壓力錶來檢測水箱各管路是否有漏水
- 符合各種車種的水箱蓋
- 適用於卡車水箱

1	Pressure Testing Pump with Gauge
2	Connecting
3	DEUTZ ENGINE(1015) MB-Sprinter(->2006),-(Vito-2006)
4	MAN-L 2000(1993-2000),-TGA(2000-), DAF-CF(2000-).
5	IVECO-LKW-Daily 2000 C-Serie. Renault-Kerax(1999-),-Magnum(1990-2003),-Midlum(2000-),-Premium(1997-)
6	MB-Actros(1997-),-Atego(1998-),-Axor(2001-),ECO 8401,LKW 1728, MAN-F90(1987-1996),-F2000(1995-2003),-E2000(2000-),TGA/L/M/S(2005), IVECO-EURO-Star(1993-2001),-EUROTech(1993-2001), EruoTruck,Eruo trakter(2002-),-Strahlis(2002-),-EUROCARGO(1991-),Euro Trakker Cursor(2002-),Euro Trakker Cursor 13(2001-)-DAF-LF55(2001-) Volvo-FM
7	DAF-XF 95(2002-2006),-XF 105(2005-), ERF-EC RANGE(1996-2003),
8	Volvo-FH 12
9	Scania-4 SERIES(1995-2004),-93,-94(1996-2004),-113,-114(1996-2004), -124(1996-2004),-125,-144(1996-2002),-164(1999-2004)



Optional(選購): A1412-12
For DAF (LF 45/55)
(EURO 4/5) (4期/5期)

H.C.B-A3005

10 TONS TWO SPEEDS DYNAMIC POWER KIT

10 噸雙段油壓鉸金組

- Quick "snap together" design for fast and easy assembly and disassembly.
 - Flexible hydraulic hose with spring guards at both ends.
 - Rugged & welding construction features its hand pump base is made by forging for resisting of oil leakage under collision & denting.
 - Components are also made by forging with the best rigidity and strength to ensure never broken during operation with high safety.
 - Each components are connected through female connector for easy operation.
- 快速接頭式設計，可迅速、簡便地組裝、拆解本工具組。
 - 彈性油壓管雙頭都附有保護彈簧。
 - 油壓缸以焊接方式和鍛造的底座連結，加強承載力。也可防止溢漏和塌陷。
 - 鍛造的零組件，可確保操作時的安全性。
 - 每個零組件都以母接頭連結，方便操作。



H.C.B-A1538

EXTRA LONG HEXAGON IMPACT WHEEL NUTS SOCKET (Dr. 3/4", 24/27/30/32/33/36 mm, L: 400 mm)

氣動長套筒 (Dr.3/4", 24/27/30/32/33/36 mm, L: 400 mm)

- Phosphate finish
- Chrome molybdenum
- Use for remover wheel nuts.



- 磷酸鋅處理
- 材質：鉻鉬鋼
- 此工具用於拆卸車輪螺母

Parts No.	Size	L(mm)	D1/D2(mm)
A1538-24	24	400	18/38.8
A1538-27	27	400	20/42.5
A1538-30	30	400	22/45.3
A1538-32	32	400	23/48.8
A1538-33	33	400	23/49.8
A1538-36	36	400	26/53.8

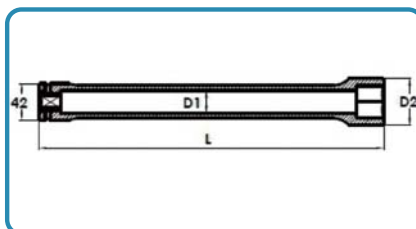

H.C.B-A1497

ALUM-A-STACK HYDRAULIC RAM KIT

卡車堆疊式油壓組

- Convenient kit allows you to select your ram length.
- 10 tons ram include 1"(2.5 cm), 2"(5 cm) and 3"(7.5 cm) extensions.
- Extensions can be used individually or joined
- Ships in carrying case.
- Weight : 4.3 kg
- Retracted height-3.5" (9 cm)
- Stroke length-1.5"(3.8 cm)



- 此工具可換接頭，加長，輕巧，使用更順手，省時又省力

H.C.B-A1543

NEW

CUMMINS TIMING TOOLS

康明斯正時工具組

- This Cummins barring tool is used to rotate the engine by inserting it into a port
- It provides an easy way to rotate the engine for valve adjustments or injection pump timing.
- Features a 1/2" female square drive.
- Cummins OEM No.ref:
3824591/4919663/4919107



- 此康明斯工具用於轉動引擎以正時。
- 此工具可用來旋轉引擎，或進行噴油幫浦的正時
- 尺寸：Dr.1/2
- 原廠號碼：3824591/4919663/
4919107

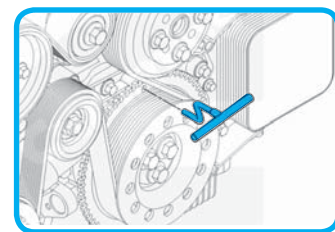
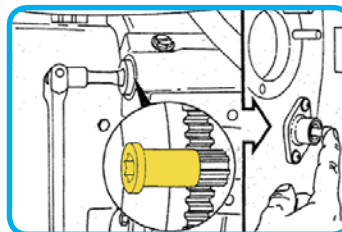

H.C.B-A1937

NEW

CYLINDER

油壓缸

- Capacity: 10~100 Tons
- Stroke: 38~62 mm
- Max. Working Pressure: 700 bar / 10,000 psi
- All cylinders are single acting with spring return.
- Pistons hard chromed.
- Cylinders inside roll-polished.
- Cylinders outside blasted with black nitriding finish.



- 適用：10~100 噸
- 行程：38~62 mm
- 最大工作壓力：700 bar / 10,000 psi
- 所有油壓缸都是單作用的彈簧復位。
- 內部滾動拋光的油壓缸。
- 外部油壓缸採用黑色氮化處理。

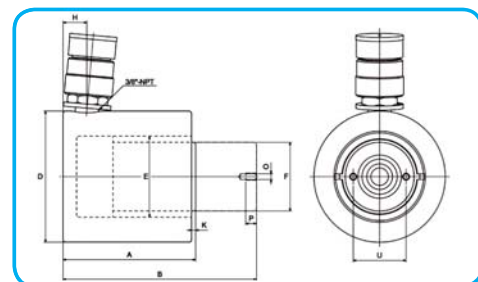

Model	Capacity (tons)	Stroke(mm)	Oil Cap (cm³)	A		E (Ø mm)	F (Ø mm)	H (Ø mm)	J (Ø mm)	K (Ø mm)	O (Ø mm)	P (Ø mm)	U (mm)	Weight
				Height(mm)	Retracted									
				A1937010	10									
A1937020	20	45	127.0	98	97	60	50.8	17.5	3	M5	9	39	5	
A1937030	30	62	274.0	117	107	75	63.5	19	3	M5	8	39	6.8	
A1937050	50	60.5	429.0	122	127	95	70	19	2	M5	8	39	10.9	
A1937100	100	58	830.0	141.5	165	135	92	19	1.5	M8	10	55	22.7	

H.C.B-A1936

NEW

CYLINDER

油壓缸

- Capacity: 5~150 Tons
- Stroke: 6~17 mm
- Max. Working Pressure: 700 bar / 10,000 psi
- All cylinders are single acting with spring return.
- Pistons hard chromed.
- Cylinders inside roll-polished.
- Cylinders outside blasted with black nitriding finish.
- 適用：5~150 噸
- 行程：6~17 mm
- 最大工作壓力：700 bar / 10,000 psi
- 所有油壓缸都是單作用的彈簧復位。
- 內部滾動拋光的油壓缸。
- 外部油壓缸採用黑色氮化處理。



Model	Capacity ton	Stroke (mm)	Oil Cap. (cm³)	A Height (mm)		C (Ø mm)	D (Ø mm)	E (Ø mm)	F (Ø mm)	H (Ø mm)	K (Ø mm)	V (Ø mm)	G (Ø mm)	L (mm)	M (mm)	Weight
				Retracted	Extended											
				A1936005	5											
A1936010	10	12	18.0	42	54	36.5	82.5x60	44	38	19	1	7.5	11	30	34	1.4
A1936020	20	12	34.0	51	63	49.3	100x78	60	50.8	19	1	10	15	39	39	3.1
A1936030	30	13	54.0	58	71	52.3	117.5x95	73	63.5	19	2	10	16	47.5	47.5	4.5
A1936050	50	16	113.0	66	82	66.5	145x115	95	70	19	2	11	19	57.5	58	6.8
A1936075	75	16	180.0	79	95	76.2	170x145	120	82.5	19	2	13.5	20.5	72.5	70	11.3
A1936100	100	16	229.0	85	101	76.2	185x160	135	92	19	2	13.5	20.5	80	78	14.5
A1936150	150	17	363.0	100	117	117	225x195	165	115	23	2	13.5	20.5	97.5	85	26.3

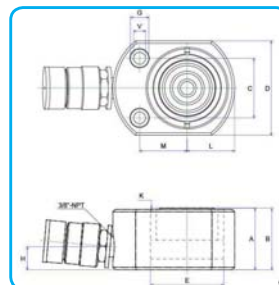

H.C.B-A1935

NEW

HOLLOW PLUNGER CYLINDER

中空油壓缸

- Capacity: 12~100 Tons
- Stroke: 8~155 mm
- Max. Working Pressure: 700 bar / 10,000 psi
- All cylinders are single acting with spring return.
- Pistons hard chromed.
- Cylinders inside roll-polished.
- Cylinders outside blasted with black nitriding finish.
- 適用：12~100 噸
- 行程：8~155 mm
- 最大工作壓力：700 bar / 10,000 psi
- 所有油壓缸都是單作用的彈簧復位。
- 內部滾動拋光的油壓缸。
- 外部油壓缸採用黑色氮化處理。

Model	Capacity ton	Stroke (mm)	Oil Cap. (cm³)	A Height (mm)		D (Ø mm)	E (Ø mm)	F (Ø mm)	H (Ø mm)	J (Ø mm)
				Retracted	Extended					
				A1935131	12					
A1935132	42	79	120	162		19				
A1935133	42	79	120	162		19				
A1935134	76	143.2	184	260		19				
A1935201	20	51	173	162	213	98.5	75	55	19	54
A1935202		155	527	306	461					
A1935301	30	65	310	178.5	243.5	117	90	65	21.5	59.9
A1935302		160	763	330	490					
A1935601	60	76	680	247.5	323.5	158.6	125	90	32	89
A1935602		152	1360	323.5	457.5					
A19351001	100	76	1085	254	330	213	165	125	38	125



Model	K (Ø mm)	O (Ø mm)	P (Ø mm)	U (Ø mm)	V (Ø UNC)	Z (Ø mm)	W (Ø mm)	X (Ø mm)	Y	Wight
									Centre hole (Ø mm)	
A1935131	-	3/4"-16	16	50.8	5/16"-18	9	23/4"-12	33	19.5	1.5
A1935132		-	-			12.7				3
A1935133		3/4"-16	16			12.7				3
A1935134		-	-			12.7				4.2
A1935201	7	19/16"-16	25	82.6	3/8"-16	9.4	37/8"-12	38	27	7.5
A1935202										13.5
A1935301	0.5	17/8"-16	25	92	3/8"-16	14	41/2"-12	42	34	11
A1935302										20.4
A1935601	12.5	23/4"-16	25	130	1/2"-13	14	61/4"-12	50	54	26.4
A1935602										34
A19351001	12	4"-16	30	178	5/8"-11	19	83/8"-12	60	79	50.1

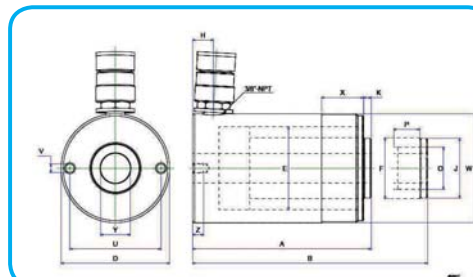

H.C.B-B1502

20 TONS AIR/HYDRAULIC TRUCK JACK-LOW TYPE

20 噸氣動 / 油壓千斤頂 (超低型)

- Professional use in repairing heavy duty truck, agricultural and heavy construction equipment.
- Ideal for loaded truck and trailer roadside service.
- Compact low profile design for maximum access, fit easily and safely between wheels of a tandem axle vehicle.
- "T" handle allows jack operation at any handle position.
- Handle locking lever secures handle in either vertical, horizontal or 45 degree position.
- Self-retracting ram eliminates manual lowering of jack.
- Quick rated capacities life using air actuated operation.
- Automatic by-pass mechanism protects user and hydraulic cylinder from over pumping danger.
- Rust in hibitive coating on ram and extension screw.
- Extension screw gives added height when necessary.



Model	Capacity(Ton)	Stroke(mm)	Min. Height(mm)	Max. Height(mm)	Ext. Bar(A)mm	Ext.Bar(B)mm	Ext.Bar(C)mm	LxWxH(mm)	Weight(kgs)
B1502	20	90	190	280	15	40	60	570x140x1100	29

H.C.B-C1502

50 TONS AIR/HYDRAULIC JACK

50 噸 氣動 / 油壓千斤頂

- Low profile design for most of industrial applications.
- Forging base as the strongest construction to catch the needs in industry market.
- Housing welding onto the forged base makes to be free of leakage problem as well.
- Telescopic design of C1502 reaches the extra needed during operating to save time and labor cost much.
- The equipped with two large Dia. Rubber wheels provide the greatest convenience and mobility you need.
- Air / Hydraulic design make you free pumping handle also with the most efficiency and time saving.



Model	Capacity (Ton)	Stroke (mm)	Min.Height (mm)	Max. Height (mm)	Ext. Bar(A) mm	Ext. Bar(B) mm	Ext. Bar(C) mm	L x W x H (mm)	Weight (kgs)
C1502	20	90	190	280	15	40	60	570x140x1100	29

H.C.B-A1481

VOLVO/ HINO REMOVAL TOOL FOR OIL FILTER (Dr. 1/2") (100-110 mm)

VOLVO /HINO 機油芯 / 油水分離器濾芯扳手 (Dr. 1/2") (100-110 mm)

H.C.B-B1481

FUSO (10.5-17 TONS) REMOVAL TOOL FOR OIL FILTER (Dr. 1/2") (110-125 mm)

FUSO (10.5-17 噸) 機油濾芯 / 油水分離器濾芯扳手 (Dr. 1/2") (110-125 mm)

H.C.B-C1481

DAF/MAN/SCANIA REMOVAL TOOL FOR AIR DRYER FILTER (Dr. 1/2") (125-140 mm)

DAF/MAN/SCANIA 四向閥乾燥濾芯扳手 (Dr. 1/2") (125-140mm)

H.C.B-D1481

SCANIA REMOVAL TOOL FOR FUEL FILTER (Dr. 1/2") (70-80 mm)

SCANIA 柴油濾芯扳手 (Dr. 1/2") (70- 80 mm)

H.C.B-E1481

TRUCK REMOVAL TOOL FOR FUEL FILTER/ OIL FILTER (80-90 mm)

卡車柴油 / 機油濾芯扳手 (80-90 mm)

H.C.B-F1481

EUROPEAN/JAPANESE TRUCK REMOVAL TOOL FOR FUEL FILTER/OIL FILTER (90-100 mm)

歐 / 日系卡車柴油 / 機油濾芯扳手 (90-100 mm)

- Drain the engine oil into suitable container and clean around the oil filter housing. Remove the filters, using filter tool A1481.
- OEM number:9996672
- 旋開油水分離器下部的放水閥放掉燃油。拔掉預熱插頭，再用濾清器扳手拆掉濾清器。
- 原廠號碼：9996672



編號 ITEM NO.	尺 SIZE(mm)	適用車種 Application
A1481	100-110 mm	VOLVO/ HINO 6.5,7.5,8(tons)OIL FILTER VOLVO/ HINO 6.5,7.5,8(tons) 機油濾芯 RENAULT (450) OIL FILTER RENAULT (450) 機油濾芯 SCANIA OIL FILTER SCANIA 機油濾芯
B1481	110-125 mm	FUSO 10.5-17(tons) OIL FILTER FUSO 10.5-17(tons) 機油濾芯
C1481	125-140 mm	MAN/ SCANIA/ DAF Air Dryer Filter MAN/ SCANIA/ DAF 四向閥乾燥濾芯
D1481	70-80 mm	SCANIA FUEL FILTER SCANIA 柴油濾芯
E1481	80-90 mm	TRUCK 卡車
F1481	90-100 mm	FUSO (320) Oil Filter FUSO (320) 機油濾芯 SCANIA (113) Oil Filter SCANIA (113) 機油濾芯 SCANIA (114) Fuel Filter SCANIA (114) 柴油濾芯 SCANIA (SD) Transmission Filter SCANIA (SD) 變速箱濾芯

H.C.B-A1560**SCANIA 113 (320) TRUCK FRONT WHEEL AXLE BEARING PULLER**

SCANIA 113(320) 卡車前輪軸培林拔卸器

- This tool has two accessories of bearing block. When using different accessory, it can use on SCANIA 113 (320) trucks. It can save your time and labor when you remove the bearing from the front shaft axle.
- 此工具有兩種培林套座配件，可依照不同需求，使用在歐系車上，使用此工具，讓您在拔除培林時，更省時、省力。

**H.C.B-B1560****TRUCK FRONT WHEEL AXLE BEARING PULLER AXLE (JAPANESE TRUCK)**

卡車前輪軸培林拔卸器 (日系車種)

- This tool has three accessories of bearing block. When using different accessory, it can use on Japanese trucks. It can save your time and labor when you remove the bearing from the front shaft axle.
- 此工具有三種培林套座配件，可依照不同需求，使用在日系車上，使用此工具，讓您在拔除培林時，更省時、省力。



VIDEO

**H.C.B-D1560****TRUCK REAR WHEEL AXLE BEARING PULLER (JAPANESE TRUCK)**

卡車後輪軸培林拔卸器 (日系車種)

- This tool is used for the extraction of the flank bearing of rear wheel axle of Japanese truck.
- Application: HINO, UD, ISUZU, FUSO (Over 17 tons)
- Bearing no.: 32217/32218
- 說明：此工具用來拔除日系卡車後輪軸內側培林
- 適用車種：HINO, UD, ISUZU, FUSO 17 噸以上卡車
- 培林編號：32217/32218



VIDEO



H.C.B-C1560

TRUCK FRONT WHEEL AXLE BEARING PULLER (SCANIA/JAPANESE TRUCK)

卡車前輪軸培林拔卸器 (SCANIA/ 日系車種)

- This tool has five accessories of bearing block. When using different accessory, it can use on European and Japanese trucks. It can save your time and labor when you remove the bearing from the front shaft axle.
- 此工具有五種培林套座配件，可依照不同需求，使用在歐系與日系車上，使用此工具，讓您在拔除培林時，更省時、省力。

Part No.	Truck type	Bearing no.	Applicable
5	European (歐系)	T2EE060	SCANIA 113(320) Small axle shaft
6		BT1-0554A (32312)	SCANIA 113(320) Big axle shaft
7	Japanese (日系)	32313JR 30313JR	HINO over 15 ton ISUZU(Big)over 15 ton UD 520 380
8		ET-CR-1355	FUSO 15-35 ton 320 350
9		ET-CR-1364	FUSO 330 355
10 (Optional)		3031-OJR	HINO 8.8~11 ton
11 (Optional)		55KW02	FUSO 11 ton
12 (Optional)			
13 (Optional)	Japanese (日系)	32310U	HINO 10.5 ton
14 (Optional)	European (歐系)	3319331Q	MAN 410, 414, 422
15 (Optional)	China (大陸)	X32311	SC112 Sangyang-Kinglong Bus
16 (Optional)	China (大陸)	32314U	BEIBEN bus
17 (Optional)			
18 (Optional)			



H.C.B-A1853

NEW

HEAVY DUTY GEARBOX BEARING PULLER PAT.

大型變速箱培林拔卸器

- Easy to use: Put the jaws into the inner hole of the bearing, and use hand to turn the knob of expander in the middle, so the jaw can expand and hook onto the bearing. Finally, turn the central spindle to pull out the bearing
- Application: DAF CF65 LF55 17TONS/VOLVO.
- 使用方式：將三爪放入培林內後，轉動上方螺絲讓三爪向外張開勾住培林，再繼續轉動直到培林拆卸完成。
- 適用車種：DAF CF65 LF55 17TONS/VOLVO.



Diameter: 65-120 mm



Diameter: 100-165 mm

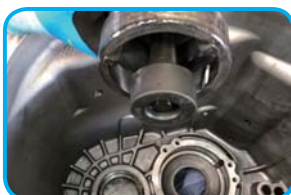
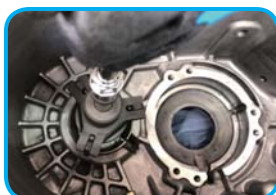

VIDEO



H.C.B-E1560

SCANIA (113/114), MAN (410/414) TRUCK DIFFERENTIAL MAIN SHAFT BEARING EXTRACTOR

SCANIA (113/114), MAN (410/414) 卡車差速器主軸培林拆卸器

- Instruction: Normally, the removal of bearing is done by cutting, but it'll cause the damage of main shaft. Using this tool kit makes the removal of bearing done quickly, safely, and prevents the bearing from damage.
- Applications: SCANIA (113/114), MAN (410/414)
- 說明：傳統使用切割的方式拔除培林，易損壞到主軸。使用此工具在拔除差速器的培林，能快速、安全，並保護培林不受損壞。
- 適用車種：SCANIA (113/114)(R770/R780), MAN (410/414)



VIDEO



H.C.B-G1560

FUSO (330) TRUCK DIFFERENTIAL MAIN SHAFT BEARING EXTRACTOR

FUSO (330) 卡車差速器主軸培林拆卸器

- Feature:
- Normally, the removal of bearing is done by cutting, but it'll cause the damage of main shaft. Using this tool kit can make the removal of bearing done quickly, safely, and prevent the bearing from damage.
 - Application: FUSO (330) truck

特色：

- 此工具有五種不同培林套座配件，可依照不同需求，使用在日系車上，使用此工具，讓您在拔除培林時，更省時、省力
- 適用車種：FUSO (330) 卡車



H.C.B-A2280

UNIVERSAL JOINT (Dr. 1")

1" 萬向轉接頭

- Drop-forged steel universal joint.
- Suitable for use on all types of air impact tool.
- Chrome Molybdenum steel with phosphate finish for added corrosion resistance.
- Spring-ball socket retainer and drilled head to accept retaining pin.
- 落鍛萬向轉接頭。
- 適用於所有氣動工具。
- 鉻鉬鋼，用磷酸鹽光潔度以增加耐腐蝕性。





H.C.B-A2282

TRUCK BRAKE SPOONS (2 PCS)

卡車剎車調整扳手 (2 PCS)

- Full length: 16/18*200 mm
- Designed to adjust brakes on most cars and light trucks.
- Universal angle design for most cars.

- 全長：16/18*200 mm
- 此工具設計用來調整一般車及輕型卡車剎車
- 萬用角度設計可用於大部分車種



H.C.B-A1893

NEW

SITRAK OIL SEAL REMOVER

賽德卡油封拆卸工具

- To prevent the oil seal from damaged when removing it.
- Application: Sitrak

- 使用此工具在拆卸油封時，可避免傷害到汽車零件
- 適用車種：賽德卡卡車



H.C.B-A1894

NEW

SITRAK OIL SEAL INSTALLER

賽德卡油封安裝工具

- To prevent the oil seal from damaged when installing it.
- Application: Sitrak

- 使用此工具在安裝油封時，可避免傷害到汽車零件
- 適用車種：賽德卡卡車



H.C.B-A2258

TOE JACK

L 型油壓千斤頂

- Heat treated & chrome plated hydraulic rod provide longer seal life and optimum performance.
- Housing welding onto the forged base makes to be free of leakage problem.
- Removable handle saves the handle force during operation.
- High strength Toe-Lift in tight clearances.
- Use the safe dependable toe jacks and speed rollers to safely lift and move a heavy load in a low clearance situation.
- Super low height (the lowest in the industry) toe jacks, ease operation under the most difficult situations.
- These are the best choice for lifting heavy machinery and cargo, especially when installing industrial machinery.

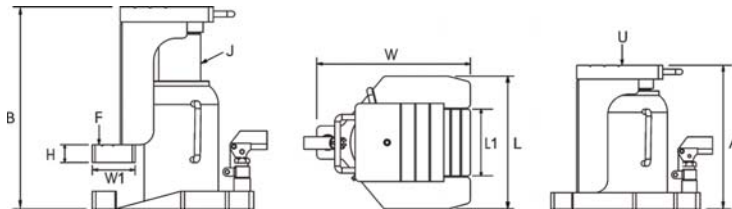

Item	TOP CAP. U(Tons)	TOP-LIFT CAP. F(Tons)	TOE-LIFT STROKE (mm)	MIN. HEIGHT A(mm)	MAX. HEIGHT B(mm)	PISTON ROD DIA. J(mm)	BASE DIMENSIONS LxW(mm)	HEIGHT H(mm)	TOP-LIFT L1xW1(mm)
A2258-025	2.5	1.2	70	194	294	19	140 X 190	19	65 X 50
A2258-040	4	2	80	204	314	25	150 X 200	19	65 X 50
A2258-060	6	3	80	212	322	36	160 X 217	19	65 X 50
A2258-100	10	5	100	258	388	40	189 X 242	22	75 X 55
A2258-160	16	8	100	275	406	52	211 X 256	25	90 X 55
A2258-200	20	10	90	303	443	56	228 X 274	25	100 X 60
A2258-300	30	15	80	322	469	70	259 X 305	32	110 X 60
A2258-500	50	25	80	333	481	90	299 X 347	38	150 X 60

H.C.B-A2273

TRUCK CLUTCH AND FLYWHEEL JACK-LOW CLEARANCE

卡車離合器 / 飛輪千斤頂

- To remove, install and transport (in the lowered position) both 14" & 15-1/2" heavy duty clutches and flywheel.
- Clutch removal and installation becomes a one-man job.
- Adjustment bolt on saddle aligns clutch.
- Spline shaft rotates 360 degrees, turns left and right for clutch and engine alignment. 2" and 1-3/4" spline shafts included.
- Conveniently located release valve and 360 degree rotating pump handle allow jack to be operated in any work position.



- 用來拆卸、安裝和運輸 (在較低的位置) 這兩個 14" 及 15-1/2" 重型離合器和飛輪。
- 離合器的拆卸和安裝只需要一個人工作即可。
- 在調整螺栓對齊離合器。
- 軸旋轉 360 度，轉左、右離合器和發動機對齊。2" 和 1-3/4" 軸包含在內。
- 便利釋放閥和 360 度旋轉幫浦手柄使千斤頂在任何位置進行操作。

H.C.B-A2281

Dr. 3/4" IMPACT SOCKET KIT (17 PCS)
(19/21/22/24/27/30/32/33/34/35/36/38/40/41/46/50/55 mm)

Dr. 3/4" 氣動套筒組 (17 PCS)
(19/21/22/24/27/30/32/33/34/35/36/38/40/41/46/50/55 mm)

- Material Surface Finish: CR-MO, Black phosphate
- Size:
19/21/22/24/27/30/32/33/34/35/36/38/40/41/46/50/55 mm
- 表面處理 : CR-MO
- 尺寸 :
19/21/22/24/27/30/32/33/34/35/36/38/40/41/46/50/55 mm



H.C.B-C2297

DIESEL/ PETROL FUEL SYRINGE (1.5 L)

柴 / 汽油真空抽取注射器 (1.5 升)

- 1.5 liters
- Designed for both petrol and diesel vehicles, to retrieve excess fuel from fuel lines before maintenance.
- Eliminates the risk of fuel spills and damage to pipes, if clamped.
- Connectors for PSA/Vauxhall/Opel vehicles and two universal connectors for older cars.
- Prevents spillage
- Adaptor Universal
- 容量 : 1.5 升
- 此注射器適用於汽柴油車種，於維修前，可將油管內多餘的油抽出。
- 此注射器具特殊設計可防油料溢出且不會損傷油管。
- 配有 PSA/Vauxhall/Opel 車種的接頭及兩種廣用接頭可適用於舊式車種。
- 廣用型轉接頭



H.C.B-A2299

3 FUNCTION TIRE PRESSURE GAUGE (FOR TRUCK)

三用胎壓量錶 (卡車)

- The professional choice of dial pressure gauge for quick, clear and accurate readings.
- 專業壓力表，可以快速、清晰的測出胎壓



H.C.B-A2300

FLEXIBLE CROW'S FOOT SOCKET WRENCH KIT (12 PCS)

搖頭鴨掌扳手組 (12 PCS)

- 3/8" square drive rotatable head wrenches.
- Sizes: 8, 9, 10, 11, 12, 13, 14, 15, 16, 17, 18 & 19 mm
- Rotatable head which can rotate 230 degrees
- Traditional flare nut wrench with crowfoot function.
- Used with F-bar, H-bar, T-bar, speed-handle
- A rotatable crowfoot wrench can be used in hard-to-reach areas with the limit of 110 degrees
- Suitable for all hydraulic, fuel, oil brake, A/C, O2 sensor and air line work



- Dr. 3/8" 的活動扳手
- 尺寸：8, 9, 10, 11, 12, 13, 14, 15, 16, 17, 18 & 19 mm
- 旋轉角度可達 230 度
- 結合傳統的錐型扳手及鴨掌扳手的功能
- 結合 F 型, H 型, T 型的搖頭鴨掌扳手
- 使用搖頭鴨掌扳手時，可使用在一般扳手難以使用的地方，其中角度可達 110 度
- 適用於所有的油壓、氣油、剎車油、冷氣、氧氣感應器和航空作業

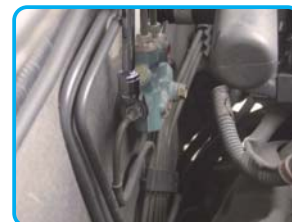

H.C.B-A2301

75° BOX END & FLEXIBLE GEAR RATCHET WRENCH WITH GO-THROUGH SOCKET KIT (17 PCS)

穿透式套筒組 (17 PCS)

- Specification:
- 1PCS - 20 mm 75° Box end & flexible gear ratchet wrench with go-through socket wrench handle
- 1PCS - 20 mm × 75 mm (L) Go-through extension bar
- 12PCS - Go-through sockets: 8, 9, 10, 11, 12, 13, 14, 15, 16, 17, 18 & 19 mm
- 1PCS - 20 mm × 1/4" Socket adaptor
- 1PCS - 20 mm × 3/8" Socket adaptor
- 1PCS - 20 mm × 1/2" Socket adaptor



- 規格
- 1PCS - 20 mm 尾端具有 75 度穿透式扳手的可轉動式棘輪扳手。
- 1PCS - 20 mm × 75 mm (L) 穿透式延長桿
- 12PCS - 穿透式套筒：8, 9, 10, 11, 12, 13, 14, 15, 16, 17, 18 & 19 mm
- 1PCS - 20 mm × 1/4" 套筒接頭
- 1PCS - 20 mm × 3/8" 套筒接頭
- 1PCS - 20 mm × 1/2" 套筒接頭



H.C.B-A2302

DOUBLE FLEXIBLE RATCHET FLARE NUT WRENCH (10 x 12 /13 x 14/15 x 17 mm) (3 PCS)

雙搖頭開口油管扳手 (10 x 12 /13 x 14/15 x 17 mm) (3 PCS)

- This product is upgraded version of a traditional long pipe wrench which becomes a ratchet pipe wrench that can be used in the brake line, and the small space such as small-angle ABS, EBD, EBC, ESP, etc. In active safety technology.
- The head of this wrench can rotate 180 degrees.
- Color marking buckles, red is forward, black is reversal.
- Car: This size is a common size, which is suitable for various types of vehicles.
- The size of brake systems: 8/10/11/12; The fuel lines with the size: 13/14/15/17
- Mid-size species, large vehicles will become larger.
- 此產品有別於一般傳統的長的扳手，新型的棘輪扳手可以在於煞車線與空間較小的地方。例如角度較小的 ABS、EBD、EBC、ESP 等主動安全系統
- 扳手前端可 180 度旋轉
- 使用顏色進行辨識，紅色為順時針旋轉，黑色為逆時針旋轉
- 煞車系統的尺寸為 8/10/11/12; 氣油管線的尺寸為 13/14/15/17
- 可適用於中型與大型車種



H.C.B-A2348

NEW

Dr. 3/4" TORQUE WRENCH (140~760N.M / 100~560 FT-LB)

扭力扳手 (Dr.3/4", 140~760N.M)

Features:

- Industrial application with durability.
- Single drive design for applying to clockwise direction; both push & no-push are available for selection.
- Lightweight yet robust; housing is made of aluminium alloy.
- Loud click sound and strong impulse when torque value reached.
- Tolerance of torque $\pm 3\%$.
- Quality meets DIN ISO 678 & ASME B107.300-2010.

特色：

- 可應用在工業用途
- 驅動設計可順時針與逆時針方向，有 "Push" 和 "No-Push" 可選擇
- 輕巧且堅固，外殼是由鋁合金製成
- 當此工具達到最大扭力值時，會有 "喀噠" 聲響
- 扭矩公差 $\pm 3\%$ 。
- 符合 DIN ISO 678 和 ASME B107.300-2010 標準



H.C.B-A2306

Dr. 3/4" TORQUE WRENCH (200-1000 N.M)

Dr. 3/4" 扭力扳手 (200-1000 牛頓米)



- Industrial application.
- Wide range of choice.
- Tolerance of torque $\pm 3\%$.
- Easy torque-adjusting design brings energy-saving benefit.
- Applied to both clockwise and counterclockwise directions.
- Quality meets DIN ISO 6789 & ASME B107.300-2010.
- 可應用在工業範圍
- 可選擇的範圍寬廣
- 扭力誤差值： $\pm 3\%$
- 簡易好操作的設計為你節省時間
- 可順時針使用也可逆時針使用
- 品質符合 DIN ISO 6789 & ASME B107.300-2010.

H.C.B-A2307

RATCHET EXHAUST PIPE CUTTER

排氣管切管器

- Universal application pipe cutter designed for where access is restricted.
- Ratchet mechanism allows cutting without having to rotate the tool completely around the tubing.
- Suitable for the toughest materials including stainless steel exhaust pipes.
- Contents : 1" 7/32 \rightarrow 2" 9/16", 31-65 mm, thickness ≤ 3 mm
- 通用型的切管設計
- 棘輪式的切管設計讓切割時不用繞著管線旋轉即可輕鬆切管
- 適用在難以切割的材質，包括不銹鋼排氣管



H.C.B-A2309

3L TRUCK/ TRAILER WHEEL AXLE OIL DRAIN

3L 卡車 / 拖車輪軸油盤

- Contents:
Capacity: 3 L (107 oz)
Weight: 380 – 400 g
Dimension of product: 316 (L) \times 246 (D) \times 156 (H) mm
- Features & Benefits:
Ideal for using during truck & trailer wheel repair.
It has features like easy pour evacuation mouth & ergonomic handles with storage capability for hub nuts.
Used to catch oil from wheel hubs after removing cap.
- 規格
容量：3 升 (107 盎司)
重量：380 – 400 g
尺寸：316 (長度) \times 246 (深度) \times 156 (高度) mm
- 此為卡車及拖車輪胎維修的理想工具。
- 具有可以輕鬆傾倒排油的開口設計及符合人體工學且具收納輪殼螺帽設計的把手。
- 在移除輪圈蓋後，此油盤可以用來接取從輪殼流下來的油。



H.C.B-A2310

OIL DRAIN PAN

油盤

Features & Benefits:

- This oil drain pan includes easy grip, large carrying handles and integral spout for pouring waste oil or fluids into a recycling container.
- The anti-splash lip prevents spillage. Ideal for draining antifreeze or oil.

※Not suitable for spray gun cleaner



特色 & 優點:

- 此油盤擁有方便、好拿取的大提把和方便傾倒廢油、廢液的集中型漏斗嘴。
- 漏斗嘴有防潑濺設計，可避免液體溢出，是用來收集防凍劑或廢油的理想容器。

※ 請勿使用噴槍清洗

Contents:

Item no.	Capacity	Weight	Dimension of product
A2310-035	3.5 L	284 g	410 (L) x 330 (D) x 100 (H) mm
A2310-080	8 L	566 g	502 (L) x 400 (D) x 132 (H) mm
A2310-160	16 L	952 g	582 (L) x 472 (D) x 156 (H) mm

H.C.B-A1767

NEW

AIR TUBING ADAPTOR CLAMP

風管管束鉗

- Choose the appropriate clamp to fix the hose, then use the pliers install the adaptor into the hose.
- Applicable size: Ø 6mm, Ø9 mm, Ø12 mm, Ø14 mm, Ø18mm
- 此工具可固定鉗固定住風管，以將接頭裝入風管
- 適用尺寸：Ø 6mm, Ø9 mm, Ø12 mm, Ø14 mm, Ø18mm



H.C.B-B1767

NEW

AIR TUBING ADAPTOR INSTALLATION TOOL KIT

風管接頭安裝工具組

- Choose the appropriate clamp to fix the hose, then use the pliers install the adaptor into the hose.
- Applicable size: Ø 6mm, Ø9 mm, Ø12 mm, Ø14 mm, Ø18mm
- 選擇適合的固定鉗固定住風管後，再使用夾具將接頭裝入管內
- 適用尺寸：Ø 6mm, Ø9 mm, Ø12 mm, Ø14 mm, Ø18mm



H.C.B-A1837

NEW

GENERAL ENGINE MAINTENANCE HANDLING TOOL

通用引擎維修搬運工具

- Instruction: After the service technician removed the engine, the A1837 can be used to secure the engine that engineer can easily service any part of the engine. Without this tool, the engineer spends a lot of time servicing the engine.
- Application: V6,V8,V10,V12 engine

- 使用說明：當維修人員拆卸引擎以後，可以使用 A1837 工具將引擎固定，讓維修人員能更輕鬆的維修引擎的任何部分。底部特別加上木材板條，增加與貼處面的摩擦阻力，讓維修人員在搬運 A1837 過程時，不會因外在因素而晃動，確保引擎穩固的固定在 A1837 上。
- 適用車種：V6.V8.V10.V12 引擎



H.C.B-C1475

NEW

HIGH PRESSURE FUEL LINE SOCKET
(Dr. 3/8" x 19 mm x 78 mm L)

高壓油管套筒 (Dr. 3/8" x 19 mm x 78 mm L)

- Universally suitable for the coupling nut of the high pressure fuel line of passenger cars and trucks.
- Specially cut-socket (19 mm) for quick and easy loosening and tightening the union nut at high pressure lines of common rail diesel engines.

- 此套筒適用多數汽車或卡車的高壓油管接頭。
- 特殊切削之外型設計 (19 mm)，於拆裝高壓油管接頭時，更輕鬆、快速

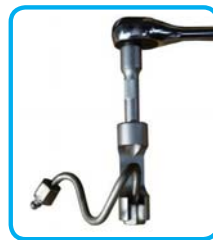

H.C.B-D1475

NEW

HIGH PRESSURE FUEL LINE SOCKET
(Dr. 3/8" x 21 mm x 78 mm L)

高壓油管套筒 (Dr. 3/8" x 21mm x 78 mm L)

- Universally suitable for the coupling nut of the high pressure fuel line of passenger cars and trucks, such as DAF XF/ CF with Euro 6, MX11/ MX13 engine.
- Specially cut-socket (21 mm) for quick and easy loosening and tightening the union nut at high pressure lines of common rail diesel engines.

- 此套筒適用多數汽車或卡車的高壓油管接頭，如搭載六期 MX11/ MX13 引擎之 DAF XF/ CF 卡車。
- 特殊切削之外型設計 (21 mm)，於拆裝高壓油管接頭時，更輕鬆、快速。

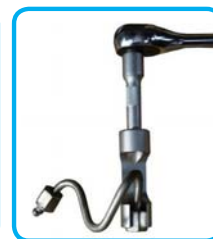
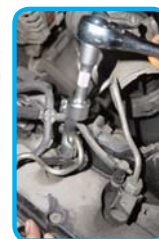

H.C.B-A1851

NEW

SOCKET DISPLAY STAND

套筒展示架

- This socket display stand can tidily display all the sockets which makes it easier and saves time to look for any socket.
- 此展示架可將套筒有系統的整齊排列，維修時，不用浪費時間到處尋找套筒，省時又美觀。



General Truck
Repair Tool

H.C.B-A2334

NEW

PROFESSIONAL EXTENDABLE HANDLE RATCHET WRENCH (72 TEETH)

72 齒免撥伸縮葫蘆柄扳手

- Just turn the handle to switch the gear direction in a blink. (No need to stop and turn the switch to change the gear direction.)
- Push down the collar to extend the handle.



VIDEO

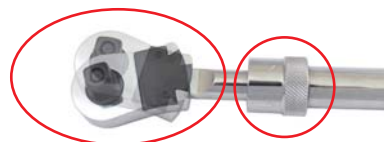

ITEM no.	Description	Length
A2334-0104	1/4" Dr. Professional Extendable Handle Ratchet Wrench 72 teeth.	151.5/176.5/201.5 mm
A2334-0308	3/8" Dr. Professional Extendable Handle Ratchet Wrench 72 teeth.	238/266/294/322/350 mm
A2334-0102	1/2" Dr. Professional Extendable Handle Ratchet Wrench 72 teeth.	304/332/360/388/416/444 mm

H.C.B-B2334

NEW

PROFESSIONAL EXTENDABLE HANDLE RATCHET WRENCH (60 TEETH)

60 齒免撥伸縮葫蘆柄扳手

- Just turn the handle to switch the gear direction in a blink. (No need to stop and turn the switch to change the gear direction.)
- Push down the collar to extend the handle.
- 只需轉動扳手，即可變換棘輪方向。(無須停下、轉動旋鈕更換棘輪方向。)
- 將把手上的固定環向下推，即可調整把手長度。



H.C.B-A2336

NEW

1/2" F X 3/4" M 1500NM TORQUE MULTIPLIER KIT (7 PCS)

1500NM 9 倍倍力器組 (7 PCS)

- Torque multiplier can turn small amounts of input torque into large output torque to loosen the toughest threaded fasteners which increase the efficiency and save labor.

- Specification:

Dr. 1/2" F. × Dr. 3/4" M.

Gear ratio: 1:9

Torque Ratio: 1 : 6.5

Max. Input Torque: 231 Nm (170 lb-ft)

Max. Output Torque: 1500 Nm (1106 lb-ft)

Torque Multiplier × 1 pcs, 380mm Reaction Bar × 1 pcs

90° Reaction Bar × 1 pcs, 90° Reaction Base × 1 pcs

Break-Away Adapter × 2 pcs, L Type Hex Key × 1 pcs

Input drive: Dr. 1/2" female

Output drive: Dr. 3/4" male

- 扭力倍力器可以將輸入的小扭力，放大成大扭力，如遇到難以鬆開的螺母，此工具可以讓使用者以更少的力氣鬆開螺母，以達到省時、省力。

- 規格：

Dr. 1/2" F. × Dr. 3/4" M.

齒比：1:9

扭矩比：1：6.5

最大輸入扭力：231 Nm (170 lb-ft)

最大輸出扭力：1500 Nm (1106 lb-ft)

扭力倍力器 × 1 pcs、380 mm 支撐桿 × 1 pcs

90° 支撐桿 × 1 pcs、90° 支撐座 × 1 pcs

防爆接頭 × 2 pcs、六角 L 扳手 × 1 pcs

輸入方樺：Dr. 1/2" 母

輸出方樺：Dr. 3/4" 公

Do not use with impact tool!
※ 不能與氣動工具一起使用！

H.C.B-B2336

NEW

3/4" F X 1" M 2500NM TORQUE MULTIPLIER KIT (7 PCS)

2500NM 4 倍倍力器組 (7 PCS)

- Torque multiplier can turn small amounts of input torque into large output torque to loosen the toughest threaded fasteners which increase the efficiency and save labor.

- Specification:

Dr. 3/4" F. × Dr. 1" M.

Gear ratio: 1:4

Torque Ratio: 1 : 3.3

Max. Input Torque: 758 Nm (559 lb-ft)

Max. Output Torque: 2500 Nm (1850 lb-ft)

Torque Multiplier × 1 pcs, 380mm Reaction Bar × 1 pcs

90° Reaction Bar × 1 pcs, 90° Reaction Base × 1 pcs

Break-Away Adapter × 2 pcs, L Type Hex Key × 1 pcs

Input drive: Dr. 3/4" female

Output drive: Dr. 1" male

- 扭力倍力器可以將輸入的小扭力，放大成大扭力，如遇到難以鬆開的螺母，此工具可以讓使用者以更少的力氣鬆開螺母，以達到省時、省力。

- 規格：

Dr. 3/4" F. × Dr. 1" M.

齒比：1:4

扭矩比：1：3.3

最大輸入扭力：758 Nm (559 lb-ft)

最大輸出扭力：2500 Nm (1850 lb-ft)

扭力倍力器 × 1 pcs、380 mm 支撐桿 × 1 pcs

90° 支撐桿 × 1 pcs、90° 支撐座 × 1 pcs

防爆接頭 × 2 pcs、六角 L 扳手 × 1 pcs

輸入方樺：Dr. 3/4" 母

輸出方樺：Dr. 1" 公

Do not use with impact tool!
※ 不能與氣動工具一起使用！

H.C.B-A2333

NEW

TRUCK CLUTCH ALIGNER TOOL (6 PCS)

卡車離合器校正工具 (6 PCS)

- For trucks with single or double disc clutches (universal)
- This tool set allows the correct alignment of single or double disc clutches of trucks and tractors to the engine.
- Mandrel NO.1 is applicable on interior clutch hub- \varnothing from 36-45mm inside.
- Mandrel NO.2 is applicable on interior clutch hub- \varnothing from 42-52mm inside.
- The clutch aligner kit contains centering sleeves with \varnothing 20, 25, 27 and 30mm.



- 單離合器與雙離合器都適用。
- 此工具可協助安裝單離合或雙離合卡車、耕耘機的離合器。
- 1 號適用在內徑 \varnothing 36 – 45 mm 的離合器
- 2 號適用在內徑 \varnothing 42 – 52 mm 的離合器
- 此校正工具包含 \varnothing 20、25、27 和 30 mm 的接頭。

H.C.B-A2340

NEW

6 TONS JACK STANDS

6 噸頂車架

- Ratcheting safety design ensures stands will remain locked even under the heaviest loads.
- Convenient handles are mounted to frame and column release.
- Specifications:
Min. Height (mm): 390
Max. Height (mm): 605
Base Dimensions: 10-13/16" x 9-7/16"
- 齒式的安全設計，即便是在最大的負重下，依然可確保頂車架牢牢固定住，不會突然下墜。
- 頂車架上有順手的把手，可以輕鬆的調整高度。
- 規格：
最低高度 (mm): 390
最高高度 (mm): 605
底座尺寸：10-13/16"x 9-7/16"



H.C.B-A2341

NEW

2.5 TONS HYDRAULIC TROLLEY JACK

2.5 噸油壓千斤頂

- 360 degree swivel casters, and safety overload system to prevent use beyond rated capacity.
- Rotating heavy duty saddle, 360 degree handle for use at any angle.
- Light weight jack for easy transport.
- Specifications : Min. Height (mm): 75 mm
Max. Height (mm): 515 mm
- 配有可 360 度旋轉的轉輪及安全防過載系統，可避免使用超過其最大負載力。
- 旋轉式頂座可 360 度旋轉，以便於任何角度使用。
- 輕型千斤頂，非常方便攜帶。
- 規格：最低高度 (mm): 75 mm 最高高度 (mm): 515 mm



H.C.B-A2342

NEW

2.5 TONS HYDRAULIC FLOOR JACK

2.5 噸油壓千斤頂

- 360 degree swivel casters, and safety overload system to prevent use beyond rated capacity.
- Rotating heavy duty saddle, 360 degree handle for use at any angle.
- Specifications : Min. Height (mm): 135 mm
Max. Height (mm): 520 mm



- 配有可 360 度旋轉的轉輪及安全防過載系統，可避免使用超過其最大負載力。
- 旋轉式頂座可 360 度旋轉，以便於任何角度使用。
- 規格：最低高度 (mm): 135 mm 最高高度 (mm): 520 mm

H.C.B-A2343

NEW

2 TONS ALUMINUM RACING JACK

2 噸鋁合金千斤頂

- High strength ultra light aluminum for easy maneuverability.
- Double pump design rapidly raises jack to maximum height with fewer strokes.
- Side mounted handles for easy lifting and carrying.
- Wiper seals protect hydraulic system from contaminants.
- Overload and by-pass safety valves prevent use beyond the jacks rated capacity and over extension of the ram.
- Removable rubber saddle protects vehicle and prevents slipping.
- Universal design release mechanism provides safe, controllable lowering of the vehicle.
- Suitable for clearance is an issue - super low profile at only 95mm!
- Specifications :
Min. Height (mm): 95 mm
Max. Height (mm): 440 mm

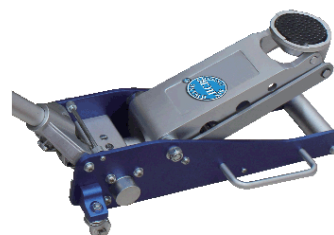

- 極輕、高強度的鋁合金千斤頂，非常方便使用。
- 雙活塞設計，可以非常快速的上升至最高高度。
- 密封式油封，可有效避免髒汙進入油壓缸內。
- 安全防過載系統，可避免使用超過其最大負載力。
- 可更換式橡膠頂座可避免刮損車輛並防止滑動。
- 最低高度僅 95 mm! 可用於狹小的空間內。
- 規格：
最低高度 (mm): 95 mm
最高高度 (mm): 440 mm

H.C.B-A2344

NEW

2 TONS HYDRAULIC TROLLEY JACK

2 噸油壓千斤頂

- Rugged steel frame construction
- 360 degrees rotating saddle
- 2 rear swivel casters for easy positioning
- Handle for raising and positioning
- Excellent stability.
- Multipurpose floor jack for car or heavy-duty lifting jobs.
- Specifications :
Min. Height (mm): 135 mm
Max. Height (mm): 385 mm



- 旋轉式頂座可 360 度旋轉，以便於任何角度使用。
- 後 2 輪可 360 度旋轉，方便移動及調整位置。
- 此千斤頂用途廣泛，可用於汽車維修或重型舉升作業。
- 規格：最低高度 (mm): 135 mm
最高高度 (mm): 385 mm

H.C.B-A2355

NEW

TRUCK TRANSMISSION JACKS (CAPACITY: 1000 KGS)

卡車變速箱千斤頂 (負載 : 1000 KGS)

- Fully adjustable universal saddle with adjustable corner brackets and safety chain.
- Bracket and chain slings are adjustable to accommodate transmissions ,clutches and differentials of varying sizes.
- Wide base with four 3-1/2" dia. swivel casters provide stability and easy maneuvering .
- Safety bypass system prevents the Jack form being over extended beyond its rated capacity.
- Rugged support design to provide greater stability .

- 此千斤頂有可調整的踏板與安全鏈條讓使用者擁有一個安全的工作環境
- 支架與鏈條可調節，以適用不同尺寸的變速箱，離合器和差速器。
- 有著四個 3-1 / 2" 寬底座。穩固且滑順的旋轉腳讓使用者更易於操縱。
- 透過系統可防止千斤頂超出其可負載的能力。
- 堅固的支撐設計，提供更高的穩定性。

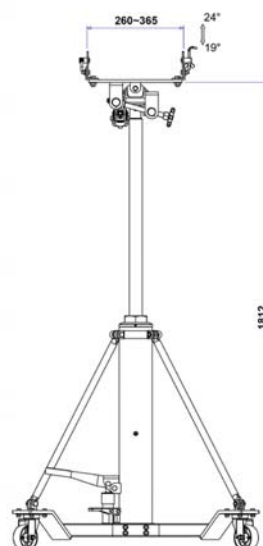
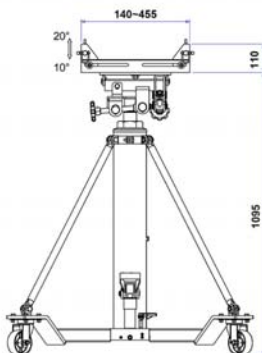
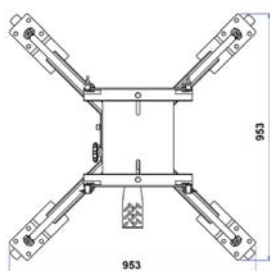

H.C.B-A2337

NEW

WHEEL NUT TWIST SOCKET KIT (4 PCS)

破壞型螺旋套筒及延伸桿 (4 PCS)

- Features:
- 1. This Dr. 1/2" twist socket is specially designed for theremoval of locking wheel nuts.
- 2. This tool has 6 point and the other side with 6 point twist.
- 3. This tool can be also used while a nut could not be loosen in a normal way because of rust or deformation.
- 4. This socket set is made of SCM440 with HRC 46-49 degree.

- 1. 此 Dr. 1/2" 套筒特別設計用於拆卸防盜螺絲。
- 2. 此套筒為一邊為 6 角，另一邊為螺旋之 6 角。
- 3. 若螺絲已生鏽、變形導致無法以正常方式拆卸時，也可使用此工具鬆開。
- 4. 此套筒組材質均為 SCM440，硬度達 HRC 46-49。

nut fragment.

SAFETY PRECAUTION
•DO NOT use the impact driver.





SINCE 1990

**HWANG CHERNG BIN
Specialty Tools Inc.**

氣動工具
AIR TOOL



H.C.B-B2005

1/2" AIR IMPACT WRENCH

1/2" 氣動扳手 (下排式)

- Specification / 規格:
- Square drive (方榫) ----- 1/2"
- Free speed (無轉載速) ----- 6,800 RPM
- AVG air consumption (耗氣量) ----- 0.15 m³/min (5.30 cfm)
- Max torque (最大扭力) ----- 800 FT/LBS
- Length (長度) ----- 190 mm
- Weight (重量) ----- 1.9 kgs



H.C.B-B2005-1

1/2" AIR IMPACT WRENCH (WITH 10 PCS SOCKET)

1/2" 氣動扳手 (下排式, 含套筒)

- Specification / 規格:
- Square drive (方榫) ----- 1/2"
- Free speed (無轉載速) ----- 6,800 RPM
- AVG air consumption (耗氣量) ----- 0.15 m³/min (5.30 cfm)
- Max torque (最大扭力) ----- 800 FT/LBS
- Length (長度) ----- 190 mm
- Specification of socket (套筒尺寸):
- 1: 27 mm 6: 17 mm
- 2: 24 mm 7: 14 mm
- 3: 22 mm 8: 13 mm
- 4: 21 mm 9: 12 mm
- 5: 19 mm 10: 10 mm



H.C.B-B2025

3/8" AIR MINI RATCHET WRENCH

3分氣動棘輪扳手

- Specification / 規格:
- Free Speed (轉速) ----- 240 RPM
- Max. Torque (最大扭力) --- 18 呎 - 磅 (ft-lbs)
- Net Weight (淨重) ----- 0.6 kg
- Overall Length (全長) ----- 178 mm
- Air Inlet (進氣口規格) ----- 1/4"
- Hose Size (風管規格) ----- 3/8"



H.C.B-A2034

1/4" 90° AIR STUBBY AIR RATCHET WRENCH

1/4" 90° 氣動扳手

- Specification / 規格:
- Square drive (方榫) ----- 1/4"
- Free Speed (無載轉速) ----- 240 RPM
- Max. torque (最大扭力) ----- 18 ft-lbs(24 NM)
- Air inlet (進氣口) ----- 1/4" NPT
- Air pressure bar (空壓) ----- 90 psi
- Air consumption (耗氣量) ----- 3 CFM
- Weight (重量) ----- 1.1 lbs (0.55 kgs)
- Overall length (總長) ----- 6-5/16"



H.C.B-A2046

1/2" 90° STUBBY AIR RATCHET WRENCH

1/2" 90° 氣動扳手

- Specification / 規格 :
- Square drive (方樺) ----- 1/2"
- Free Speed (無載轉速) ----- 150 RPM
- Max. torque (最大扭力) ----- 60 ft-lbs
- Air inlet (進氣口) ----- 1/4" NPT
- Weight (重量) ----- 2.86 lbs (1.3 kgs)
- Overall length (總長) ----- 10" (254 mm)



H.C.B-A2047

AIR DIE GRINDER

氣動刻模機



H.C.B-A2048

16 PCS AIR DIE GRINDER KIT

氣動刻模機組 (16PCS)



H.C.B-A2139

1/2" MINI IMPACT WRENCH

1/2" 輕型氣動扳手

- Specification / 規格 :
- Square drive (方樺) ----- 1/2"
- Bolt size (螺栓能力) ----- 14 mm
- Free Speed (無載轉速) ----- 12500 RPM
- Max. torque (最大扭力) ----- 300 ft-lbs
- Overall length (總長) ----- 145 mm
- Air inlet (進氣口) ----- 1/4" NPT
- Hose (氣管) ----- 3/8"
- Weight (重量) ----- 1.5kgs

Item	SQ.	Bolt Size	Speed	Torque	Length
H.C.B-A2139	1/2"	14mm	12500	300ft/ib	145mm

Item	Inlet	Hose	CFM	L/Min	Weight
H.C.B-A2139	1/4"	3/8"	3	85	1.50kg



H.C.B-A2173

1/2" 90° AIR RATCHET WRENCH

1/2" 90° 氣動棘輪扳手

- Specification / 規格 :
- Square drive (方榫) ----- 1/2"
- Free speed (無轉載速) ----- 160 RPM
- Max torque (最大扭力) ----- 55 FT/LBS(7.6KGM)
- Air inlet (進氣口) ----- 1/4" NPT
- Air consumption (耗氣量) ----- 3 CFM (L/min)
- Overall length (總長) ----- 9-3/8" (238 mm)
- Weight (重量) ----- 2.52 lbs (1.14 kgs)



H.C.B-A2200

3/4" IMPACT WRENCH

3/4" 氣動扳手

- Specification / 規格 :
- Square drive (方榫) ----- 3/4" (19 mm)
- Free speed (無轉載速) ----- 5000 rpm
- Max torque (最大扭力) ----- 1250 ft-lbs (1695 Nm) / 1695 牛頓·米
- Bolt Capacity (螺栓能力) ----- 1-1/4" (32 mm)
- Net weight (淨重) ----- 9.6 lbs (4.3 kgs)
- Overall length (總長) ----- 8.5" (217 mm)
- Avg. Air consumption (平均耗氣量) --- 3 CFM (L/min)
- Air inlet (進氣口) ----- 3/8" NPT
- Air pressure bar (空壓) ----- 90 psi (6.3 kg/cm²)
- Sound level (音壓) ----- 96 dBA

VIDEO



H.C.B-B2200

3/4" ALUMINUM HOUSING IMPACT WRENCH

3/4" 鋁合金氣動扳手

- Specification / 規格 :
- Free speed (轉速) ----- 5,800 rpm
- Max.torque @ 90 psi (最大扭力) ----- 1,750 ft-lb/ 2373 nm
- Net weight (淨重) ----- 13.50 lbs (6.10kgs)
- Overall length (全長) ----- 228 mm (9.0 inch)
- Air inlet (進氣孔規格) ----- 3/8 inch
- Air hose id (風管規格) ----- 1/2 inch
- Average.Air consumption (耗氣量) --- 2271 l/min
- Lpa (聲壓) ----- 105 dBA
- Work pressure (工作壓力) ----- 90 psi



H.C.B-A2285

1/2" MINI COMPOSITE IMPACT WRENCH (JAMBO HAMMER)

4分塑膠手柄迷你單環捶打式衝擊扳手

- Specification / 規格 :
- Free Speed (轉速) ----- 9,500 RPM
- Max. Torque (最大扭力) ----- 500 呎 - 磅 (ft-lbs), 678 Nm
- Net Weight (淨重) ----- 1.15 kg
- Overall Length (全長) ----- 112 mm
- Air Inlet (進氣口規格) ----- 1/4"
- Hose Size (風管規格) ----- 3/8"



H.C.B-A2286

1/2" COMPOSITE IMPACT WRENCH (TWIN HAMMER)

4 分塑膠手柄雙環捶打式衝擊扳手

- Specification / 規格 :
- Free Speed (轉速) ----- 7,300 RPM
- Max. Torque (最大扭力) ---- 800 呎 - 磅 (ft-lbs), 1,085 Nm
- Net Net Weight (淨重) ---- 2.0 kg
- Overall Length (全長) ---- 175 mm
- Air Inlet (進氣口規格) ----- 1/4"
- Hose Size (風管規格) ----- 3/8"



H.C.B-B2286

3/8" COMPOSITE IMPACT WRENCH (TWIN HAMMER) 475 NM

3 分塑膠手柄雙環捶打式衝擊扳手 (扭力 475 牛頓米)

- Specification / 規格 :
- Free Speed (轉速) ----- 7,000 RPM
- Max. Torque (最大扭力) --- 380 呎 - 磅 (ft-lbs), 515 Nm
- Net Weight (淨重) ----- 1.29 kg
- Overall Length (全長) ---- 150 mm
- Air Inlet (進氣口規格) ----- 1/4"
- Hose Size (風管規格) ----- 3/8"



H.C.B-A2287

3/4" COMPOSITE IMPACT WRENCH (TWIN HAMMER)

6 分塑膠手柄雙環捶打式衝擊扳手

- Specification / 規格 :
- Free Speed (轉速) ----- 7,300 RPM
- Max. Torque (最大扭力) -- 1,400 呎 - 磅 (ft-lbs), 1,898 Nm
- Net Weight (淨重) ----- 3.3 kg
- Overall Length (全長) ---- 202 mm
- Air Inlet (進氣口規格) ----- 3/8"
- Hose Size (風管規格) ----- 1/2"



H.C.B-A2326

10.8 V CORDLESS IMPACT WRENCH (3/8")

10.8 V 充電式衝擊扳手 (3/8")

- Specification (規格)
- Voltage (電壓)-----DC 10.8 V
- Unloaded Speed (無負載轉速)-----0 ~ 2400 RPM
- Max Torque (最大鬆脫扭力)-----100 Nm (885 in-lbs)
- Weight (with 2.0 Ah Battery) (重量 (含 2.0 Ah 電池包))---1090 g

Charger (充電座)

- Input Voltage (輸入電壓)-----AC 100-120 V 50/60 Hz
- Output Voltage (輸出電壓)-----DC 15 V 1.2 A
- Charging Time (充電時間)-----90 min (分鐘)

- Battery pack (電池包)
- Voltage (伏特數)-----10.8 V
- Capacity Cell Type (容量)-----2.0 Ah Li-ion (鋰電)



H.C.B-A3036

AIR HYDRAULIC PUMP (1600 c.c.) (Dr. 3/8" ADAPTOR)

氣動幫浦 (1600 c.c.)(3/8" 接頭)

- Application: 10~30 tons ■ 適用範圍: 10~30 噸
- 接頭尺寸: 3/8" NPT x 1.5M x 3/8" NPT

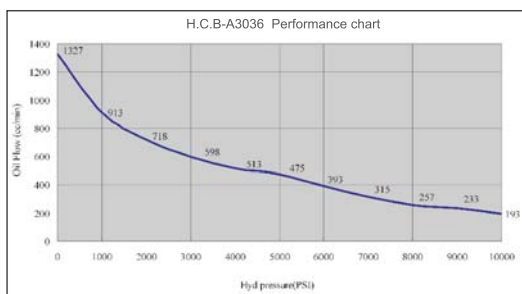

Sound level test	80 dba/m
N.W.	8.32 KGS
G.W.	8.5 KGS
CUFT	0.8'
Oil reservoir capacity	1600 c.c.
Hyd. pressure (PSI)	0 1000 2000 3000 4000 5000 6000 7000 8000 9000 10000
Oil flow (c.c./min)	1327 913 718 598 513 475 393 315 257 233 193

H.C.B-B3036

AIR HYDRAULIC PUMP (1800 c.c.)

氣動幫浦 (1800 c.c.)

- Application: 10~30 tons ■ 適用範圍: 10~30 噸



Hyd. pressure (PSI)	0	1000	2000	3000	4000	5000	6000	7000	8000	9000	10000
Oil flow (c.c./min)	1170	970	850	700	600	515	440	370	315	250	195
Model Number	Oil Capacity (c.c.)	Pressure Rating (psi)	Air Pressure Range (kg/cm ²)	Dimensions L*W*H(mm)	Sound Level Test (dba/m)	N.W. (Kgs)	G.W. (Kgs)				
H.C.B-B3036	1800	10000	7 ~ 10	310*144*208.5	80	10.2	10.7				

H.C.B-C3036

DOUBLE HOSE AIR HYDRAULIC PUMP (3800 c.c.)

雙管幫浦 (3800 c.c.)

- Oil reservoir capacity: 3800 c.c. ■ 適用範圍: 3800 c.c.

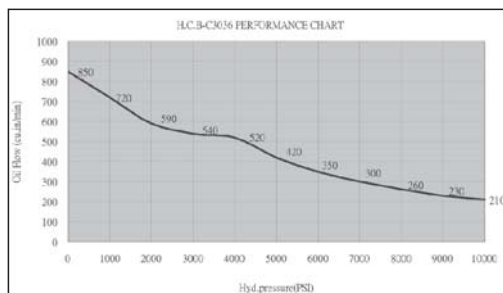

Pressure (psi)	0	1000	2000	3000	4000	5000	6000	7000	8000	9000	10000
Oil Flow (c.c./min)	850	720	590	540	520	420	350	300	260	230	210
Item no.	Oil Capacity (c.c.)	Pressure Rating (psi)	Air Pressure Range (kg/cm ²)	Dimensions LxWxH(mm)	Sound Level Test (dba/m)	N.W. (Kgs)	G.W. (Kgs)	CUFT			
H.C.B-C3036	3800	10000	7-10	470x147x210	80	11.6	12.6	1			

H.C.B-D3036

DOUBLE HOSE AIR HYDRAULIC PUMP (3800 c.c.)

氣動 / 油壓幫浦 (7600c.c.)

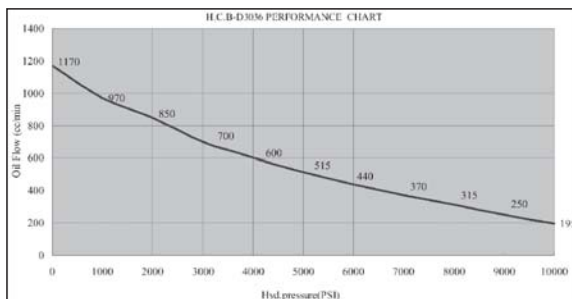

inflow
1/4"-18NPT

outflow
3/8"-18NPT



Pressure (psi)	0	1000	2000	3000	4000	5000	6000	7000	8000	9000	10000
Oil Flow (c.c./min)	1170	970	850	700	600	515	440	370	315	250	195

Item no.	Oil Capacity (c.c.)	Pressure Rating (psi)	Air Pressure Range (kg/cm ²)	Dimensions LxWxH (mm)	Sound Level Test (dba/m)	N.W. (Kgs)	G.W. (Kgs)	Cuft
H.C.B-D3036	7600	10000	7-10	352x269x250	80	22	23	1

H.C.B-E3036

AIR / HYDRAULIC FOOT PUMP (2000 c.c.) (WITHOUT HOSE)

氣動 / 油壓幫浦 (2000 c.c.) (不含管)

Intended use:

- For automotive / truck, industrial & construction jobs.
- The added convenience of an air motor reduces pumping time and effort to activate cylinders.

Features

- Designed to utilize exhaust air to help power the pump, requiring only 80 p.s.i. air pressure to develop 10,000 p.s.i. hydraulic pressure.
- Air exhaust muffler for quieter operation.
- Air and oil inlet filters for reduced risk of damage from contamination.
- Designed to be used with a single-acting cylinder.
- Foot pedal provides hands free pumping and release of load.
- Internal pressure relief valve for overload protection.
- Equipped with a more durable aluminum reservoir.
- Comes with two different size poppit valves that can be quickly and easily installed. Poppit valves reduce the return flow of oil back to the pump's reservoir providing a safer controlled lowering of load.



MODEL NUMBER	HYDRAULIC PRESSURE RATING (P.S.I.)	USABLE OIL CAP. (Cu. In.)	OUTPUT FLOW RATE (Cu. In. Per Min.)		AIR PRESSURE RANGE (P.S.I.)	AIR CONSUMPTION (scfm)	VALVE FUNCTION	SOUND LEVEL (dBA)	THREAD CONNECTIONS		DIMENSIONS (Inches)			WEIGHT (Lbs.)
			No Load	Load					AIR (NPT)	HYDRAULIC (NPT)	Length	Width	Height	
E3036	10,000	122	80.5	12.8	40-170	24	Advance / Hold Retract	85	.25"-18	.375"-18	12.5	5.75	8	22

H.C.B-F3036

AIR/HYDRAULIC PUMP (WITHOUT HOSE) 6.2-6.8 BAR AIR PRESSURE / PUMP230-245 BAR

氣動 / 油壓幫浦 (不含管)

INTENDED USE:

- For automotive, truck, industrial & construction jobs.
- The added convenience of an air motor reduces pumping time and effort to activate cylinders.

Features:

- Designed with durable light weight, corrosion resistant plastics.
- Equipped with a more durable aluminum reservoir.

應用範圍:

- 可使用在車上·卡車·工業或建築上
- 氣動的馬達可加快幫浦作動的時間·使用上更有效率

特色:

- 使用重量輕、抗腐蝕的塑膠設計
- 配有更耐用的鋁製儲油區



H.C.B-G3036

HIGH PRESSURE MANOMETER (15,000 PSI)

高壓力錶 (15,000 PSI)

- Manometer for H.C.B air pump 3036 series.
- For monitoring hydraulic pressure.
- Maximum detection pressure is 15,000 psi.



H.C.B-A3036
is equipped with H.C.B-G3036

H.C.B-A2350

NEW

GEARLESS ANGLE IMPACT WRENCH (3/8")

氣動彎頭衝擊扳手 (無齒輪) (3/8")

H.C.B-B2350

NEW

GEARLESS ANGLE IMPACT WRENCH (1/2")

氣動彎頭衝擊扳手 (無齒輪) (1/2")

- Easy to work in confined work spaces, short and stubby with 88 mm x 248 mm.
- Low reaction force
- Lightweight: 1.4 Kg
- Max. torque: 350 ft.lb. (475 Nm) in reverse
- Compared with geared angle impact, the gearless angle impact reduce vibration by 50%, increase torque output by 20%. 360° swivel exhaust.
- Designed for small & medium vehicle engine bay area and under-lift nut tightening and loosening application, it is very ideal tool to deal with any limited working space.
- Rubber-made head protective sleeve.
- Sensitive trigger enable the Multi-Speed control. One-piece back cover design for easier repairing of motor parts and impact mechanism.
- Ergonomic composite handle design offers great gripping comfort.



- 易於在狹窄的工作空間內工作 · 88 mm x 248 mm。
- 反作用力低
- 重量：1.4Kg
- 最大扭矩：350 ft.lb. (475 牛) 反向
- 與有齒輪角度的工具相比，無齒輪角度減少 50% 的振動，扭矩輸出增加 20%，360° 旋轉。
- 特別設計給小型與中型車輛引擎，在有限空間維修是非常理想工具。
- 頭部保護套為橡膠製
- 具靈敏性佳的扳機可控制不同速度
- 一體的設計便於修理電機部件和衝擊機制
- 擁有符合人體工學設計的複合手柄設計，並提供極佳的握把舒適性。

MODEL	SQUARE DRIVE INCH	FREE SPEED R.P.M	MAX TORQUE @5 SEC. ft.lb.(Nm)	OVERALL LENGTH INCH(mm)	AIR INLET (INCH)	AIR HOSE I.D	AVG.AIR CONSUMPTION cfm(L/min)	NET WEIGHT lb(kg)
A2350	3/8"	6,500	250(339)	9.8(248)	1/4"	3/8"	4.2(119)	2.98(1.35)
B2350	1/2"	6,500	300(407)	9.8(248)	1/4"	3/8"	4.2(119)	3.09(1.40)

H.C.B-A2269

1" SQ DR. HEAVY DUTY IMPACT WRENCH

1" 氣動扳手

- Specification:
- Drive Size-----1"Sq
- Free Speed----- 3000 rpm
- Working Max Torque@5sec---- 3390 Nm (2500 ft-lb)
- Overall Length ----- 436mm (17.2 inch)
- Air Inlet-----1/2 inch
- Air Hose ID -----3/4 inch
- Average. Air Consumption----411 L/min
- Net Weight-----34.84 lb (15.8 KGS)



H.C.B-A2270

1" SQ DR. EXTRA HEAVY DUTY IMPACT WRENCH, LONG ANVIL

1" 長軸氣動扳手

- Specification:
- Drive Size-----1"Sq
- Free Speed----- 3000 rpm
- Working Max Torque@5sec---- 3390 Nm (2500 ft-lb)
- Overall Length ----- 634mm (25 inch)
- Air Inlet-----1/2 inch
- Air Hose ID -----3/4 inch
- Average. Air Consumption ----411 L/min
- Net Weight -----37.04 lb (16.8 KGS)



VIDEO

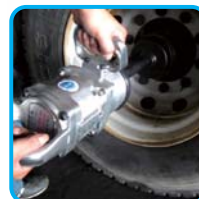



SINCE 1990

HWANG CHERNG BIN
Specialty Tools Inc.

一
般
修
護
工
具
修
護
設
備

GENERAL REPAIR EQUIPMENT



H.C.B-A1073

3 - SHELF SERVICE CART (STAINLESS)

三層不銹鋼工具車

- Thickness: 1.5 mm
- Size: 1050 x 400 x 780 mm
- The open up tool cart to place repair tools.

- 厚度：1.5 mm
- 尺寸：1050 x 400 x 780 mm
- 開放式的工具車



H.C.B-C1076

11 - DRAWER ROLLER CABINET

11 抽工具車

- Product Dimension:
OVERALL: 660 mm (W) x 307 mm (D) x 374 mm (H)
3 DRAWERS: 170 mm (W) x 275 mm (D) x 50 mm (H)
2 DRAWERS: 569 mm (W) x 275 mm (D) x 50 mm (H)
1 DRAWER: 569 mm (W) x 275 mm (D) x 75 mm (H)
N.W.: 25.4 KGS, G.W.: 28.4 KGS, CUFT: 3.97'
- Top: 660 mm (W) x 307 mm (D) x 251mm (H)
2 DRAWERS: 569 mm (W) x 275 mm (D) x 50 mm (H)
1 DRAWER: 569 mm (W) x 275 mm (D) x 75 mm (H)
N.W.: 13 KGS, G.W.: 15.5 KGS, CUFT: 2.7'
- Bottom: 670 mm (W) x 460 mm (D) x 812 mm (H)
OVERALL WITH 5" CASTERS:
670 mm (W) x 460 mm (D) x 960 mm (H)
5 DRAWERS: 576 mm (W) x 380 mm (D) x 75 mm (H)
2 DRAWERS: 576 mm (W) x 380 mm (D) x 154 mm (H)
N. W.: 64 KGS, G.W.: 72 KGS, CUFT: 12.24'



H.C.B-A1135-R

THE COMPACT TOOLBOX TROLLEY (RED)

美式工具車 (紅)

- OVERALL: 780 mm (W) x 520 mm (D) x 890 mm (H)
- OVERALL WITH 4" CASTERS:
780 mm (W) x 520 mm (D) x 1020 mm (H)
2 DRAWERS: 298 mm (W) x 445 mm (D) x 81 mm (H)
1 DRAWER: 628 mm (W) x 445 mm (D) x 81 mm (H)
1 DRAWER: 628 mm (W) x 445 mm (D) x 127 mm (H)
(1) BALL BEARING SLIDE
(2) 4" x 11/4" CASTERS (2 SWIVEL + 2 SEIVEL W/BRAKE)



H.C.B-A1541 **DIGITAL CALIPER**

極速卡尺

- Measuring Range:
0-6"/150 mm, 0-8"/200 mm, 0-12"/300 mm
- Resolution: 0.0005"/0.01 mm
- Accuracy:
6"/150 mm:±0.001"/±0.02 mm, 12"/150 mm:±0.0015"/±0.04 mm
- 量測範圍：
0-6"/150 mm, 0-8"/200 mm, 0-12"/300 mm
- 解析度：0.0005"/0.01 mm
- 準確度：
6"/150 mm:±0.001"/±0.02 mm, 12"/150 mm:±0.0015"/±0.04 mm



H.C.B-A2001 **3 - SHELF SERVICE CART**

3 層工具車

1 / 21.5 / 23.5 / 4.3'

- For garage, office, warehouse service.
- Two or three sturdy 2" deep trays with red enamel paint.
- 4 large 3" swivel casters and two with brakes device.
- Easy assembly and use.
- It is coming with 1 piece of tools holder.
- Capacity: 150KGS
- Specification: W: 750 mm X D: 440 mm X H: 960 mm



(Tools are NOT included)

- 適用於修車廠、辦公室和倉庫。
- 3 層紅色烤漆 2 吋深的托盤。
- 4 個 3 吋腳輪，其中 2 個附有煞車。
- 方便組裝與使用。
- 配備有工具架。
- 載重：150 公斤
- 尺寸：750mm(寬) x 440mm(深) x 960mm(高)



■ Delivery without tools

H.C.B-A2010 **FOUR - SHELF CART**

工具車 (4 層開放式附間隔塊)

- The open up tool cart to place repair tools.
- Specification:
W: 550 mm x D: 480 mm x H: 900 mm

- 開於式的工具車
- 尺寸：550mm(寬) x 480mm(深) x 900 mm(高)



H.C.B-A2011

TOOL BOX, 6 DRAWERS (MODEL 300)

6 抽工具車 (300 型)

- The drawers are equipped with ball bearings to increase the carrying capacity.
- The drawers are equipped with ball bearings which make it convenient to take the drawers out.
- Specification: W: 560 mm X D: 460 mm X H: 910 mm

- 配備滾珠培林抽屜的鐵櫃，可提高耐重量。
- 滾珠培林式的抽屜，方便將整個抽屜取出。
- 尺寸：560mm(寬) x 460mm(深) x 910mm(高)



H.C.B-F2060

3 - DRAWER DOUBLE SIDED TROLLEY

3 抽雙開工具車

- This trolley is equipped with the laptop panel which can place the laptop on and helps do diagnosis service or software tuning.
- Double sided design makes it more convenient to take out the tools.
- Dimensions: Overall:
765 mm (W) × 490 mm (D) × 948 mm (H)
Overall plus the 4" casters:
765 mm (W) × 490 mm (D) × 1050 mm (H)
1 drawer: 576 mm (W) × 415 mm (D) × 75 mm (H)
2 drawers: 576 mm (W) × 415 mm (D) × 154 mm (H)

- 此工具車上配有筆記型電腦座，可放置筆電以便於進行車輛系統診斷或車輛軟體調整。
- 雙開設計，可從任一邊拿取工具，讓使用上更為方便。
- 規格：
工具車尺寸：765 mm (長) × 490 mm (寬) × 948 mm (高)
工具車加上 4" 腳輪之尺寸：
765 mm (長) × 490 mm (寬) × 1050 mm (高)
抽屜一尺寸：576 mm (長) × 415 mm (寬) × 75 mm (高)
抽屜二尺寸：576 mm (長) × 415 mm (寬) × 154 mm (高)



H.C.B-A2060	TOOL BOX, 7 DRAWERS ROLLER CART (BALL BEARING SLIDE)
H.C.B-B2060	WALL CABINET (W: 660 mm x D: 305 mm x H 600 mm)
H.C.B-C2060	TOP TRAY
H.C.B-D2060	(18") SIDE PANEL



H.C.B-A2060
TOOL BOX, 7 DRAWERS ROLLER CART (BALL BEARING SLIDE)
7 抽工具車

- Size (WxDxH): 26.3"x 18" x 32" (670x460x813 mm)
- 尺寸：670 mm(寬) x 460 mm(深) x 600mm(高)

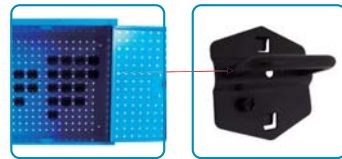

H.C.B-B2060
WALL CABINET
工具壁櫃

- Size: W: 660 mm x D: 305 mm x H 600 mm
- 尺寸：寬：660 mm x 深：305 mm x 高：600mm



H.C.B-C2060
TOP TRAY
上方膠盤

H.C.B-D2060
(18") SIDE PANEL
(18") 側板

- Turn the top of your A2060 series roll cabinet into a work/storage bench with one of these heavy duty tray tops. Also protects the top of your roll cabinet. Features include: sturdy handles, a large tray area, screwdriver slots, front & side storage wells.
- 此膠盤放置壁櫃的上方，可保護壁櫃上方避免撞擊，並多出可利用空間。
- 特點：有堅固的手柄與大托盤，前方與側邊有凹槽可以擺放個人平常使用的小工具，使工具不易滑落。

■ A2060 系列工具車方便收納，其特點包括：堅固的手柄，一個大托盤區，螺絲刀槽，壁櫃可以吊掛工具及側邊可以吊掛擦手紙。

H.C.B-E2060

14 DRAWER ROLLER TOOL CABINETS

14 抽滾輪工具櫃

- This sturdy tool storage cabinet consists of heavy duty ball bearing slides on all its drawers for smooth drawing.
- This tool storage cabinet have enough drawer space for you to put the tools which you usually use.
- The drawers can be locked to prevent the drawers from falling out.
- 此工具車有偌大的儲存工具的抽屜，您可以依照自己所常用的工具來擺設
- 4 個輪子讓你可輕鬆移動此工具車。
- 是你在車庫間的好幫手。
- 抽屜可上鎖，避免抽屜因搖晃而散落。



H.C.B-A1051-1

PUNCHED BOARD (885 mm x 870 mm)

洞洞板 (3 尺 x 3 尺)

- The board is designed for hanging up the tools.
- Specification: 885 mm x 870 mm
- NW: 11KGS GW: 12.3 KGS
- 特別設計來吊掛工具
- 規格：885 mm x 870 mm
- 淨重：11 公斤 毛重：12.3 公斤



- Delivery without tools
- 不含工具

H.C.B-A1051-2

PUNCHED BOARD (L 1800 mm x W 865 mm x H 20 mm)

洞洞板 (長 1800 mm x 寬 865 mm x 高 20 mm)

- The board is designed for hanging up the tools.
- Specification: L1800 mm x W865 mm x H20mm
- NW: 26KGS GW: 29 KGS
- 特別設計來吊掛工具
- 規格：長 1800 mm x 寬 865 mm x 高 20 mm
- 淨重：26 公斤 毛重：29 公斤

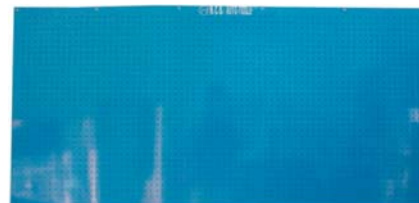

H.C.B-A1051-3

3" FIXED HOOK

3" 洞洞勾



H.C.B-A1051-4

PUNCHED BOARD (561 mm x 866 mm x 20 mm)

洞洞板 (561 mm x 866 mm x 20 mm)

- The board is designed for hanging up the tools.
- Specification: L561 mm x W866 mm x H20mm
- NW: 5.21KGS
- 特別設計來吊掛工具
- 規格：長 561mm x 寬 866 mm x 高 20 mm
- 淨重：5.21 公斤



Keep your tools tidy, keep your work tidy.



H.C.B-C1051

TOOL CABINET

壁櫃

- Manufactured from heavy steel plate for extra strength and durability.
- Superb quality and 2 lockable door wall cabinet.
- It combines easy access and tool storage with security.
- Dimensions: W: 900 mm D: 215 mm H: 1000 mm



























- 厚規格鋼板製造可增加強度與耐久性。
- 具有精湛品質且有上鎖功能的櫥櫃，是保養廠技工的最佳儲物櫃！
- 多孔設計可方便拿取與存放。
- 規格：寬：900 mm 深：215 mm 高：1000 mm



H.C.B-C1051-001

(Tools are NOT included)

- 不含工具

ITEM NO	C1051-002	C1051-003	C1051-004	C1051-005	C1051-006	C1051-007	
Description	TOOL HOOK inclined hook end	TOOL HOOK inclined hook end	TOOL HOLDER vertical hook end	TOOL HOLDER double,vertical hook end	TOOL HOLDER double,vertical hook end	TOOL HOOK inclined hook end	
PHOTO							
Q'TY	6	5	1	2	3	2	
ITEM NO	C1051-008	C1051-009	C1051-010	C1051-011	C1051-012	C1051-013	C1051-014
TOOL HOOK for wrench	TOOL HOLDER double,vertical hook end	TOOL HOLDER double,vertical hook end	SPRING CLAMP	Ø4 x 50 L TOOL HOLDER for wrench	Tool holder for screwdrivers	ROUND HOLDER	
							
1	12	1	2	3	1	1	
ITEM NO	C1051-015	C1051-016	C1051-017	C1051-018	C1051-019	C1051-020	C1051-021
Socket holder	Socket holder	Socket holder	Socket holder	Socket holder	Socket holder	Tool holder for screwdrivers	Tool holder for screwdrivers
							
1	2	1	1	1	2	3	
ITEM NO	C1051-022	C1051-023	C1051-024	C1051-025	C1051-026	C1051-027	
Tool holder for toque wrench	Tool holder for screwdrivers	Tool holder	Drill-bit holder With 5 holes	TOOL HOLDER double, vertical hook end	clamp		
							
2	1	2	1	14	100		

H.C.B-D1051

TOOL CABINET

工具櫃

- Dimensions:
W: 900 mm, D: 215 mm, H: 1000 mm
- Options:
Special color and design are available on request.
- 規格：寬：900 x 深：215 x 高：1000 mm
- 可客製特殊顏色和設計
- 不包含工具



Delivery without tools

H.C.B-A2283

Dr. 1/2" DEEP IMPACT SOCKET KIT (13 PCS) (10/11/12/13/14/16/17/19/21/22/24/27/30 mm)

Dr. 1/2" 長型氣動套筒組 (13 PCS) (10/11/12/13/14/16/17/19/21/22/24/27/30 mm)

- Size: 10 mm, 11 mm, 12 mm, 13 mm, 14 mm, 16 mm, 17 mm, 19 mm, 21 mm, 22 mm, 24 mm, 27 mm, 30 mm
- 尺寸：:10 mm, 11 mm, 12 mm, 13 mm, 14 mm, 16 mm, 17 mm, 19 mm, 21 mm, 22 mm, 24 mm, 27 mm, 30 mm



H.C.B-A2230

Dr. 3/4" TX-STAR & SPLINE IMPACT BIT SOCKET KIT (6 PCS)

Dr. 3/4" 氣動星形 12 角凸型套筒組 (6 PCS)

10/18.2/18.7/0.72'

- TX-Star: T70, T80, T90, T100
- ★ Spline: M16, M18
- Length: 61 mm
- Material: CR-MO
- M16 Application: Touareg Phaeton from 2003
- M18 Application: Touran 2004. Audi A3 from 2004



H.C.B-B2230

3/4" SQ. DRIVE HEXAGON & SPLINE IMPACT BIT SOCKET KIT (9 PCS) (61 mm) (14/17/19/21/22/23/24 mm/M16/M18)

Dr. 3/4" 氣動 6 角 & 12 角套筒組 (9 PCS) (61 mm) (14/17/19/21/22/23/24 mm/M16/M18)

- Material: CR-MO with special blue finish or manganese phosphate
- Overall Length: 61 mm
- Size: Hexagon: 14, 17, 19, 21, 22, 23, 24 mm
Spline: M16, M18
- Suitable for using with any impact tool.
- 全長: 61 mm
- 尺寸: 六邊形: 14, 17, 19, 21, 22, 23, 24 mm
方形: M16, M18
- 可搭配氣動工具使用



H.C.B.-C2230

3/4" SQ. DRIVE HEXAGON & TX-STAR IMPACT BIT SOCKET KIT (9 PCS) (61 mm) (19/21/22/23/24 mm/T70/80/90/100)

Dr. 3/4" 氣動星形 12 角凸型套筒組 (9 PCS) (61 mm)
(19/21/22/23/24 mm/T70/80/90/100)

- Material : CR-MO with special blue finish or manganese phosphate
- Overall Length: 61 mm
- Size: Hexagon: 19, 21, 22, 23, 24 mm
Star: T70, T80, T90, T100
- 全長 : 61 mm
- 尺寸 : 六邊形 : 19, 21, 22, 23, 24 mm
星形 : T70, T80, T90, T100
- 可搭配氣動工具使用



H.C.B.-B2138

WORKING TABLE (CABINET)

美式工作桌 (加壁櫃)

- W: 1525 x D: 700 x H: 1520
- 12 mm, block fiberboard
- Toerate the hammer beating without destroying the surface and the structure.
- Take round angle for preventing from wounded.
- The length is suitable to hang on and take out.



H.C.B.-B2138-1

FIXED HOOK

壁櫃掛鉤

ITEM NO.	SIZE(INCH)
B2138-1-A	1"
B2138-1-B	2"
B2138-1-C	4"
B2138-1-D	8"



H.C.B.-A2316

MECHANICS CREEPER

臥板

- Made from durable, rust-proof fiberglass.
- Comfortable ergonomic shape.
- Six wheels (hard rubber for smooth operation).
- Convenient tool trays.
- Easy-to-clean surface.
- Dimensions: 104.5 x 517 mm.
- 耐用、防銹玻璃纖維製成。
- 舒適的人體工學造型。
- 六個輪子 (硬質橡膠讓運作更順利)。
- 工具托盤讓你方便放置物品。
- 易於清潔的表面。
- 尺寸 : 104.5 x 517 mm



H.C.B-A2317

THREADED COIL-INSERT REPAIR KIT (130 PCS)

螺紋修護組 (130 PCS)

■ Specification:

M6×1.0
M8×1.25
M10×1.25
M10×1.5
M12×1.25

- | | |
|---------------------|----------------------|
| (25) M5 coils | (1) M6 tang puncher |
| (25) M6 coils | (1) M8 tang puncher |
| (25) M8 coils | (1) M10 tang puncher |
| (25) M10 coils | (1) M12 tang puncher |
| (10) M12 coils | (1) M5 drill bit |
| (1) M5 tap | (1) M6 drill bit |
| (1) M6 tap | (1) M8 drill bit |
| (1) M8 tap | (1) M10 drill bit |
| (1) M10 tap | (1) M12 drill bit |
| (1) M12 tap | (1) Metal case |
| (1) M5 tang puncher | |



H.C.B-A2319

2 WAY AIR DUSTER

二用風槍

- Flow control knob to adjust air speed.
- Interchangeable short nozzle and 4-1/2" in. Long nozzle is optional.
- Nozzles can be used in standard pistol grip mode as well as from the top of the gun for access into tight spots.
- Ergonomic grip, lightweight.

- 有流量控制旋鈕可調整風速
- 可依照需求更換兩種尺寸的噴嘴 (長:4-1/2" in.)
- 噴嘴可裝在標準的噴槍上·也可以裝在噴槍上端
- 優點:符合人體工學的握把·工具重量輕巧·方便使用。



H.C.B-A2322

SPARK PLUG PLIERS (3 PCS)

火星塞鉗 (3 PCS)

- Applications:
Made from CR-MO material.
Suitable for using on hoses, spark plug wires, etc...

■ Specification:

Item No.	∅	Length
A2322-08	8 mm(5/16")	11"
A2322-13	13 mm(1/2")	11"
A2322-19	19 mm(3/4")	11"

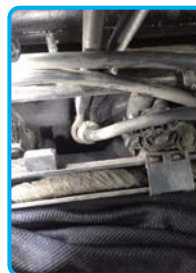

H.C.B-A6005-5

TOOL HOLDER (5 SLICES)

工具櫃 (五片)



ITEM NO.	Description
A6005-3	3 silces
A6005-4	4 silces
A6005-5	5 silces
A6005-8	8 silces

- Easy to install, remove and transport.
- Small size, double hooks which can hang a variety of tools.
- 1.5 mm thick plate which is solid and untransformable.
- Color and size are customizable.
- 易於安裝和拆卸，運輸體積小
- 雙面掛鉤，可以掛各種工具
- 板子厚度 1.5 mm，堅固結實，不易變型
- 可根據客戶要求做尺寸和顏色

H.C.B-A6006

MAGNETIC STAND W/GAUGE

磁性座含錶

- This high quality base has a very strong magnet (50-lb force) which can mount to flat or round surfaces at any angle firmly and is easily activated with a convenient on-and-off switch.
- Product Dimensions: 10.8" x 4.1" x 2.8"
- VOLVO OEM no. ref.: 9989876/999696
- 此高品質的磁性座配有非常強力的磁鐵 (50 磅的磁力)，可以任何角度吸附在平面或圓形表面上，且磁性座上面有一個 ON/ OFF 的開關，可以輕鬆開關磁鐵。
- 尺寸：10.8" x 4.1" x 2.8"
- Volvo 原廠號碼：9989876/999696





HWANG CHERNG BIN Specialty Tools Inc. National Tools trade show



**FRANKFURT
AUTOMECHANIKA SHOW**



**ITALY AUTOPROMOTEC
SHOW**



FRANCE EQUIP AUTO SHOW



TAIWAN AMPA SHOW



RUSSIA MIMS SHOW



**MIDDLE EAST
AUTOMECHANIKA SHOW**



USA AAPEX SHOW



**POZNAN TTM
AUTOMOTIVE SHOW**



KOREA KOAA SHOW



JAPAN IAAE SHOW



UK BIRMINGHAM SHOW





SINCE 1990

HWANG CHERNG BIN Specialty Tools Inc.



**PICTURE TAKEN WITH LEBANON
CLIENT IN 2009 AMPA SHOW**



**PICTURE TAKEN WITH ISRAEL CLIENT IN
2014 AUTOMECHANIKA SHOW FRANKFURT**



**PICTURE TAKEN WITH CYPRUS
CLIENT IN 2010
AUTOMECHANIKA SHOW FRANKFURT**



**PICTURE TAKEN WITH MALAYSIA
CLIENT IN 2014 AMPA**



**PICTURE TAKEN WITH NEW ZEALAND
CLIENT IN 2014 AAPEX**



**PICTURE TAKEN WITH GERMANY
CLIENT IN 2010
AUTOMECHANIKA SHOW FRANKFURT**



SINCE 1990

HWANG CHERNG BIN
Specialty Tools Inc.



PICTURE TAKEN WITH AUSTRALIAN CLIENT IN 2015 AMPA SHOW



PICTURE TAKEN WITH INDONESIAN CLIENT IN 2008 AMPA SHOW



PICTURE TAKEN WITH JAPANESE CLIENT IN 2009 AMPA SHOW



PICTURE TAKEN WITH POLAND CLIENT IN 2014 AUTOMECHANIKA SHOW FRANKFURT



AUSTRALIAN CLIENT VISITED H.C.B COMPANY



PICTURE TAKEN WITH HONG KONG CLIENT IN 2012 AMPA SHOW



HWANG CHERNG BIN
Specialty Tools Inc.

SINCE 1990

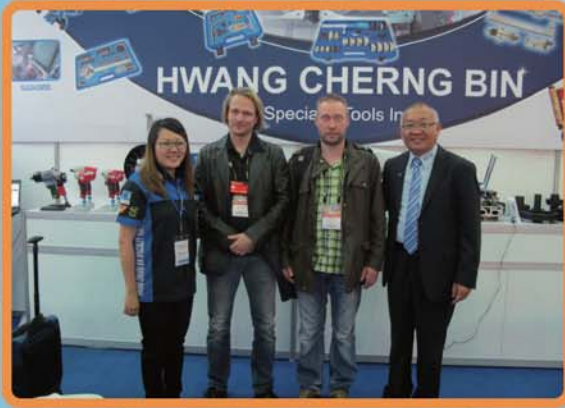

**PICTURE TAKEN WITH FINLAND
CLIENT IN 2015 AMPA SHOW**



**PICTURE TAKEN WITH FINLAND
CLIENT IN 2014 AUTOMECHANIKA
SHOW FRANKFURT**



**PICTURE TAKEN WITH CHINA CLIENT
IN 2012 AUTOMECHANIKA
SHOW FRANKFURT**



**PICTURE TAKEN WITH IRELAND
CLIENT IN 2012 AUTOMECHANIKA
SHOW FRANKFURT**



**PICTURE TAKEN WITH LITHUANIA
CLIENT IN 2012 AUTOMECHANIKA
SHOW FRANKFURT**



**PICTURE TAKEN WITH KOREAN
CLIENT IN 2013 KOAA SHOW**

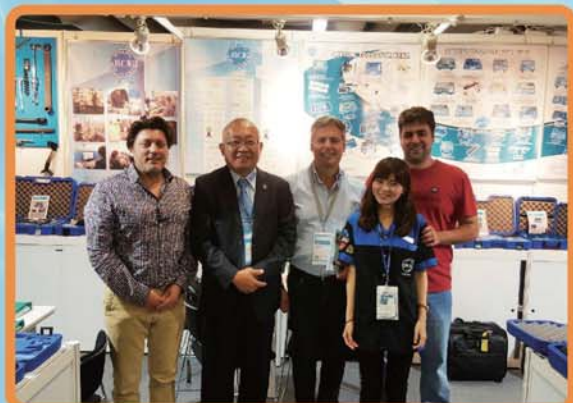

**PICTURE TAKEN WITH ITALY CLIENT IN
2016 AUTOMECHANIKA SHOW FRANKFURT**



H.C.B hosting National Conference seminar for Department of Automobile Technique

H.C.B 舉辦全國汽車科教師研習營

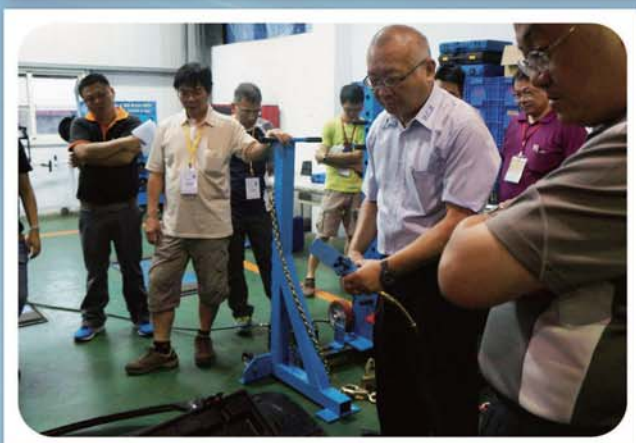
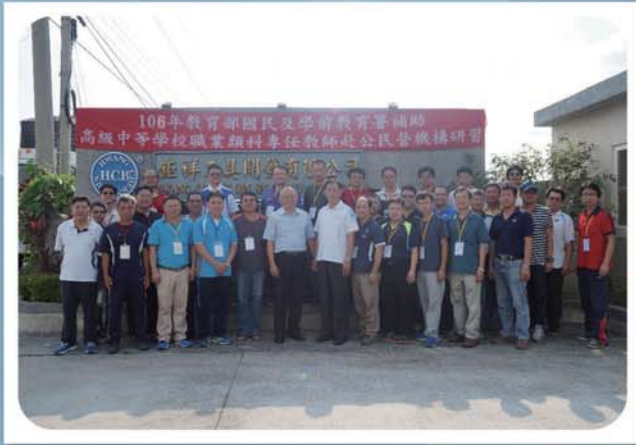

生活在感恩的世界

Living on a grateful world

感激斥責你的人

因為他助長了你的定慧

Be grateful to those who have denounced you,
for they have increased your wisdom and concentration.

感激絆倒你的人

因為他強化了你的能力

Be grateful to those who have made you stumble,
for they have strengthened your ability.

感激遺棄你的人

因為他教導了你應自立

Be grateful to those who have abandoned you,
for they have taught you to be independent.

感激鞭打你的人

因為他消除了你的業障

Be grateful to those who have hit you,
for they have reduced your karmic obstacles,

感激欺騙你的人

因為他增進了你的見識

Be grateful to those who have deceived you,
for they have deepened your insight.

感激傷害你的人

因為他磨練了你的心志

Be grateful to those who have hurt or harmed you,
for they have reinforced your determination.

感激所有使你堅定成就的人

**Be grateful to those who have made you firm &
resolute and helped in your achievement.**



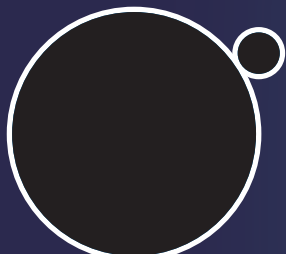

SINCE 1990

HWANG CHERNG BIN SPECIALTY TOOLS INC.
No.25-120, Shiyizhicuo, Longder Village,
Shuishang Township, Chiayi County, 60859,
Taiwan, R.O.C.
TEL:886-5-2603816,886-5-2600820
FAX:886-5-2603817, Order FAX:886-5-2601595
E-mail: hcb@hcb-autotools.com.tw
service@hcb-autotools.com.tw

www.hcb-autotools.com

Location: 23.43001N, 120.38757E



201903